

# Dell Pro 14 Essential

PV14250

Owners Manual

## Notes, cautions, and warnings

 **NOTE:** A NOTE indicates important information that helps you make better use of your product.

 **CAUTION:** A CAUTION indicates either potential damage to hardware or loss of data and tells you how to avoid the problem.

 **WARNING:** A WARNING indicates a potential for property damage, personal injury, or death.

|   |           |
|---|-----------|
| <b>Chapter 1: Views of Dell Pro 14 Essential PV14250</b>          | <b>8</b>  |
| Right   | 8         |
| Left  | 8         |
| Top   | 9         |
| Front   | 10        |
| Bottom  | 11        |
| Service Tag   | 12        |
| Battery-status light  | 12        |
| <b>Chapter 2: Set up your Dell Pro 14 Essential PV14250</b>       | <b>13</b> |
| <b>Chapter 3: Specifications of Dell Pro 14 Essential PV14250</b> | <b>15</b> |
| Dimensions and weight   | 15        |
| Processor   | 15        |
| Chipset   | 16        |
| Operating system  | 16        |
| Memory  | 16        |
| External ports and slots  | 17        |
| Internal slots  | 17        |
| Wireless module   | 17        |
| Audio   | 18        |
| Storage   | 18        |
| Media-card reader   | 19        |
| Keyboard  | 19        |
| Keyboard shortcuts  | 19        |
| Camera  | 21        |
| Touchpad  | 21        |
| Battery   | 21        |
| Power requirements  | 22        |
| Power adapter   | 23        |
| Power adapter requirements of Dell Pro 14 Essential PV14250       | 24        |
| Display   | 24        |
| Fingerprint reader (optional)                                     | 25        |
| Sensors   | 26        |
| GPU—Integrated  | 26        |
| External display support  | 26        |
| Hardware security   | 26        |
| Operating and storage environment                                 | 26        |
| Dell support policy   | 27        |
| Dell low blue light display                                       | 27        |
| ComfortView Plus  | 27        |
| <b>Chapter 4: Working inside your computer</b>                    | <b>29</b> |
| Safety instructions   | 29        |

|   |           |
|---|-----------|
| Before working inside your computer.....  | 29        |
| Safety precautions.....   | 30        |
| Electrostatic discharge—ESD protection.....   | 30        |
| ESD Field Service kit .....   | 31        |
| Transporting sensitive components.....  | 32        |
| After working inside your computer.....   | 32        |
| BitLocker.....  | 32        |
| Recommended tools.....  | 33        |
| Screw list.....   | 33        |
| Major components of Dell Pro 14 Essential PV14250.....  | 35        |
| Customer Replaceable Units (CRUs) and Field Replaceable Units (FRUs) list.....                | 37        |
| <b>Chapter 5: Base cover.....</b>   | <b>38</b> |
| Removing the base cover for computers shipped with a plastic chassis.....                     | 38        |
| Installing the base cover for computers shipped with a plastic chassis.....                   | 40        |
| Removing the base cover for computers shipped with an aluminum chassis.....                   | 42        |
| Installing the base cover for computers shipped with an aluminum chassis.....                 | 44        |
| <b>Chapter 6: Battery.....</b>  | <b>47</b> |
| Rechargeable Li-ion battery precautions.....  | 47        |
| Removing the 41 W battery for computers shipped with a plastic chassis.....                   | 47        |
| Installing the 41 W battery for computers shipped with a plastic chassis.....                 | 48        |
| Removing the 54 W battery for computers shipped with a plastic chassis.....                   | 49        |
| Installing the 54 W battery for computers shipped with a plastic chassis.....                 | 50        |
| Removing the 54 W battery for computers shipped with an aluminum chassis.....                 | 51        |
| Installing the 54 W battery for computers shipped with an aluminum chassis.....               | 52        |
| Disconnecting the battery cable .....   | 53        |
| Connecting the battery cable .....  | 54        |
| <b>Chapter 7: Removing and installing Customer Replaceable Units (CRUs).....</b>              | <b>56</b> |
| Memory module.....  | 56        |
| Removing the memory module for computers shipped with a plastic chassis.....                  | 56        |
| Installing the memory module for computers shipped with a plastic chassis.....                | 57        |
| Removing the memory module for computers shipped with an aluminum chassis.....                | 59        |
| Installing the memory module for computers shipped with an aluminum chassis.....              | 60        |
| Solid-state drive.....  | 61        |
| Removing the M.2 2230 solid-state drive for computers shipped with a plastic chassis.....     | 61        |
| Installing the M.2 2230 solid-state drive for computers shipped with a plastic chassis.....   | 62        |
| Removing the M.2 2230 solid-state drive for computers shipped with an aluminum chassis.....   | 63        |
| Installing the M.2 2230 solid-state drive for computers shipped with an aluminum chassis..... | 64        |
| Wireless card.....  | 65        |
| Removing the wireless card for computers shipped with a plastic chassis.....                  | 65        |
| Installing the wireless card for computers shipped with a plastic chassis.....                | 66        |
| Removing the wireless card for computers shipped with an aluminum chassis.....                | 68        |
| Installing the wireless card for computers shipped with an aluminum chassis.....              | 69        |
| System fan.....   | 70        |
| Removing the system fan for computers shipped with a plastic chassis.....                     | 70        |
| Installing the system fan for computers shipped with a plastic chassis.....                   | 71        |
| Removing the system fan for computers shipped with an aluminum chassis.....                   | 72        |

|   |    |
|---|----|
| Installing the system fan for computers shipped with an aluminum chassis..... | 73 |
|---|----|

**Chapter 8: Removing and installing Field Replaceable Units (FRUs)..... 75**

|   |     |
|---|-----|
| Heat sink.....  | 75  |
| Removing the heat sink.....   | 75  |
| Installing the heat sink.....   | 76  |
| Power-adapter port.....   | 77  |
| Removing the power-adapter port for computers shipped with a plastic chassis.....                       | 77  |
| Installing the power-adapter port for computers shipped with a plastic chassis.....                     | 78  |
| Removing the power-adapter port for computers shipped with an aluminum chassis.....                     | 79  |
| Installing the power-adapter port for computers shipped with an aluminum chassis.....                   | 80  |
| I/O board.....  | 81  |
| Removing the I/O board for computers shipped with a plastic chassis.....                                | 81  |
| Installing the I/O board for computers shipped with a plastic chassis.....                              | 82  |
| Removing the I/O board for computers shipped with an aluminum chassis.....                              | 83  |
| Installing the I/O board for computers shipped with an aluminum chassis.....                            | 84  |
| Power button with fingerprint reader.....   | 85  |
| Removing the power-button with fingerprint reader for computers shipped with a plastic chassis.....     | 85  |
| Installing the power-button with fingerprint reader for computers shipped with a plastic chassis.....   | 86  |
| Removing the power-button with fingerprint reader for computers shipped with an aluminum chassis.....   | 87  |
| Installing the power-button with fingerprint reader for computers shipped with an aluminum chassis..... | 88  |
| Touchpad.....   | 90  |
| Removing the touchpad for computers shipped with a plastic chassis.....                                 | 90  |
| Installing the touchpad for computers shipped with a plastic chassis.....                               | 91  |
| Removing the touchpad for computers shipped with an aluminum chassis.....                               | 93  |
| Installing the touchpad for computers shipped with an aluminum chassis.....                             | 94  |
| Speakers.....   | 95  |
| Removing the speakers for computers shipped with a plastic chassis.....                                 | 95  |
| Installing the speakers for computers shipped with a plastic chassis.....                               | 96  |
| Removing the speakers for computers shipped with an aluminum chassis.....                               | 98  |
| Installing the speakers for computers shipped with an aluminum chassis.....                             | 99  |
| Display assembly.....   | 101 |
| Removing the display assembly for computers shipped with a plastic chassis.....                         | 101 |
| Installing the display assembly for computers shipped with a plastic chassis.....                       | 102 |
| Removing the display assembly for computers shipped with an aluminum chassis.....                       | 104 |
| Installing the display assembly for computers shipped with an aluminum chassis.....                     | 106 |
| Display bezel.....  | 108 |
| Removing the display bezel for computers shipped with a plastic chassis.....                            | 108 |
| Installing the display bezel for computers shipped with a plastic chassis.....                          | 111 |
| Display panel.....  | 113 |
| Removing the display panel for computers shipped with a plastic chassis.....                            | 113 |
| Installing the display panel for computers shipped with a plastic chassis.....                          | 116 |
| Display cable.....  | 119 |
| Removing the display cable for computers shipped with a plastic chassis.....                            | 119 |
| Installing the display cable for computers shipped with a plastic chassis.....                          | 120 |
| Camera.....   | 122 |
| Removing the camera for computers shipped with a plastic chassis.....                                   | 122 |
| Installing the camera for computers shipped with a plastic chassis.....                                 | 122 |

|   |            |
|---|------------|
| Display back-cover and antenna assembly.....  | 123        |
| Removing the display back-cover and antenna assembly .....  | 123        |
| Installing the display back-cover and antenna assembly .....                                      | 124        |
| System board.....   | 125        |
| Removing the system board for computers shipped with a plastic chassis.....                       | 125        |
| Installing the system board for computers shipped with a plastic chassis.....                     | 129        |
| Removing the system board for computers shipped with an aluminum chassis.....                     | 132        |
| Installing the system board for computers shipped with an aluminum chassis.....                   | 136        |
| Palm-rest and keyboard assembly.....  | 139        |
| Removing the palm-rest and keyboard assembly for computers shipped with a plastic chassis.....    | 139        |
| Installing the palm-rest and keyboard assembly for computers shipped with a plastic chassis.....  | 140        |
| Removing the palm-rest and keyboard assembly for computers shipped with an aluminum chassis....   | 141        |
| Installing the palm-rest and keyboard assembly for computers shipped with an aluminum chassis.... | 143        |
| <b>Chapter 9: Software.....</b>   | <b>145</b> |
| Operating system.....   | 145        |
| Drivers and downloads.....  | 145        |
| <b>Chapter 10: BIOS Setup.....</b>  | <b>146</b> |
| Entering BIOS Setup program.....  | 146        |
| Navigation keys.....  | 146        |
| F12 One Time Boot menu.....   | 146        |
| System setup options.....   | 147        |
| Updating the BIOS.....  | 160        |
| Updating the BIOS in Windows.....   | 160        |
| Updating the BIOS using the USB drive in Windows.....   | 161        |
| Updating the BIOS in Linux and Ubuntu.....  | 162        |
| Updating the BIOS from the One-Time boot menu.....  | 162        |
| System and setup password.....  | 162        |
| Assigning a System Setup password.....  | 162        |
| Deleting or changing an existing system password or setup password.....                           | 163        |
| Clearing system and setup passwords.....  | 163        |
| <b>Chapter 11: Troubleshooting.....</b>   | <b>164</b> |
| Handling swollen rechargeable Li-ion batteries.....   | 164        |
| Dell SupportAssist Pre-boot System Performance Check diagnostics.....                             | 164        |
| Running the SupportAssist Pre-Boot System Performance Check.....                                  | 165        |
| Built-in self-test (BIST).....  | 165        |
| Motherboard Built-In Self-Test (M-BIST).....  | 165        |
| Logic Built-in Self-test (L-BIST).....  | 166        |
| LCD Built-in Self-Test (LCD-BIST).....  | 166        |
| System-diagnostic lights.....   | 166        |
| Recovering the operating system.....  | 167        |
| Real-Time Clock (RTC Reset).....  | 167        |
| Backup media and recovery options.....  | 168        |
| Network power cycle.....  | 168        |
| Drain flea power (perform hard reset).....  | 168        |
| <b>Chapter 12: Getting help and contacting Dell.....</b>  | <b>170</b> |

**Chapter 13: Revision history..... 171**

# Views of Dell Pro 14 Essential PV14250

## Right



Figure 1. Right view

### 1. SD-card slot

Reads from and writes to the SD card. The computer supports the following card types:

- Secure Digital (SD)
- Secure Digital High Capacity (SDHC)
- Secure Digital Extended Capacity (SDXC)

### 2. Headset (headphone and microphone combo) port

Connect headphones or a headset (headphone and microphone combo).

### 3. USB 3.2 Gen 1 (5 Gbps) port

Connect devices such as external storage devices and printers. Provides data transfer speeds up to 5 Gbps.

### 4. Wedge-shaped lock slot

Connect a security cable to prevent unauthorized movement of your computer.

## Left



Figure 2. Left view

### 1. Power-adaptor port



Connect your power-adaptor.

## 2. Battery-status light

Indicates the battery-charge status.

- Solid yellow-Battery charge is low.
- Blinking yellow-Battery charge is critical.

## 3. HDMI 1.4 port

Connect to a TV, external display, or another HDMI-in enabled device. Provides video and audio output.

## 4. USB 3.2 Gen 1 (5 Gbps) port

Connect devices such as external storage devices and printers. Provides data transfer speeds up to 5 Gbps.

## 5. USB 3.2 Gen 2 (10 Gbps) Type-C with Power Delivery and DisplayPort

Supports DisplayPort 1.4, which enables you to connect to an external display using a display adapter. Provides data transfer rates of up to 10 Gbps.

**NOTE:** A USB Type-C to DisplayPort adapter (sold separately) is required to connect a DisplayPort device.

# Top

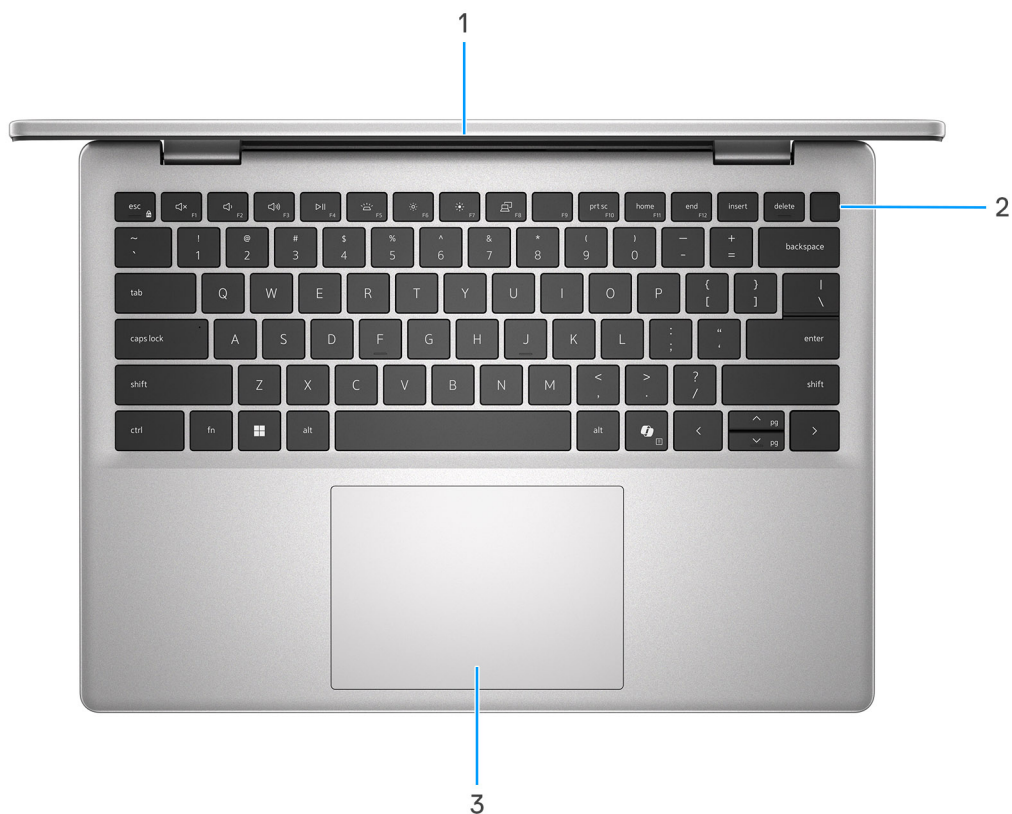

**Figure 3. Top view**

## 1. Display

Displays the data, videos, and photos.

## 2. Fingerprint reader (optional)

Press your finger on the fingerprint reader to log in to your computer. The fingerprint reader enables your computer to recognize your fingerprints as a password.

**i** **NOTE:** Configure the fingerprint reader to register your fingerprint and enable access.

### 3. Touchpad

Move your finger on the touchpad to move the mouse pointer. Tap to left-click and two fingers tap to right-click.

## Front

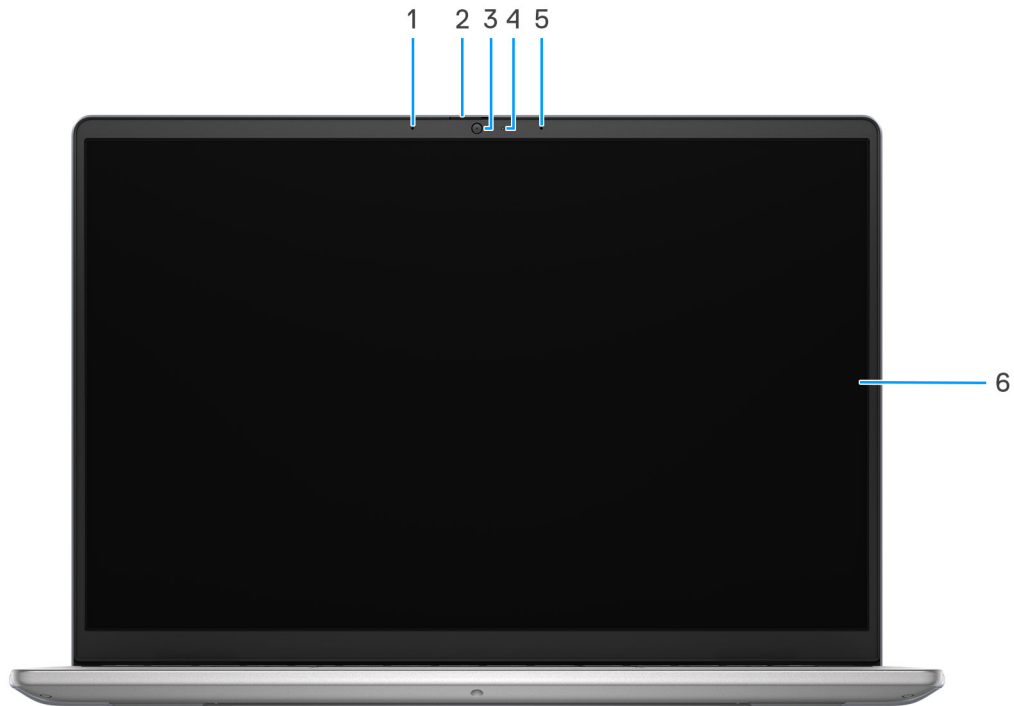

**Figure 4. Front view**

#### 1. Left microphone

Provides digital sound input for audio recording and voice calls.

**i** **NOTE:** Computers that are shipped with plastic chassis have only one microphone.

#### 2. Camera shutter

Slide the privacy shutter to the left to access the camera lens.

**i** **NOTE:** The camera shutter is only available on computers that are shipped with an aluminum chassis.

#### 3. Camera

Enables you to video chat, capture photos, and record videos.

#### 4. Camera-status light

Turns on when the camera is in use.

#### 5. Right microphone

Provides digital sound input for audio recording and voice calls.

**NOTE:** Computers that are shipped with plastic chassis have only one microphone.

## 6. Display

Displays the data, videos, and photos.

# Bottom

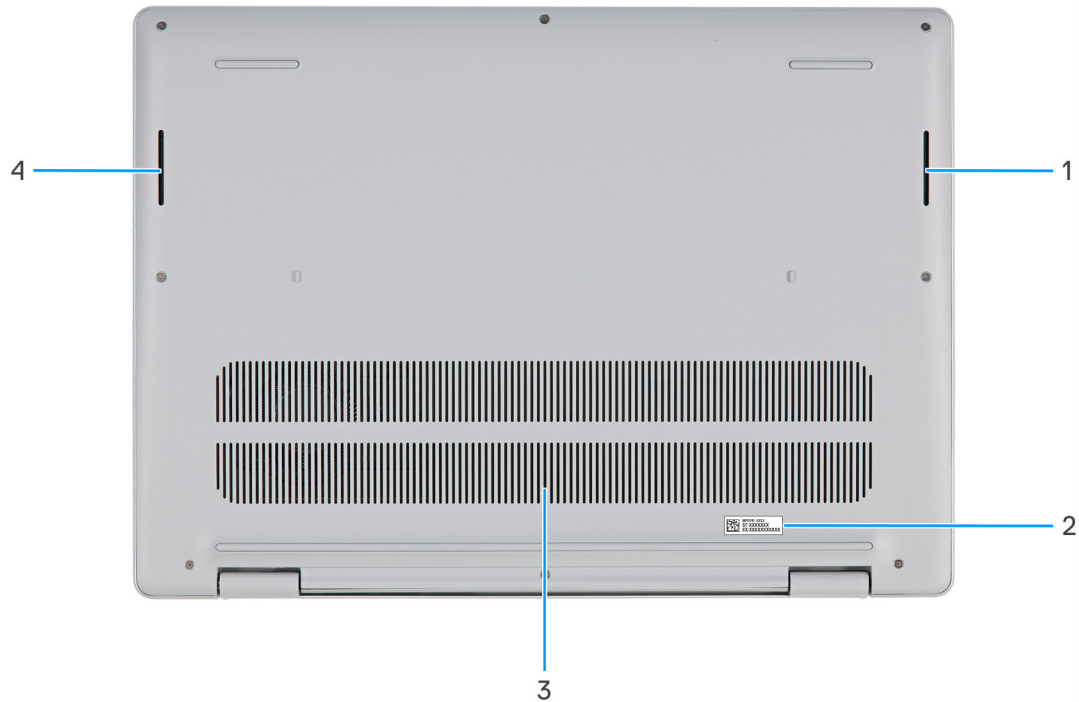

**Figure 5. Bottom view**

### 1. Right speaker

Provide audio output.

### 2. Service Tag label

The Service Tag is a unique alphanumeric identifier that enables Dell service technicians to identify the hardware components in your computer and access warranty information.

### 3. Air vents

Air vents provide ventilation for your computer. Clogged air vents can cause overheating and can affect your computer's performance and potentially cause hardware issues. Keep the air vents clear of obstructions and clean them regularly to prevent the build-up of dust and dirt. For more information about cleaning air vents, search for articles in the Knowledge Base Resource at [Dell Support Site](#).

### 4. Left speaker

Provide audio output.

# Service Tag

The service tag is a unique alphanumeric identifier that allows Dell service technicians to identify the hardware components in your computer and access warranty information.

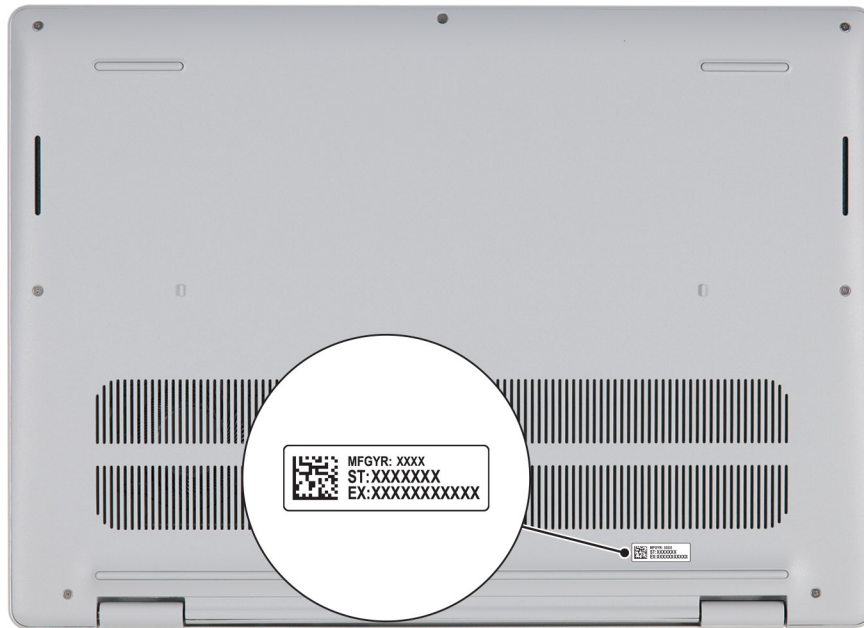

Figure 6. Service Tag location

# Battery-status light

The following table lists the battery-status light of your Dell Pro 14 Essential PV14250.

Table 1. Battery-status light behavior

| Power source | LED behavior | System power state | Battery charge level |
|--------------|--------------|--------------------|----------------------|
| AC adapter   | Off          | S0 or S5           | 100%                 |
| AC adapter   | Solid white  | S0 or S5           | < 100%               |
| Battery      | Off          | S0 or S5           | 11-100%              |
| Battery      | Solid amber  | S0 or S5           | < 10%                |

- S0 (ON): The computer is turned on.
- S3 (Sleep): Screen is off and computer is in sleep mode.
- S4 (Hibernate): The computer consumes the least power in the Hibernate state than in the ON or OFF state. The computer is almost in the OFF state. The context data is written to a storage device, allowing you to resume from where you left after the computer is turned on.
- S5 (OFF): The computer is in a shutdown state.

# Set up your Dell Pro 14 Essential PV14250

## About this task

**NOTE:** The images in this document may differ from your computer depending on the configuration you ordered.

## Steps

1. Connect the power adapter and press the power button.



**Figure 7. Connect the power adapter and press the power button.**

**NOTE:** The battery may go into storage mode during shipment to conserve charge on the battery. Ensure that the power adapter is connected to your computer when it is turned on for the first time. For more information about battery storage mode, see the knowledge base article at [Dell Support Site](#).

2. Finish the operating system setup.

### For Ubuntu:

Follow the on-screen instructions to complete the setup. For more information about installing and configuring Ubuntu, search in the Knowledge Base Resource at [Dell Support Site](#).

### For Windows:

Follow the on-screen instructions to complete the setup. When setting up, Dell Technologies recommends that you:





- Connect to a network for Windows updates.

**NOTE:** If connecting to a secured wireless network, enter the password for the wireless network access when prompted.

- If connected to the Internet, sign in with or create a Microsoft account. If not connected to the Internet, create an offline account.

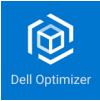
- On the **Support and Protection** screen, enter your contact details.
3. Locate and use Dell apps from the Windows Start menu—Recommended.

**Table 2. Locate Dell apps**

| Resources   | Description   |
|---|---|
|  | <p>Dell Optimizer is an application designed to enhance computer performance and productivity by optimizing settings for power, battery, display, collaboration touchpad, and presence detection. It also provides access to applications purchased with your new computer.</p> <p>For more information, see Dell Optimizer User's Guide at <a href="#">Dell Support Site</a>.</p>  |
|  | <p><b>Dell Product Registration</b></p> <p>Register your computer with Dell.</p>  |
|  | <p><b>Dell Help &amp; Support</b></p> <p>Access help and support for your computer.</p>   |
|  | <p><b>SupportAssist</b></p> <p>SupportAssist is a proactive and predictive technology that offers automated technical support for Dell computers. It proactively monitors both hardware and software, addressing performance issues, preventing security threats, and automating engagement with Dell Technical Support.</p> <p>For more information, see the SupportAssist documentation at <a href="#">Dell Support Site</a>.</p> <p><b>NOTE:</b> In SupportAssist, click the warranty expiry date to renew or upgrade your warranty.</p> |

# Specifications of Dell Pro 14 Essential PV14250

## Dimensions and weight

The following table lists the height, width, depth, and weight of your Dell Pro 14 Essential PV14250.

**Table 3. Dimensions and weight**

| Description   | Aluminum chassis           | Plastic chassis       |
|---|----------------------------|-----------------------|
| Height:   |                            |                       |
| Front height  | 0.62 in. (15.86 mm)        | 16.90 mm (0.67 in.)   |
| Rear height   | 0.68 in. (17.31 mm)        | 18.07 mm (0.71 in.)   |
| Width   | 12.36 in. (314.00 mm)      | 314.00 mm (12.36 in.) |
| Depth   | 8.90 in. (226.15 mm)       | 226.15 mm (8.90 in.)  |
| Weight<br> <b>NOTE:</b> The weight of your computer depends on the configuration that you ordered. | Maximum: 3.64 lb (1.65 kg) | 1.69 kg (3.73 lb)     |

## Processor

The following table lists the details of the processors that are supported on your Dell Pro 14 Essential PV14250.

**Table 4. Processor**

| Description         | Option one                 | Option two                 | Option three               | Option four                |
|---------------------|----------------------------|----------------------------|----------------------------|----------------------------|
| Type                | 13th Gen Intel Core 3-100U | 13th Gen Intel Core 5-120U | 13th Gen Intel Core 5-220U | 13th Gen Intel Core 7-150U |
| Wattage             | 15 W                       | 15 W                       | 15 W                       | 15 W                       |
| Core count          | 6                          | 10                         | 10                         | 10                         |
| Thread count        | 8                          | 12                         | 12                         | 12                         |
| Speed               | Up to 4.70 GHz             | Up to 5.00 GHz             | Up to 5.00 GHz             | Up to 5.4 GHz              |
| Cache               | 10 MB                      | 10 MB                      | 10 MB                      | 12 MB                      |
| Integrated graphics | Intel Iris Xe Graphics     | Intel Iris Xe Graphics     | Intel Iris Xe Graphics     | Intel Iris Xe Graphics     |

# Chipset

The following table lists the details of the chipset that is supported by your Dell Pro 14 Essential PV14250.

**Table 5. Chipset**

| Description    | Values  |
|----------------|---|
| Chipset        | Integrated in the processor   |
| Processor      | <ul style="list-style-type: none"><li>13th Generation Intel Core 3/5/7 processors</li></ul> |
| DRAM bus width | 64-bit  |
| Flash EPROM    | 32 MB   |
| PCIe bus       | Up to Gen 3   |

# Operating system

Your Dell Pro 14 Essential PV14250 supports the following operating systems:

- Windows 11 Home
- Windows 11 Pro
- Windows 11 Pro National Academic
- Ubuntu Linux 22.04 LTS, 64-bit

# Memory

The following table lists the memory specifications that are supported by your Dell Pro 14 Essential PV14250.

**Table 6. Memory specifications**

| Description                     | Values   |
|---------------------------------|--|
| Memory slots                    | Two-SODIMM slots   |
| Memory type                     | DDR5, dual-channel   |
| Memory speed                    | <ul style="list-style-type: none"><li>5200 MT/s</li></ul>  |
| Maximum memory configuration    | 32 GB  |
| Minimum memory configuration    | 8 GB   |
| Memory size per slot            | 8 GB   |
| Memory configurations supported | <ul style="list-style-type: none"><li>8 GB: 1 x 8 GB, DDR5, 5200 MT/s, single-channel</li><li>16 GB: 1 x 16 GB, DDR5, 5200 MT/s, single-channel</li><li>16 GB: 2 x 8 GB, DDR5, 5200 MT/s, dual-channel</li><li>32 GB: 1 x 32 GB, DDR5, 5200 MT/s, single-channel</li><li>32 GB: 2 x 16 GB, DDR5, 5200 MT/s, dual-channel</li></ul> |



## External ports and slots

The following table lists the external ports and slots on your Dell Pro 14 Essential PV14250.

**Table 7. External ports and slots**

| Description         | Values  |
|---------------------|---|
| USB ports           | <ul style="list-style-type: none"><li>Two USB 3.2 Gen 1 (5 Gbps) ports</li><li>One USB 3.2 Gen 2 (10 Gbps) Type-C with Power Delivery and DisplayPort™ 1.4 port</li></ul> |
| Audio port          | One headset (headphone and microphone combo) port   |
| Video port(s)       | One HDMI 1.4 port<br><b>NOTE:</b> HDMI output supports up to 1920x1080 @ 60Hz, 24bpp. No 4K/2K output supported.  |
| Media-card reader   | One SD-card slot  |
| Power-adaptor port  | 4.5 mm barrel   |
| Security-cable slot | One wedge-shaped lock slot  |

## Internal slots

The following table lists the internal slots of your Dell Pro 14 Essential PV14250.

**Table 8. Internal slots**

| Description | Values  |
|-------------|---|
| M.2         | <ul style="list-style-type: none"><li>One M.2 2230 slot for WiFi and Bluetooth combo card</li><li>One M.2 2230 slot for solid state drive</li></ul> <b>NOTE:</b> To learn more about the features of different types of M.2 cards, search <a href="#">Dell Support Site</a> . |

## Wireless module

The following table lists the Wireless Local Area Network (WLAN) module that is supported on your Dell Pro 14 Essential PV14250.

**Table 9. Wireless module specifications**

| Description               | Values  |
|---------------------------|---|
| Model number              | Realtek RTL8852BE   |
| Transfer rate             | Up to 1201 Mbps   |
| Frequency bands supported | 2.4 GHz/5 GHz   |
| Wireless standards        | <ul style="list-style-type: none"><li>Wi-Fi 802.11 a/b/g</li><li>Wi-Fi 4 (WiFi 802.11n)</li><li>Wi-Fi 5 (WiFi 802.11ac)</li><li>Wi-Fi 6 (WiFi 802.11ax)</li></ul> |

**Table 9. Wireless module specifications (continued)**

| Description   | Values   |
|---|--|
| Encryption  | <ul style="list-style-type: none"> <li>64-bit/128-bit WEP</li> <li>AES-CCMP</li> <li>TKIP</li> </ul> |
| Bluetooth wireless card<br><i>i</i> <b>NOTE:</b> The functionality of the Bluetooth wireless card may vary based on the operating system. | Bluetooth 5.3  |

## Audio

The following table lists the audio specifications of your Dell Pro 14 Essential PV14250.

**Table 10. Audio specifications**

| Description                | Values   |                 |
|----------------------------|--|-----------------|
| Audio controller           | Realtek ALC3254  |                 |
| Stereo conversion          | Supported  |                 |
| Internal audio interface   | High definition audio  |                 |
| External audio interface   | One Universal audio jack   |                 |
| Number of speakers         | Two  |                 |
| Internal-speaker amplifier | Supported (Audio codec integrated)   |                 |
| External volume controls   | Keyboard shortcut controls   |                 |
| Speaker output:            |  |                 |
|                            | Average  | 2 W x 2 = 4 W   |
|                            | Peak   | 2.5 W x 2 = 5 W |
| Microphone                 | <ul style="list-style-type: none"> <li>Plastic chassis: Single integrated microphone/Digital-array microphones</li> <li>Aluminum chassis: Digital-array microphones</li> </ul> |                 |

## Storage

This section lists the storage options on your Dell Pro 14 Essential PV14250.

Your Dell Pro 14 Essential PV14250 supports the following storage configuration:

- One M.2 2230 solid state drive

The primary drive of your, Dell Pro 14 Essential PV14250 varies with the storage configuration. For computers with a M.2 drive, the M.2 drive is the primary drive

**Table 11. Storage specifications**

| Storage type               | Interface type     | Capacity   |
|----------------------------|--------------------|------------|
| M.2 2230 solid state drive | PCIe Gen 4 x4 NVMe | Up to 1 TB |

## Media-card reader

The following table provides the specification of media cards that are supported by your Dell Pro 14 Essential PV14250.

**Table 12. Media-card reader specifications**

| Description   | Values  |
|---|---|
| Media-card slot type  | One SD-card slot  |
| Media-cards supported   | <ul style="list-style-type: none"> <li>Secure Digital (SD)</li> <li>Secure Digital High Capacity (SDHC)</li> <li>Secure Digital Extended Capacity (SDXC)</li> </ul> |
| <p><b>NOTE:</b> The maximum capacity of the media-card reader varies depending on the standard of the media card that is inserted in your computer.</p> |   |

## Keyboard

The following table lists the keyboard specifications of your Dell Pro 14 Essential PV14250.

**Table 13. Keyboard specifications**

| Description        | Values  |
|--------------------|---|
| Keyboard type      | <ul style="list-style-type: none"> <li>Standard Copilot key backlit keyboard</li> <li>Standard Copilot key non-backlit keyboard</li> </ul>  |
| Keyboard layout    | QWERTY  |
| Number of keys     | <ul style="list-style-type: none"> <li>United States and Canada: 79 keys</li> <li>United Kingdom: 80 keys</li> <li>Japan: 83 keys</li> <li>Brazil: 81 keys</li> </ul>   |
| Key pitch          | <p>X=19.05mm key pitch</p> <p>Y=18.05mm key pitch</p>   |
| Keyboard shortcuts | <p>Some keys on your keyboard have two symbols on them. These keys can be used to type alternate characters or to perform secondary functions. To type the alternate character, press Shift and the desired key. To perform secondary functions, press Fn and the desired key.</p> <p><b>NOTE:</b> You can define the primary behavior of the function keys (F1–F12) changing <b>Function Key Behavior</b> in BIOS setup program.</p> |

## Keyboard shortcuts

**NOTE:** Keyboard characters may differ depending on the keyboard language configuration. Keys that are used for shortcuts remain the same across all language configurations.

Some keys on your keyboard have two symbols on them. These keys can be used to type alternate characters or to perform secondary functions. The symbol that is shown on the lower part of the key refers to the character that is typed out when the key is pressed. If you press shift and the key, the symbol that is shown on the upper part of the key is typed out. For example, if you press **2**, 2 is typed out; if you press **shift + 2**, @ is typed out.

The keys F1-F12 at the top row of the keyboard perform specific functions, as indicated by the icon on the key. Press the function key to enable the task represented by the icon. For example, pressing F1 mutes the audio (see the table below).

However, if the function keys F1-F12 are needed for specific software applications, multimedia functionality can be disabled by pressing **fn + esc**. Later, multimedia control can be enabled by pressing **fn** and the respective function key. For example, mute audio by pressing **fn + F1**.

**i** **NOTE:** You can also define the primary behavior of the function keys (F1–F12) by changing **Function Key Behavior** in the BIOS setup program.

**Table 14. Function key primary behavior**

| Function key | Primary behavior           |
|--------------|----------------------------|
| F1           | Mute or unmute audio       |
| F2           | Decrease volume            |
| F3           | Increase volume            |
| F4           | Microphone Mute            |
| F5           | KB Illumination/Backlight  |
| F6           | Decrease brightness        |
| F7           | Increase brightness        |
| F8           | Switch to external display |
| F9           | Stealth mode               |
| F10          | Print screen               |
| F11          | Home                       |
| F12          | End                        |

The **Fn** key is also used with selected keys on the keyboard to invoke different functions.

**Table 15. Secondary behavior**

| Function key                 | Secondary behavior   |
|------------------------------|--|
| Fn + <b>F1</b> to <b>F12</b> | Operating system or application-specific behavior  |
| Fn + Ctrl                    | Open the application menu  |
| Fn + Esc                     | Toggle between multimedia and function key behavior  |
| Fn + PgUp                    | Scroll up the document or page   |
| Fn + PgDn                    | Scroll down the document or page   |
| Fn + Home                    | Move to the beginning of the document  |
| Fn + End                     | Move to the end of the document  |
| Copilot                      | <p>Launch Copilot in Windows</p> <p><b>i</b> <b>NOTE:</b> If Copilot in Windows is not available on your computer, the Copilot key launches Recall. If both Recall and Copilot in Windows are not available on your computer, the Copilot key launches Windows Search. For more information about Copilot in Windows and Recall, search in the Knowledge Base Resource at the <a href="#">Dell Support Site</a>.</p> |

# Camera

The following table lists the camera specifications of your Dell Pro 14 Essential PV14250.

**Table 16. Camera specifications**

| Description        |             | Values                      |
|--------------------|-------------|-----------------------------|
| Number of cameras  |             | One                         |
| Camera type        |             | FHD RGB                     |
| Camera location    |             | Front                       |
| Camera sensor type |             | CMOS sensor technology      |
| Camera resolution: |             |                             |
|                    | Still image | 2.07 megapixel              |
|                    | Video       | 1920 x 1080 (FHD) at 30 fps |

# Touchpad

The following table lists the touchpad specifications of your Dell Pro 14 Essential PV14250.

**Table 17. Touchpad specifications**

| Description          |            | Values   |
|----------------------|------------|--|
| Touchpad resolution: |            | >300 dpi   |
| Touchpad dimensions: |            |  |
|                      | Horizontal | 115 mm (4.52 in.)  |
|                      | Vertical   | 80 mm (3.14 in.)   |
| Touchpad gestures    |            | For more information about the touchpad gestures available on Windows, search <a href="#">Microsoft Support Site</a> . |

# Battery

The following table lists the battery specifications of your Dell Pro 14 Essential PV14250.

**Table 18. Battery specifications**

| Description              | Option one                               | Option two                               | Option three  |
|--------------------------|--|--|---|
| Battery type             | 4-cell lithium-ion, 54 Wh, ExpressCharge | 4-cell lithium-ion, 64 Wh, ExpressCharge | 3-cell lithium-ion, 41 Wh, ExpressCharge, ExpressCharge Boost |
| Battery voltage          | 15 VDC                                   | 15.20 VDC                                | 11.25 VDC   |
| Battery weight (minimum) | 0.23 Kg (0.52 lb)                        | 0.26 Kg (0.57 lb)                        | 0.18 Kg (0.39 lb)   |
| Battery dimensions:      |  |  |   |
|                          | Height                                   | 5.75mm (0.23 in.)                        | 5.75 mm (0.23 in.)  |

**Table 18. Battery specifications (continued)**

| Description  |           | Option one  | Option two  | Option three  |
|--|-----------|---|---|---|
|  | Width     | 271.90 mm (10.70 in.)   | 271.90 mm (10.70 in.)   | 206.40 mm (8.13 in.)  |
|  | Depth     | 82.00 mm (3.23 in.)   | 82.00 mm (3.23 in.)   | 82.00 mm (3.23 in.)   |
| Temperature range:   |           |   |   |   |
|  | Operating | <ul style="list-style-type: none"> <li>Charge: 0°C to 45°C (32°F to 113°F)</li> <li>Discharge: 0°C to 70°C (32°F to 158°F)</li> </ul> | <ul style="list-style-type: none"> <li>Charge: 0°C to 45°C (32°F to 113°F)</li> <li>Discharge: 0°C to 70°C (32°F to 158°F)</li> </ul> | <ul style="list-style-type: none"> <li>Charge: 0°C to 45°C (32°F to 113°F)</li> <li>Discharge: 0°C to 70°C (32°F to 158°F)</li> </ul> |
|  | Storage   | -20°C to 60°C (-4°F to 140°F)   | -20°C to 60°C (-4°F to 140°F)   | -20°C to 60°C (-4°F to 140°F)   |
| Battery operating time   |           | Varies depending on operating conditions and can significantly reduce under certain power-intensive conditions.                       | Varies depending on operating conditions and can significantly reduce under certain power-intensive conditions.                       | Varies depending on operating conditions and can significantly reduce under certain power-intensive conditions.                       |
| Battery charging time (approximate)<br>ⓘ <b>NOTE:</b> Control the charging time, duration, start and end time, and so on using the Dell Power Manager application. For more information about Dell Power Manager, search in the Knowledge Base Resource at <a href="#">Dell Support Site</a> .   |           | 3 hours (when the computer is off)  | 3 hours (when the computer is off)  | 3 hours (when the computer is off)  |
| Coin-cell battery  |           | CR2032  | CR2032  | CR2032  |
| <p>⚠ <b>CAUTION:</b> Operating and storage temperature ranges may differ among components, so operating or storing the device outside these ranges may impact the performance of specific components.</p> <p>⚠ <b>CAUTION:</b> Dell recommends that you charge the battery regularly for optimal power consumption. If your battery charge is completely depleted, connect the power adapter, turn on your computer, and then restart your computer to reduce the power consumption.</p> |           |   |   |   |

## Power requirements

ⓘ **NOTE:** The information in this section is applicable to the European Union (EU) countries.

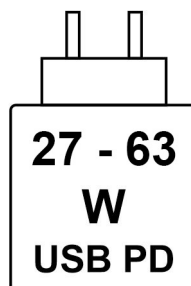

**Figure 8. Power requirements for computers shipped with a 4-cell, 64 Wh battery**

The power that is delivered by the charger must be between a minimum of 27 Watts that is required by the radio equipment, and a maximum of 63 Watts in order to achieve the maximum charging speed.

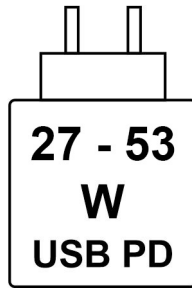

**Figure 9. Power requirements for computers shipped with a 4-cell, 54 Wh battery**

The power that is delivered by the charger must be between a minimum of 27 Watts that is required by the radio equipment, and a maximum of 53 Watts in order to achieve the maximum charging speed.

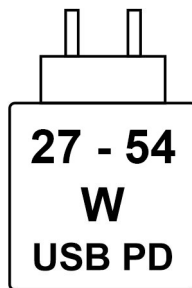

**Figure 10. Power requirements for computers shipped with a 3-cell, 41 Wh battery**

The power that is delivered by the charger must be between a minimum of 27 Watts that is required by the radio equipment, and a maximum of 54 Watts in order to achieve the maximum charging speed.

This computer supports USB Power Delivery (PD) fast charging.

## Power adapter

The following table lists the power adapter specifications of your Dell Pro 14 Essential PV14250.

**Table 19. Power-adapter specifications**

| Description                 |        | Values                         |
|-----------------------------|--------|--------------------------------|
| Type                        |        | 65 W AC adapter, 4.5 mm barrel |
| Power-adapter dimensions:   |        |                                |
|                             | Height | 29.50 mm (1.16 in.)            |
|                             | Width  | 47.00 mm (1.85 in.)            |
|                             | Depth  | 108.00 mm (4.25 in.)           |
| Input voltage               |        | 100 VAC–240 VAC                |
| Input frequency             |        | 50 Hz-60 Hz                    |
| Input current (maximum)     |        | 1.60 A/1.70 A                  |
| Output current (continuous) |        | 3.34 A                         |

**Table 19. Power-adapter specifications (continued)**



| Description  |           | Values                         |
|--|-----------|--------------------------------|
| Rated output voltage   |           | 19.50 V                        |
| Temperature range:   |           |                                |
|  | Operating | 0°C to 40°C (32°F to 104°F)    |
|  | Storage   | -40°C to 70°C (-40°F to 158°F) |
|  <b>CAUTION:</b> Operating and storage temperature ranges may differ among components, so operating or storing the device outside these ranges may impact the performance of specific components. |           |                                |

## Power adapter requirements of Dell Pro 14 Essential PV14250

 **NOTE:** If you did not purchase the Dell-branded power adapter that is recommended for your computer, ensure that the power adapter you use meets the following requirements.

The following table lists the power adapter requirements for your Dell Pro 14 Essential PV14250.

**Table 20. Power adapter requirements**

| Description  | Value   |
|--|---|
| Power that is required from a power adapter to achieve optimal performance   | 65 W  |
| Power that charges the computer at a slower speed<br> <b>NOTE:</b> A warning message may appear informing you about the use of a lower-powered adapter and slower charging speed.   | Less than 60 W  |
| Minimum power that is required from a power adapter to operate the computer and charge the battery<br> <b>NOTE:</b> A warning message appears informing you about the use of a lower-powered adapter and slower charging speed. | 27 W  |
| USB Power Delivery (PD) fast charging  | Supported   |
| ExpressCharge mode   | Supported<br> <b>NOTE:</b> Ensure that the computer is connected to a 65 W power adapter for this feature to be supported. |

## Display

The following table lists the display specifications of your Dell Pro 14 Essential PV14250.

**Table 21. Display specifications**

| Description              | Option one   | Option two   |
|--------------------------|--|--|
| Display type             | Laptop 35.5 cm (14") Full High Definition Plus (FHD+), ComfortView | Laptop 35.5 cm (14") 2.5k, ComfortView                 |
| Touch options            | Not supported  | Not supported  |
| Display-panel technology | In-Plane Switching (IPS) with Wide-viewing Angle (WVA)             | In-Plane Switching (IPS) with Wide-viewing Angle (WVA) |



**Table 21. Display specifications (continued)**

| Description                             | Option one   | Option two   |
|---|--|--|
| Display-panel dimensions (active area): |  |  |
| Height                                  | 301.59 mm (11.87 in.)  | 301.59 mm (11.87 in.)  |
| Width                                   | 188.50 mm (7.42 in.)   | 188.50 mm (7.42 in.)   |
| Diagonal                                | 355.65 mm (14 in.)   | 355.65 mm (14 in.)   |
| Display-panel native resolution         | 1920 x 1200  | 2560 x 1600  |
| Luminance (typical)                     | 300 nits   | 300 nits   |
| Megapixels                              | 2.3  | 4.09   |
| Color gamut                             | 45% NTSC   | 100% sRGB  |
| Pixels Per Inch (PPI)                   | 162  | 216  |
| Contrast ratio (minimum)                | 800:1  | 800:1  |
| Response time (maximum)                 | 35 ms  | 35 ms  |
| Refresh rate                            | 48 Hz/60 Hz  | 48 Hz/120 Hz   |
| Horizontal view angle                   | <ul style="list-style-type: none"> <li>Minimum: 80 +/- degrees</li> <li>Typical: 85 +/- degrees</li> </ul> | <ul style="list-style-type: none"> <li>Minimum: 80 +/- degrees</li> <li>Typical: 85 +/- degrees</li> </ul> |
| Vertical view angle                     | <ul style="list-style-type: none"> <li>Minimum: 80 +/- degrees</li> <li>Typical: 85 +/- degrees</li> </ul> | <ul style="list-style-type: none"> <li>Minimum: 80 +/- degrees</li> <li>Typical: 85 +/- degrees</li> </ul> |
| Pixel pitch                             | 0.157 x 0.157 mm   | 0.1178 x 0.1178 mm   |
| Power consumption (maximum)             | 3.68 W without touch @Mosaic   | 4.8 W @mosaic pattern 120 Hz   |
| Anti-glare vs glossy finish             | Anti-Glare   | Anti-Glare   |

## Fingerprint reader (optional)

The following table lists the specifications of the optional fingerprint-reader of your Dell Pro 14 Essential PV14250.

**Table 22. Fingerprint reader specifications**

| Description       | Values     |
|-------------------|------------|
| Sensor technology | Capacitive |
| Sensor resolution | 500 ppi    |
| Sensor pixel size | 108 x 88   |

# Sensors

The following table lists the sensors of your Dell Pro 14 Essential PV14250.

**Table 23. Sensor**

| Sensor support |
|----------------|
| Hall sensor    |

# GPU—Integrated

The following table lists the specifications of the integrated Graphics Processing Unit (GPU) supported by your Dell Pro 14 Essential PV14250.

**Table 24. GPU—Integrated**

| Controller  | Memory size   | Processor  |
|---|---|--|
| <ul style="list-style-type: none"><li>Intel UHD Graphics</li><li>Intel Iris Xe Graphics</li></ul> | <ul style="list-style-type: none"><li>Shared system memory</li><li>Shared system memory</li></ul> | <ul style="list-style-type: none"><li>13th Generation Intel Core 3/5/7</li></ul> |

# External display support

The following table lists the external display support for your Dell Pro 14 Essential PV14250.

**Table 25. External display support**

| Graphics card   | Supported external displays with laptop display enabled | Supported external displays with laptop display disabled |
|---|---|--|
| iGPU only   | 3   | 4  |
|  <b>NOTE:</b> For more information about external display support, see the <i>External Display Connection Guide</i> on <a href="#">Dell Support Site</a> . |   |  |

# Hardware security

The following table lists the hardware security of your Dell Pro 14 Essential PV14250.

**Table 26. Hardware security**

| Hardware security                          |
|--|
| Wedge-shaped lock slot                     |
| Trusted Platform Module (TPM) 2.0 security |

# Operating and storage environment

This table lists the operating and storage specifications of your Dell Pro 14 Essential PV14250.

**Airborne contaminant level:** G1 as defined by ISA-S71.04-1985

**Table 27. Computer environment**

| Description  | Operating                   | Storage                        |
|--|-----------------------------|--------------------------------|
| Temperature range  | 0°C to 40°C (32°F to 104°F) | -40°C to 65°C (-40°F to 149°F) |
| Relative humidity (maximum)  | 90% (non-condensing)        | 95% (non-condensing)           |
| Vibration (maximum)*   | 0.66 GRMS                   | Not applicable                 |
| Shock (maximum)  | 140 G†                      | Not applicable                 |
| Altitude range   | Not applicable              | Not applicable                 |
| <b>⚠ CAUTION: Operating and storage temperature ranges may differ among components, so operating or storing the device outside these ranges may impact the performance of specific components.</b> |                             |                                |

\* Measured using a random vibration spectrum that simulates the user environment.

† Measured using a 2 ms half-sine pulse.

## Dell support policy

For information about Dell support policy, search [Dell Support Site](#).

## Dell low blue light display

**⚠ WARNING: Prolonged exposure to blue light from the display may lead to long-term effects such as eye strain, eye fatigue, or damage to the eyes.**

Blue light is a color in the light spectrum which has a short wavelength and high energy. Chronic exposure to blue light, particularly from digital sources may disrupt sleep patterns and cause long-term effects such as eye strain, eye fatigue, or damage to the eyes.

The display on this computer is designed to minimize blue light and complies with TÜV Rheinland's requirement for low blue light displays.

Low blue light mode is enabled at the factory, so no further configuration is necessary.

To reduce the risk of eye strain, it is also recommended that you:

- Position the display at a comfortable viewing distance between 20 and 28 inches (50 cm and 70 cm) from your eyes.
- Blink frequently to moisten your eyes, wet your eyes with water, or apply suitable eye drops.
- Take an extended break for 20 minutes every two hours.
- Look away from your display, and gaze at a distant object at 20 ft (609.60 cm) away for at least 20 seconds during each break.

## ComfortView Plus

**⚠ WARNING: Prolonged exposure to blue light from the display may lead to long-term effects such as eye strain, eye fatigue, or damage to the eyes.**

Blue light is a color in the light spectrum which has a short wavelength and high energy. Chronic exposure to blue light, particularly from digital sources may disrupt sleep patterns and cause long-term effects such as eye strain, eye fatigue, or damage to the eyes.

The display on this computer is designed to minimize blue light and complies with TÜV Rheinland's requirement for low blue light displays.

Low blue light mode is enabled at the factory, so no further configuration is necessary.









To reduce the risk of eye strain, it is also recommended that you:

- Position the display at a comfortable viewing distance between 20 and 28 inches (50 cm and 70 cm) from your eyes.
- Blink frequently to moisten your eyes, wet your eyes with water, or apply suitable eye drops.
- Take an extended break for 20 minutes every two hours.
- Look away from your display, and gaze at a distant object at 20 ft (609.60 cm) away for at least 20 seconds during each break.

# Working inside your computer

## Safety instructions

Use the following safety guidelines to protect your computer from potential damage and to ensure your personal safety. Unless otherwise noted, each procedure in this document assumes that you have read the safety information that shipped with your computer.



-  **WARNING:** Before working inside your computer, read the safety information that is shipped with your computer. For more safety best practices, see [Dell Regulatory Compliance Home Page](#).
-  **WARNING:** Disconnect your computer from all power sources before opening the computer cover or panels. After you finish working inside the computer, replace all covers, panels, and screws before connecting your computer to an electrical outlet.
-  **WARNING:** For laptops, discharge the battery completely before removing it. Disconnect the AC power adapter from the computer and operate the computer solely on battery power—the battery is fully discharged when the computer no longer turns on when the power button is pressed.
-  **CAUTION:** To avoid damaging the computer, ensure that the work surface is flat, dry, and clean.
-  **CAUTION:** You should only perform troubleshooting and repairs as authorized or directed by the Dell technical support team. Damage due to servicing that is not authorized by Dell is not covered by your warranty.
-  **CAUTION:** Before touching anything inside your computer, ground yourself by touching an unpainted metal surface, such as the metal at the back of the computer. While you work, periodically touch an unpainted metal surface to dissipate static electricity which could harm internal components.
-  **CAUTION:** To avoid damaging the components and cards, handle them by their edges, and avoid touching the pins and the contacts.
-  **CAUTION:** When you disconnect a cable, pull it by its connector or its pull tab, not the cable itself. Some cables have connectors with locking tabs or thumbscrews that you must disengage before disconnecting the cable. When disconnecting cables, keep them evenly aligned to avoid bending the connector pins. When connecting cables, ensure that the connector on the cable is correctly oriented and aligned with the port.
-  **CAUTION:** Press and eject any installed card from the media-card reader.

## Before working inside your computer

### About this task

 **NOTE:** The images in this document may differ from your computer depending on the configuration you ordered.

### Steps

1. Save and close all open files and exit all open applications.
2. Shut down your computer. For Windows operating system, click **Start** >  **Power** > **Shut down**.  
 **NOTE:** If you are using a different operating system, see the documentation of your operating system for instructions.
3. Turn off all the attached peripherals.
4. Disconnect your computer from the electrical outlet.

5. Disconnect all attached network devices and peripherals, such as keyboard, mouse, and monitor from your computer.
6. Remove any media card and optical drive from your computer, if applicable.
7. To clean the air vents, use a soft brush and move vertically.

 **NOTE:** Do not remove the base cover or use any blower to clean the vents.

8. Enter the Service Mode.

### Service Mode

Service Mode is used to cut off power without disconnecting the battery cable from the system board before conducting repairs in the computer.

 **CAUTION:** If you are unable to turn on the computer to put it into Service Mode, disconnect the battery cable. To disconnect the battery cable, follow the steps in [Removing the battery](#).

 **NOTE:** Ensure that your computer is shut down and the power adapter is disconnected.

- a. Press and hold the B key and the power button for 3 seconds, or until the Dell logo appears on the screen.
- b. If the **Owner Tag** is set, it is displayed on the screen. Press any key to continue.

 **NOTE:** If the **Owner Tag** information is not already set, the computer automatically skips this step and proceeds to enter Service Mode.

- c. If the power adapter is still connected, a message appears on the screen prompting you to disconnect it. Disconnect the power adapter, then press any key to continue.
- d. When the **System Ready For Service** message appears on the screen, press any key to proceed. The computer emits three short beeps and shuts down immediately. The computer shuts down and enters the Service Mode.

## Safety precautions

This section details the primary steps to be followed before disassembling any device or component.

Observe the following safety precautions before any installation or break-fix procedures involving disassembly or reassembly:

- Turn off the computer and all attached peripherals.
- Disconnect the computer from AC power.
- Disconnect all network cables and peripherals from the computer.
- Use an ESD field service kit when working inside your computer to avoid electrostatic discharge (ESD) damage.
- Place the removed component on an anti-static mat after removing it from the computer.
- Press and hold the power button for 15 seconds to discharge the residual power in the system board.

## Bonding

Bonding is a method for connecting two or more grounding conductors to the same electrical potential. This is done by using a field service electrostatic discharge (ESD) kit. When connecting a bonding wire, ensure that it is connected to bare metal and never to a painted or nonmetal surface. Ensure that the wrist strap is secure and in full contact with your skin. Remove all jewelry, watches, bracelets, or rings before grounding yourself and the equipment.

## Electrostatic discharge—ESD protection

ESD is a major concern when you handle electronic components, especially sensitive components such as expansion cards, processors, memory modules, and system boards. A slight charge can damage circuits in ways that may not be obvious, such as intermittent problems or a shortened product life span. As the industry pushes for lower power requirements and increased density, ESD protection is an increasing concern.

Two recognized types of ESD damage are catastrophic and intermittent failures.

- **Catastrophic** – Catastrophic failures represent approximately 20 percent of ESD-related failures. The damage causes an immediate and complete loss of device functionality. An example of catastrophic failure is a memory module that has received a static shock and immediately generates a "No POST/No Video" symptom with a beep code that is emitted for missing or nonfunctional memory.

- **Intermittent** – Intermittent failures represent approximately 80 percent of ESD-related failures. The high rate of intermittent failures means that most of the time when damage occurs, it is not immediately recognizable. The memory module receives a static shock, but the tracing is merely weakened and does not immediately produce outward symptoms that are related to the damage. The weakened trace may take weeks or months to melt, and in the meantime may cause degradation of memory integrity, intermittent memory errors, and so on.

Intermittent failures that are also called latent or "walking wounded" are difficult to detect and troubleshoot.

Perform the following steps to prevent ESD damage:

- Use a wired ESD wrist strap that is properly grounded. Wireless anti-static straps do not provide adequate protection. Touching the chassis before handling parts does not ensure adequate ESD protection on parts with increased sensitivity to ESD damage.
- Handle all static-sensitive components in a static-safe area. If possible, use anti-static floor pads and workbench pads.
- When unpacking a static-sensitive component from its shipping carton, do not remove the component from the anti-static packing material until you are ready to install the component. Before unwrapping the anti-static packaging, use the anti-static wrist strap to discharge the static electricity from your body.

**i** **NOTE:** You can protect against ESD and discharge static electricity from your body by touching a metal-grounded object before you interact with anything electronic, for example, an unpainted metal surface on your computer's I/O panel. When connecting a peripheral (including handheld digital assistants) to your computer, you should always ground both yourself and the peripheral before connecting it to the computer. In addition, as you work inside the computer, periodically touch a metal-grounded object to remove any static charge that your body may have accumulated.

For more information about the wrist strap and ESD wrist strap tester, see [Components of an ESD Field Service Kit](#).

- Before transporting a static-sensitive component, place it in an anti-static container or packaging.

## ESD Field Service kit

The unmonitored field service kit is the most commonly used service kit. Each Field Service kit includes three main components: anti-static mat, wrist strap, and bonding wire.

**⚠ CAUTION:** It is critical to keep ESD-sensitive devices away from internal parts that are insulated and often highly charged, such as plastic heat sink casings.

## Working environment

Before the ESD Field Service kit is deployed, conduct an evaluation of the site to ensure proper setup and readiness. For example, deploying the kit for a server environment is different than for a desktop or laptop environment. Servers are typically installed in a rack within a data center; desktops or laptops are typically placed on office desks or cubicles. Always look for a large open flat work area that is free of clutter and large enough to deploy the ESD kit with additional space to accommodate the type of computer that is being repaired. The workspace should also be free of insulators that can cause an ESD event. On the work area, insulators such as styrofoam and other plastics should always be moved at least 12 inches or 30 centimeters away from sensitive parts before physically handling any hardware components.

## ESD packaging

All ESD-sensitive devices must be shipped and received in static-safe packaging. Metal, static-shielded bags are preferred. However, you should always return the damaged component using the same ESD bag and packaging that the new part arrived in. The ESD bag should be folded over and taped shut and all the same foam packing material should be used in the original box that the new part arrived in. ESD-sensitive devices should be removed from packaging only at an ESD-protected work surface, and parts should never be placed on top of the ESD bag because only the inside of the bag is shielded. Always place parts in your hand, on the anti-static mat, in the computer, or inside an ESD bag.

## Components of an ESD Field Service kit

The components of an ESD Field Service kit are:

- **Anti-Static Mat** – The anti-static mat is dissipative and parts can be placed on it during service procedures. When using an anti-static mat, your wrist strap should be snug and the bonding wire should be connected to the anti-static mat and to any bare metal on the computer being worked on. Once deployed properly, service parts can be removed from the ESD bag and

placed directly on the anti-static mat. ESD-sensitive items are safe in your hand, on the anti-static mat, in the computer, or inside an ESD bag.

- **Wrist Strap and Bonding Wire** – If an anti-static mat is not being used, the wrist strap and bonding wire should be connected directly between your wrist and an exposed metal part of the hardware. If you are using an anti-static mat, connect the wrist strap and bonding wire to the anti-static mat to ensure protection for any hardware placed on the mat. The physical connection of the wrist strap and bonding wire between your skin, the anti-static mat, and the hardware is known as bonding. Use only Field Service kits with a wrist strap, anti-static mat, and bonding wire. Never use wireless wrist straps. Always be cautious that the internal wires of a wrist strap are prone to damage from normal wear and tear, and must be checked regularly with a wrist strap tester in order to avoid accidental ESD hardware damage. It is recommended to test the wrist strap and bonding wire at least once per week.
- **ESD Wrist Strap Tester** – The wires inside an ESD strap are prone to damage over time. When using an unmonitored ESD kit, it is recommended to test the wrist strap regularly—ideally before each service session, and at a minimum, once per week. The most reliable method for testing is with a wrist strap tester. To perform the test, connect the bonding wire of the wrist strap to the tester while wearing the strap. Press the test button to initiate the check. A green LED indicates a successful test, while a red LED and audible alarm signal a failure.

**NOTE:** It is recommended to always use the traditional wired ESD grounding wrist strap and protective anti-static mat when servicing Dell products. In addition, it is critical to keep sensitive parts separate from all insulator parts while servicing the computer.

## Transporting sensitive components

When transporting ESD sensitive components such as replacement parts or parts to be returned to Dell, it is critical to place these parts in anti-static bags for safe transport.

## After working inside your computer

### About this task

**CAUTION:** Leaving stray or loose screws inside your computer may severely damage your computer.

### Steps

1. Replace all screws and ensure that no stray screws remain inside your computer.
2. Connect any external devices, peripherals, or cables you removed before working on your computer.
3. Replace any media cards, disks, or any other parts that you removed before working on your computer.
4. Connect your computer to their electrical outlets.

**NOTE:** To exit service mode, ensure to connect the AC adapter to the power-adapter port on your computer.

5. Press the power button to turn on the computer.

## BitLocker

When updating the BIOS on a computer with BitLocker enabled, consider the following precautions.

**CAUTION:** If BitLocker is not suspended before updating the BIOS, the BitLocker key will not be recognized the next time that you reboot the computer. You are prompted to enter the recovery key to progress, and the computer displays a prompt for the recovery key on each reboot. If the recovery key is not known, this can result in data loss or an operating system reinstall. For more information, see Knowledge Article: [updating the BIOS on Dell computers with BitLocker enabled](#).

The installation of the following components triggers BitLocker:

- Hard disk drive or solid state drive
- System board



## Recommended tools













The procedures in this document may require the following tools:

- Phillips screwdriver #0
- Phillips screwdriver #1
- Plastic scribe



















## Screw list

- NOTE:** When removing screws from a component, it is recommended to note the screw type and the quantity of screws, and then place them in a screw storage box. This is to ensure that the correct number of screws and correct screw type is restored when the component is replaced.
- NOTE:** Some computers have magnetic surfaces. Ensure that the screws are not left attached to such surfaces when replacing a component.
- NOTE:** Screw color may vary depending on the configuration ordered.



**Table 28. Screw list**

| Component   | Screw type    | Quantity | Screw image   |
|---|---------------|----------|---|
| Base cover for computers that are shipped with a plastic chassis.       | Captive Screw | 2        |    |
|   | M2x4          | 6        |  |
| Base cover for computers that are shipped with an aluminum chassis.     | Captive Screw | 2        |  |
|   | M2x4          | 5        |  |
| System board for computers that are shipped with a plastic chassis.     | M2x2          | 2        |  |
|   | M2.5x4        | 2        |  |
|   | M2x4          | 3        |  |
| System board for computers that are shipped with an aluminum chassis.   | M2x2          | 2        |  |
|   | M2.5x4        | 2        |  |
|   | M2x4          | 2        |  |
| Display hinges for computers that are shipped with a plastic chassis.   | M2.5x4        | 4        |  |
| Display hinges for computers that are shipped with an aluminum chassis. | M2.5x4.5      | 4        |  |

**Table 28. Screw list (continued)**

| Component   | Screw type | Quantity | Screw image   |
|---|------------|----------|---|
| 41 W battery  | M2x3       | 3        |    |
| 54 W battery  | M2x3       | 5        |    |
| Power-button board  | M2x3       | 1        |    |
| I/O board   | M2.5x4     | 2        |    |
|   | M2x3       | 2        |    |
| Wireless-card bracket   | M2x3       | 1        |    |
| Solid-state drive   | M2x3       | 1        |    |
|   | M2x1.8     | 1        |    |
| Power-adaptor port for computers that are shipped with a plastic chassis.   | M2.5x4     | 2        |    |
| Power-adaptor port for computers that are shipped with an aluminum chassis. | M2.5x4.5   | 2        |  |
| Heat sink for computers that are shipped with a plastic chassis.            | Captive    | 4        |  |
| Heat sink for computers that are shipped with an aluminum chassis.          | Captive    | 7        |  |
| Display assembly for computers that are shipped with a plastic chassis.     | M2.5x4     | 4        |  |
| Display assembly for computers that are shipped with an aluminum chassis.   | M2.5x4.5   | 4        |  |
| Display panel for computers that are shipped with a plastic chassis.        | M2.5x2.5   | 6        |  |
| System fan  | M2x4       | 2        |  |
| Touchpad for computers that are shipped with a plastic chassis.             | M2x1.8     | 2        |  |
|   | M1.6x2.5   | 4        |  |

**Table 28. Screw list (continued)**

| <b>Component</b>  | <b>Screw type</b> | <b>Quantity</b> | <b>Screw image</b>  |
|---|-------------------|-----------------|---|
| Touchpad for computers that are shipped with an aluminum chassis. | M2x2              | 4               |  |
|   | M2x2.5            | 1               |  |

## Major components of Dell Pro 14 Essential PV14250

The following image shows the major components of Dell Pro 14 Essential PV14250.



**Figure 11. Major components**

1. Base cover
2. Battery
3. Heat sink
4. Memory
5. System board
6. Speaker
7. Touchpad
8. Palm-rest and keyboard assembly
9. Display assembly
10. Power button
11. I/O board
12. Fan
13. Optical drive
14. SSD
15. Cable

- 12. Fan
- 13. Solid-state drive
- 14. Wireless card
- 15. Power adapter port

**NOTE:** Dell provides a list of components and their part numbers for the original computer configuration purchased. These parts are available according to warranty coverage purchased by the customer. Contact your Dell sales representative for purchase options.

## Customer Replaceable Units (CRUs) and Field Replaceable Units (FRUs) list

The replaceable components in your Dell Pro 14 Essential PV14250 are either Customer Replaceable Units (CRUs) or Field Replaceable Units (FRUs).

**CAUTION:** To avoid any potential damage to the component or loss of data, ensure that an authorized service technician replaces the Field Replaceable Units (FRUs). Customers can replace only the Customer Replaceable Units (CRUs) following the safety precautions and replacement procedures.

**Table 29. CRU and FRU list**

| Customer Replaceable Unit (CRU) | Field Replaceable Unit (FRU)  |
|---------------------------------|---|
| Base Cover                      | I/O board   |
| Battery                         | Heat sink   |
| Battery cable                   | Speakers  |
| Memory                          | Power button with fingerprint reader  |
| Solid-state drive               | Power-adapter port  |
| Wireless card                   | Display assembly  |
| System fan                      | Display bezel for computers that are shipped with a plastic chassis.                |
|                                 | Display panel for computers that are shipped with a plastic chassis.                |
|                                 | Display cable for computers that are shipped with a plastic chassis.                |
|                                 | Camera and microphone module for computers that are shipped with a plastic chassis. |
|                                 | Display back cover  |
|                                 | USB Type-C bracket  |
|                                 | System board  |
|                                 | Touchpad  |
|                                 | Palm-rest and keyboard assembly   |

## Base cover

# Removing the base cover for computers shipped with a plastic chassis

### Prerequisites

1. Follow the procedure in [Before working inside your computer](#).

 **NOTE:** Ensure that your computer is in Service Mode. For more information, see step 6 in, [Before working inside your computer](#).

### About this task

The following images indicate the location of the base cover and provide a visual representation of the removal procedure.

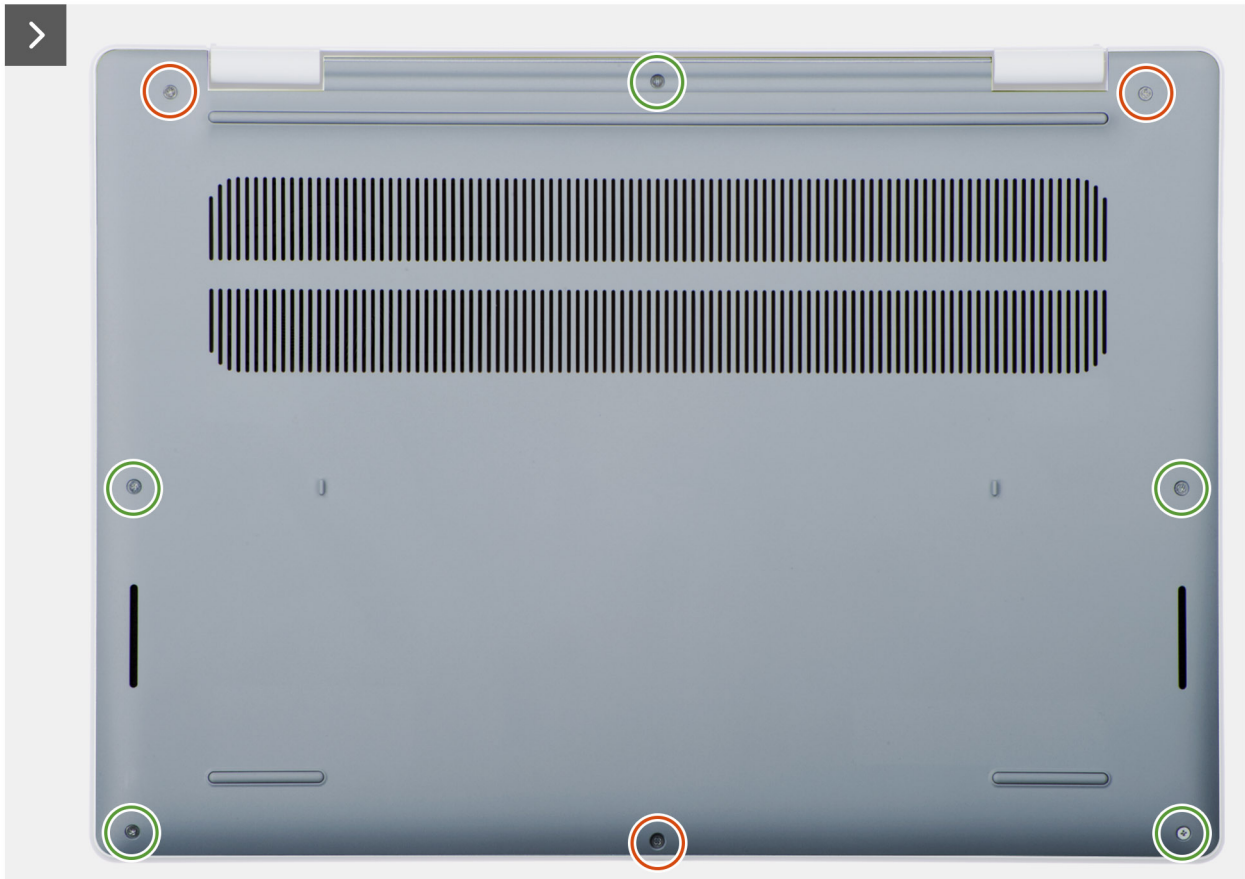
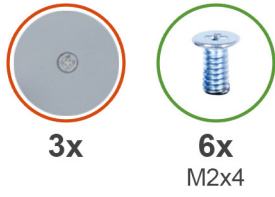

Figure 12. Removing the base cover

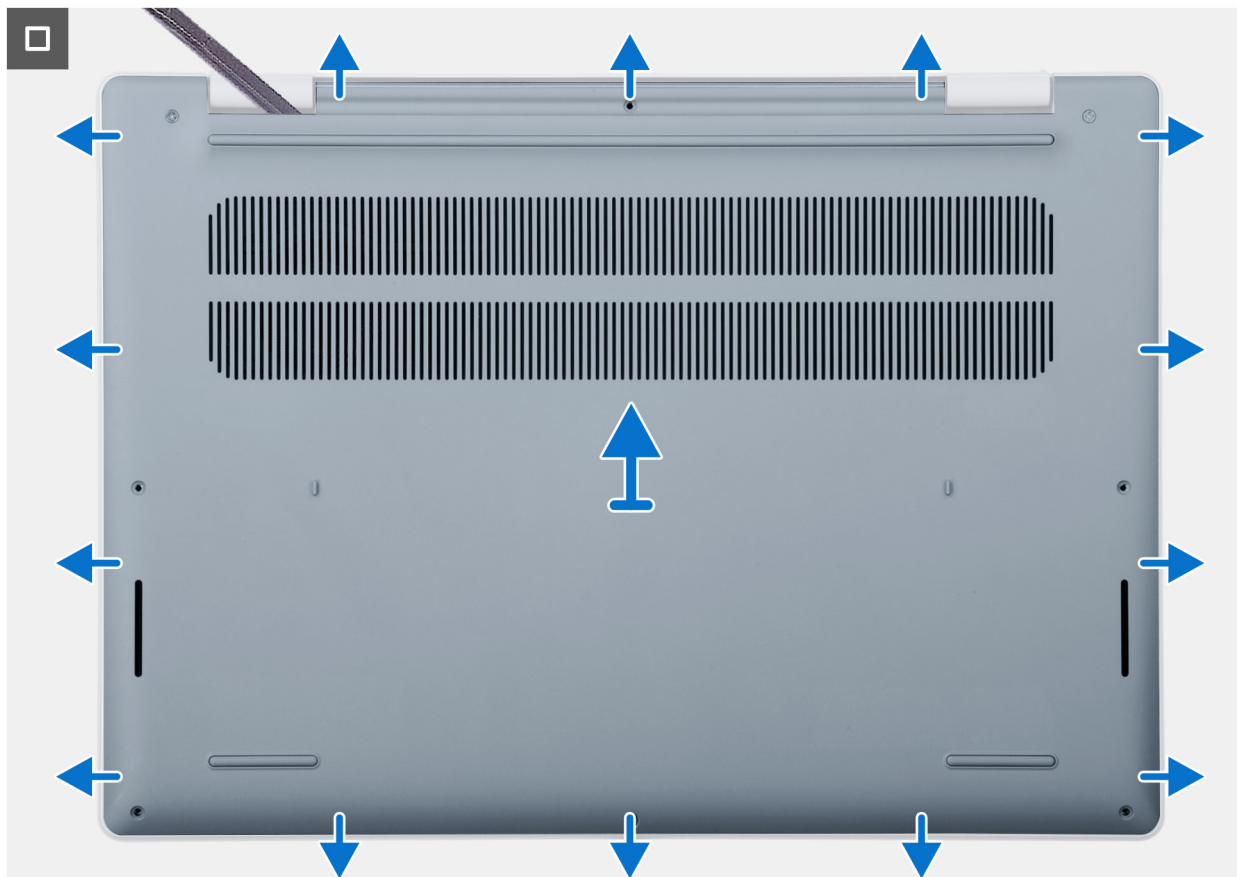

Figure 13. Removing the base cover

#### Steps

1. Remove the six screws (M2x4) that secure the base cover to the palm-rest and keyboard assembly.
2. Loosen the two captive screws that secure the base cover to the palm-rest and keyboard assembly.  
**NOTE:** Upon loosening the captive screws, the base cover opens up creating a gap between the base cover and the palm-rest assembly at the hinges.
3. Starting from the top-left corner of the hinge, pry the base cover to release the base cover from the palm-rest and keyboard assembly.
4. Lift the base cover off the palm-rest and keyboard assembly.

## Installing the base cover for computers shipped with a plastic chassis

#### Prerequisites

If you are replacing a component, remove the existing component before performing the installation procedure.

#### About this task

The following image indicates the location of the battery and provides a visual representation of the installation procedure.



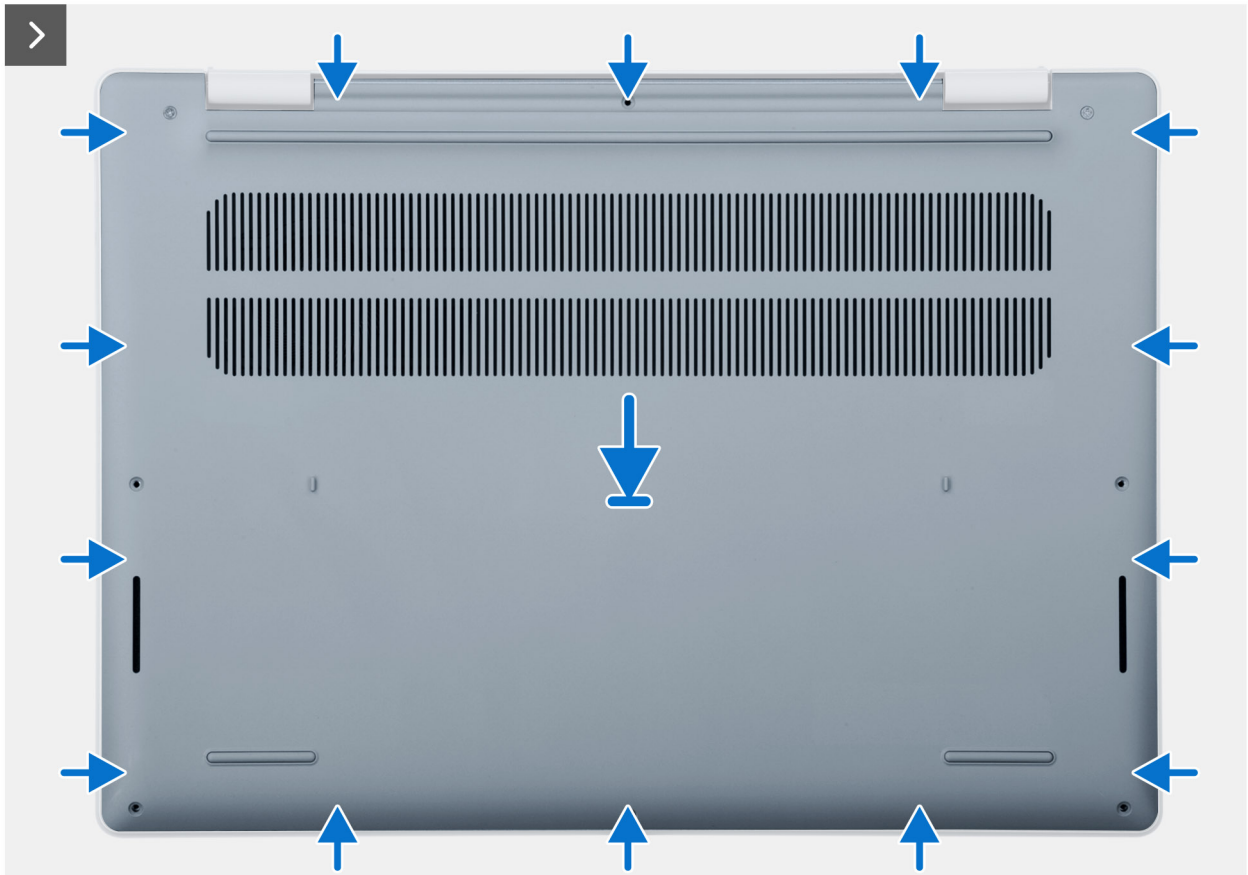
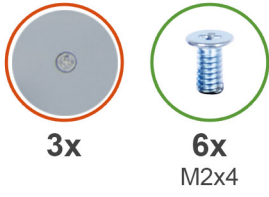

Figure 14. Installing base cover



**Figure 15. Installing the base cover**

#### Steps

1. Align the screw holes on the base cover with the screw holes on the palm-rest and keyboard assembly.
2. Snap the base cover into place.
3. Tighten the two captive screws that secure the base cover to the palm-rest and keyboard assembly.
4. Replace the six screws (M2x4) that secure the base cover to the palm-rest and keyboard assembly.

#### Next steps

1. Follow the procedure in [After working inside your computer](#).

## Removing the base cover for computers shipped with an aluminum chassis

#### Prerequisites

1. Follow the procedure in [Before working inside your computer](#).

**i** **NOTE:** Ensure that your computer is in Service Mode. For more information, see step 6 in, [Before working inside your computer](#).

#### About this task

The following images indicate the location of the base cover and provide a visual representation of the removal procedure.

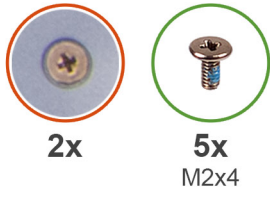

Figure 16. Removing the base cover

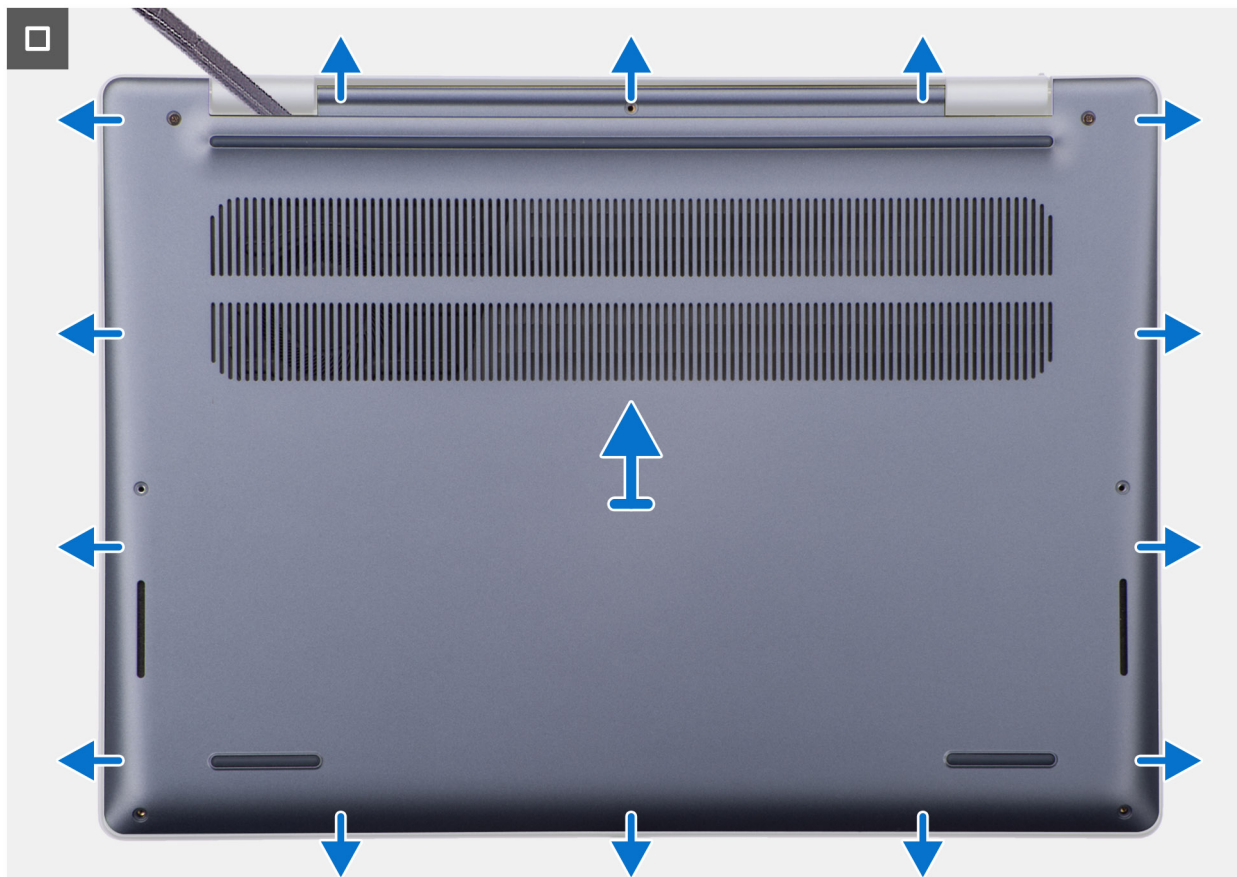

Figure 17. Removing the base cover

#### Steps

1. Loosen the two captive screws that secure the base cover to the palm-rest and keyboard assembly.  
**NOTE:** Upon loosening the captive screws, the base cover opens up creating a gap between the base cover and the palm-rest assembly at the hinges.
2. Remove the five screws (M2x4) that secure the base cover to the palm-rest and keyboard assembly.
3. Starting from the top-left corner of the hinge, pry the base cover to release the base cover from the palm-rest and keyboard assembly.
4. Lift the base cover off the palm-rest and keyboard assembly.

## Installing the base cover for computers shipped with an aluminum chassis

#### Prerequisites

If you are replacing a component, remove the existing component before performing the installation procedure.

#### About this task

The following image indicates the location of the base cover and provides a visual representation of the installation procedure.

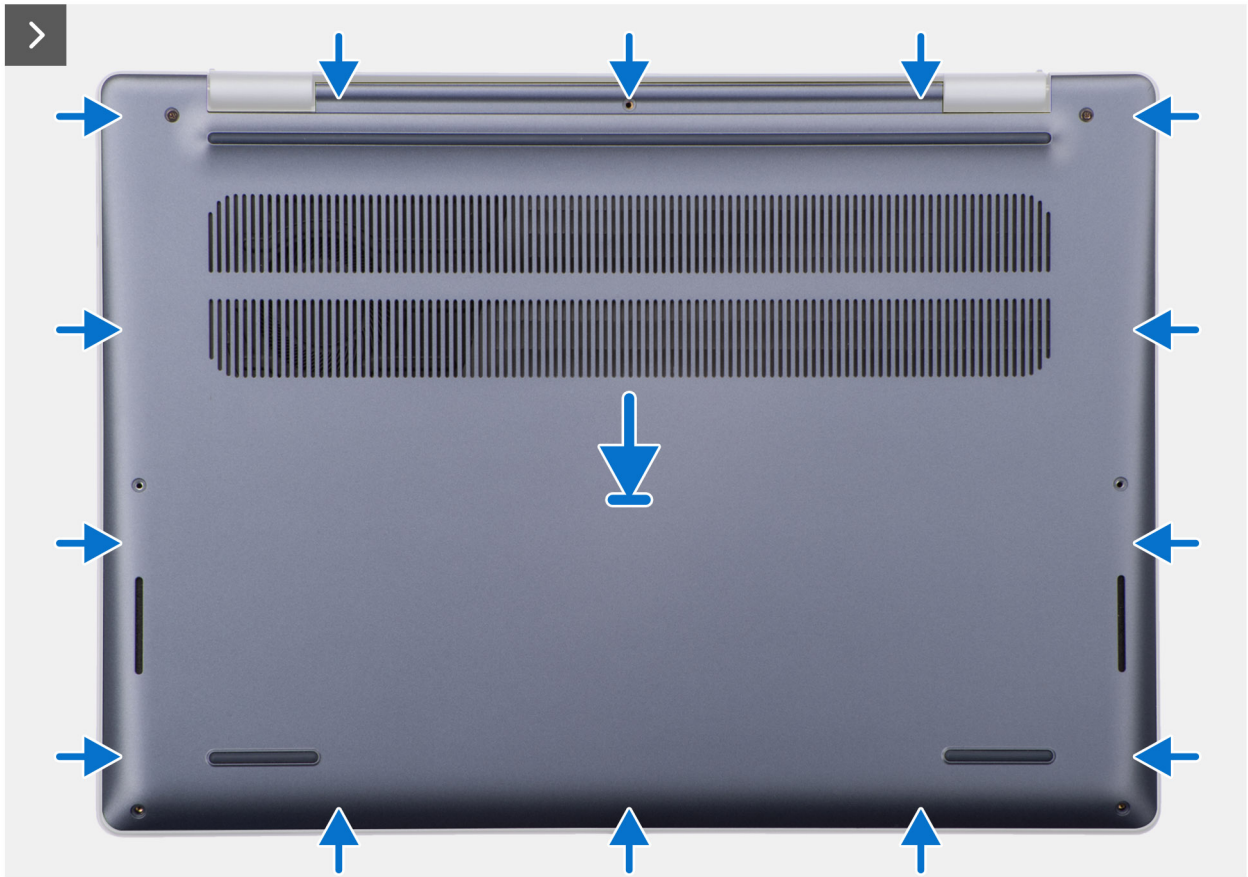
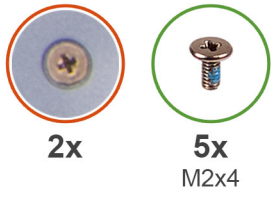

Figure 18. Installing the base cover



**Figure 19. Installing the base cover**

#### **Steps**

1. Align the screw holes on the base cover with the screw holes on the palm-rest and keyboard assembly.
2. Snap the base cover into place.
3. Tighten the two captive screws that secure the base cover to the palm-rest and keyboard assembly.
4. Replace the five screws (M2x4) that secure the base cover to the palm-rest and keyboard assembly.

#### **Next steps**

1. Follow the procedure in [After working inside your computer](#).

# Battery

## Rechargeable Li-ion battery precautions

### WARNING:

- Exercise caution when handling rechargeable Li-ion batteries.
- Discharge the battery completely before removing it. Disconnect the AC power adapter from the computer and operate the computer solely on battery power—the battery is fully discharged when the computer no longer turns on when the power button is pressed.
- Do not crush, drop, mutilate, or penetrate the battery with foreign objects.
- Do not expose the battery to high temperatures, or disassemble battery packs and cells.
- Do not apply pressure to the surface of the battery.
- Do not bend the battery.
- Do not use tools of any kind to pry on or against the battery.
- To prevent accidental puncture or damage to the battery and other components, ensure that no screws are lost or misplaced during the servicing of the computer.
- Always purchase genuine batteries from [Dell Site](#) or authorized Dell partners and resellers.
- Swollen batteries should not be used and should be replaced and disposed properly. For guidelines on how to handle and replace swollen rechargeable Li-ion batteries, see [Handling swollen rechargeable Li-ion batteries](#).

## Removing the 41 W battery for computers shipped with a plastic chassis

 CAUTION: The information in this removal section is intended for authorized service technicians only.

### Prerequisites

1. Follow the procedure in [Before working inside your computer](#).

 NOTE: Ensure that your computer is in Service Mode. For more information see, [Before working inside your computer](#).

2. Remove the [base cover for computers shipped with a plastic chassis](#).

### About this task

 CAUTION: Removing the battery resets the BIOS setup settings to default. It is recommended that you note the BIOS setup settings before removing the battery.

The following image indicates the location of the battery and provides a visual representation of the removal procedure.

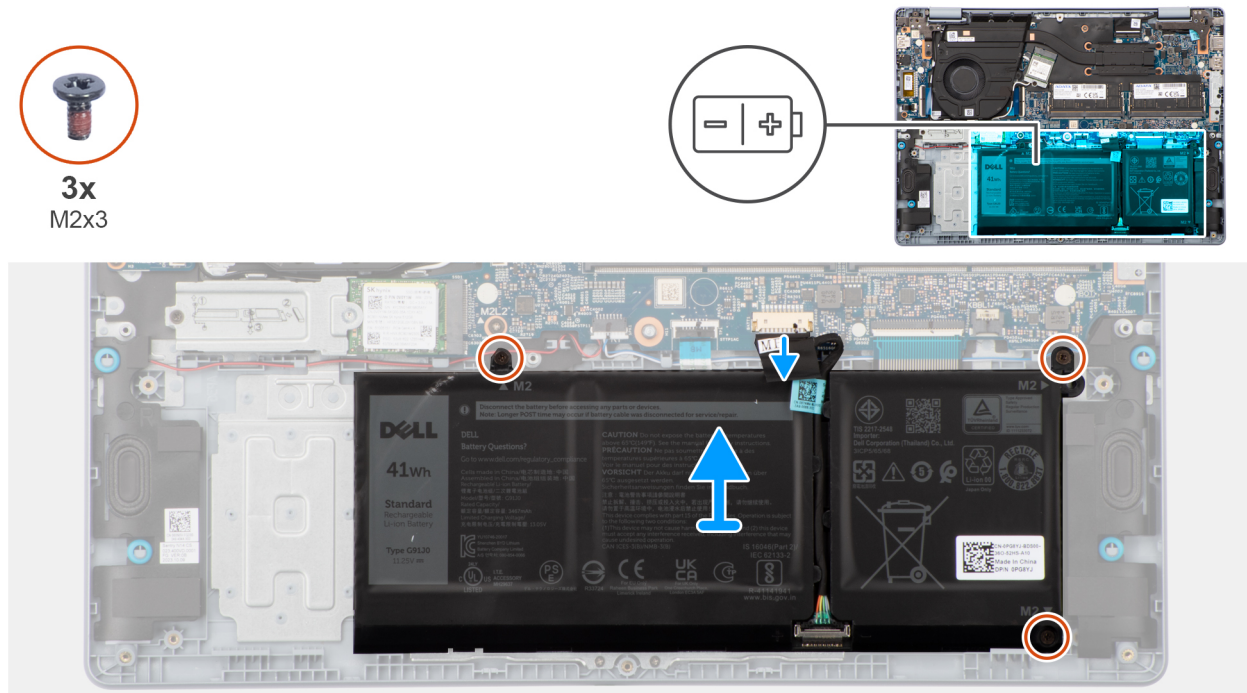

Figure 20. Removing the battery

#### Steps

1. Peel the adhesive tape that secures the battery cable to the system board.
2. Disconnect the battery cable from the connector (BATT1) on the system board.
3. Remove the three screws (M2x3) that secure the battery to the palm-rest and keyboard assembly.
4. Lift the battery off the palm-rest and keyboard assembly.

## Installing the 41 W battery for computers shipped with a plastic chassis

**CAUTION:** The information in this installation section is intended for authorized service technicians only.

#### Prerequisites

If you are replacing a component, remove the existing component before performing the installation process.

#### About this task

The following image indicates the location of the battery and provides a visual representation of the installation procedure.

Figure 21. Installing the battery





3x  
M2x3

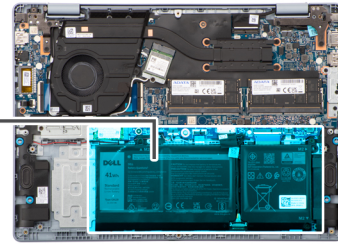
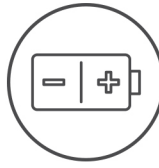

### Steps

1. Align the screw holes on the battery with the screw holes on the palm-rest and keyboard assembly.
2. Replace the three screws (M2x3) that secure the battery to the palm-rest and keyboard assembly.
3. Connect the battery cable to the connector (BATT1) on the system board.
4. Adhere the adhesive tape that secures the battery cable to the system board.

### Next steps

1. Install the [base cover for computer shipped with a plastic chassis](#).
2. Follow the procedure in [After working inside your computer](#).

## Removing the 54 W battery for computers shipped with a plastic chassis

 **CAUTION:** The information in this removal section is intended for authorized service technicians only.

### Prerequisites

1. Follow the procedure in [Before working inside your computer](#).

 **NOTE:** Ensure that your computer is in Service Mode. For more information see, [Before working inside your computer](#).

2. Remove the [base cover for computers shipped with a plastic chassis](#).

### About this task

 **CAUTION:** Removing the battery resets the BIOS setup settings to default. It is recommended that you note the BIOS setup settings before removing the battery.

The following image indicates the location of the battery and provides a visual representation of the removal procedure.

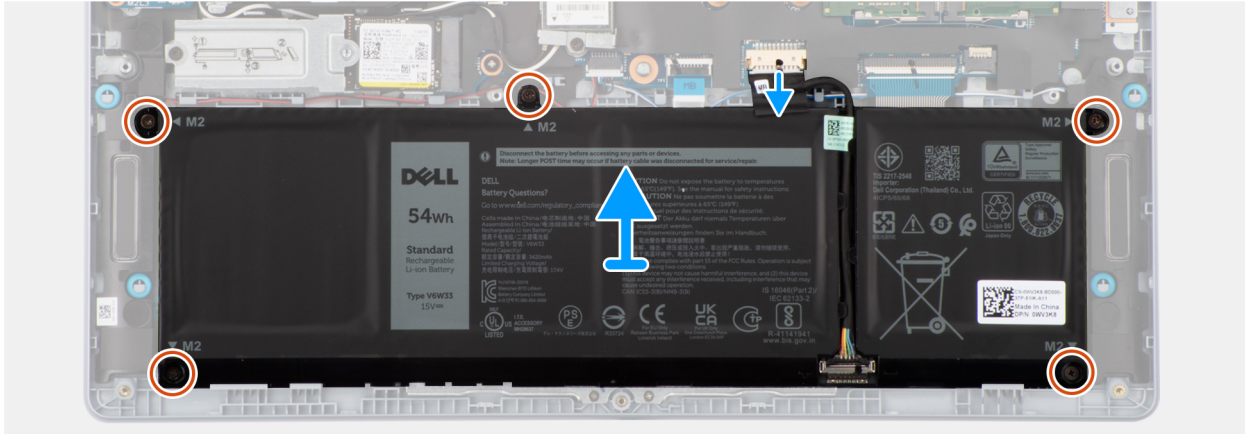
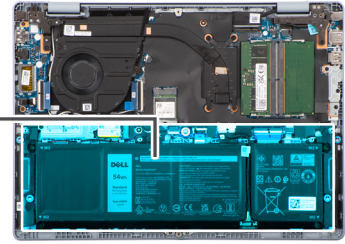
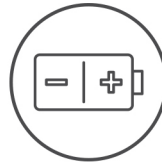

Figure 22. Removing the battery

### Steps

1. Peel the tape that secures the battery cable to the system board and disconnect the battery cable from the connector (BATT1) on the system board.
2. Remove the five screws (M2x3) that secure the battery to the palm-rest and keyboard assembly.
3. Lift the battery off the palm-rest and keyboard assembly.

## Installing the 54 W battery for computers shipped with a plastic chassis

**CAUTION:** The information in this installation section is intended for authorized service technicians only.

### Prerequisites

If you are replacing a component, remove the existing component before performing the installation process.

### About this task

The following image indicates the location of the battery and provides a visual representation of the installation procedure.

Figure 23. Installing the battery



5x  
M2x3

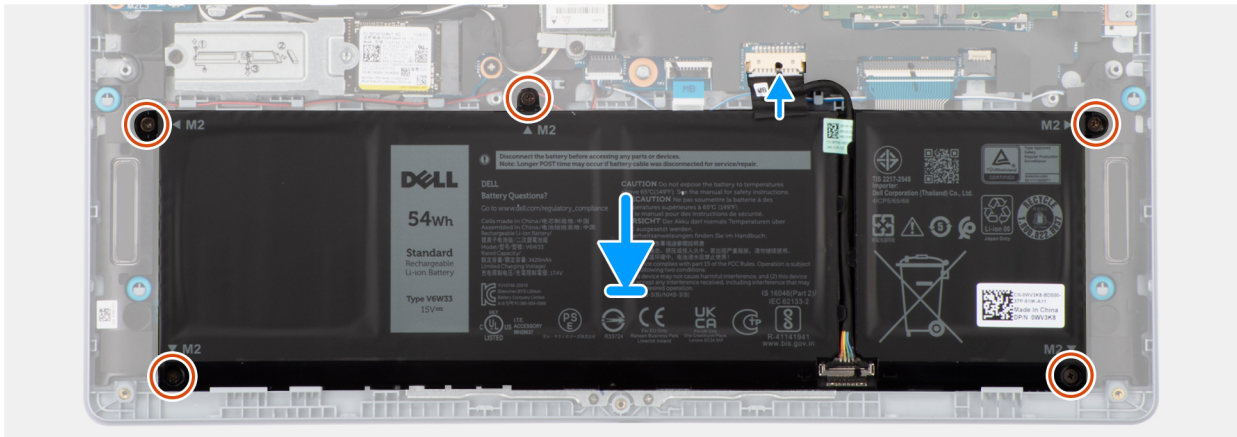
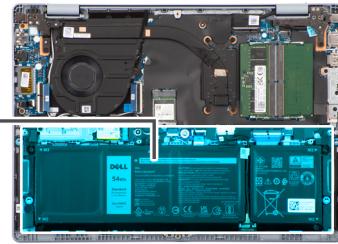
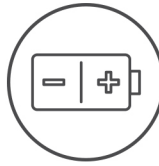

### Steps

1. Align the screw holes on the battery with the screw holes on the palm-rest and keyboard assembly.
2. Replace the five screws (M2x3) that secure the battery to the palm-rest and keyboard assembly.
3. Connect the battery cable to the connector (BATT1) on the system board and adhere the tape that secures the battery cable to the battery.

### Next steps

1. Install the [base cover for computer shipped with a plastic chassis](#).
2. Follow the procedure in [After working inside your computer](#).

## Removing the 54 W battery for computers shipped with an aluminum chassis

**CAUTION:** The information in this removal section is intended for authorized service technicians only.

### Prerequisites

1. Follow the procedure in [Before working inside your computer](#).

**NOTE:** Ensure that your computer is in Service Mode. For more information see, [Before working inside your computer](#).

2. Remove the [base cover for computers shipped with an aluminum chassis](#).

### About this task

**CAUTION:** Removing the battery resets the BIOS setup settings to default. It is recommended that you note the BIOS setup settings before removing the battery.

The following image indicates the location of the battery and provides a visual representation of the removal procedure.



**Figure 24. Removing the battery**

### Steps

1. Peel the tape that secures the battery cable to the system board and disconnect the battery cable from the connector on the system board.
2. Remove the five screws (M2x3) that secure the battery to the palm-rest and keyboard assembly.
3. Lift the battery off the palm-rest and keyboard assembly.

## Installing the 54 W battery for computers shipped with an aluminum chassis

**CAUTION:** The information in this installation section is intended for authorized service technicians only.

### Prerequisites

If you are replacing a component, remove the existing component before performing the installation process.

### About this task

The following image indicates the location of the battery and provides a visual representation of the installation procedure.

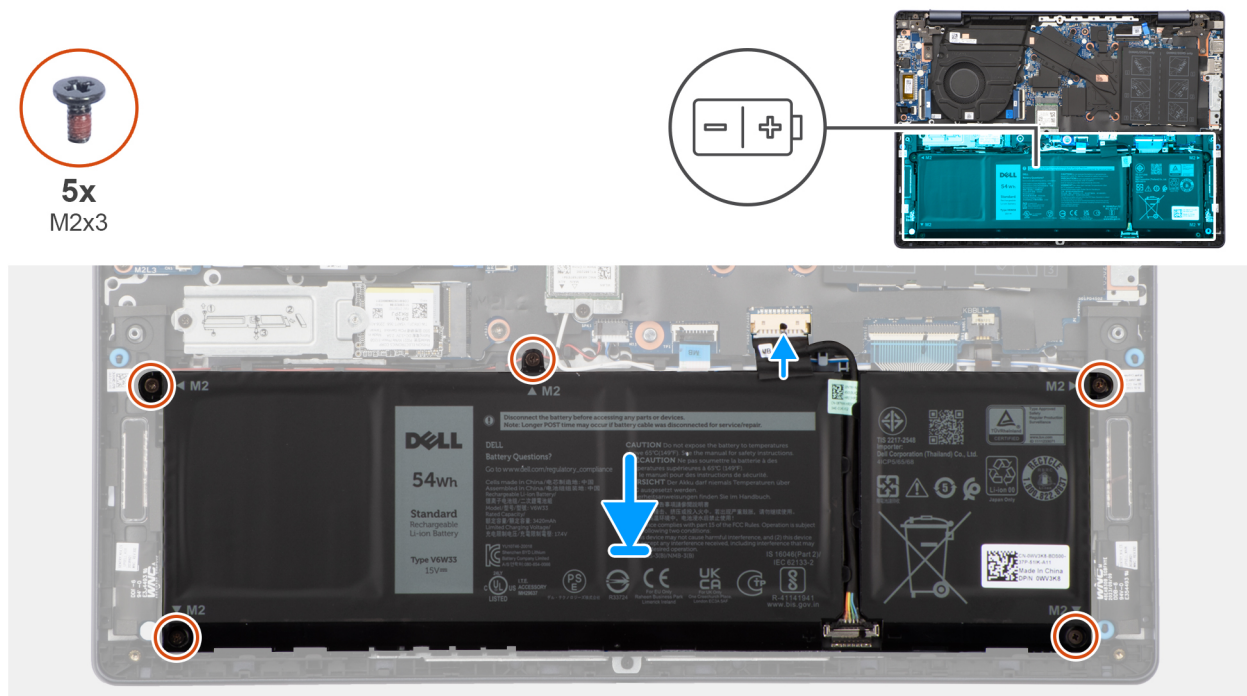

**Figure 25. Installing the battery**

### Steps

1. Align the screw holes on the battery with the screw holes on the palm-rest and keyboard assembly.
2. Replace the five screws (M2x3) that secure the battery to the palm-rest and keyboard assembly.
3. Connect the battery cable to the connector (BATT1) on the system board and adhere the tape that secures the battery cable to the battery.

### Next steps

1. Install the [base cover for computer shipped with an aluminum chassis](#).
2. Follow the procedure in [After working inside your computer](#).

## Disconnecting the battery cable

**CAUTION:** The information in this removal section is intended for authorized service technicians only.

### Prerequisites

1. Follow the procedure in [Before working inside your computer](#).
2. Remove the [base cover for computers shipped with a plastic chassis](#), or the [base cover for computers shipped with an aluminum chassis](#).
3. Remove the [54 W battery for computers shipped with a plastic chassis](#), or the [54 W battery for computers shipped with an aluminum chassis](#).

### About this task

The following image indicates the location of the battery cable and provides a visual representation of the removal procedure.

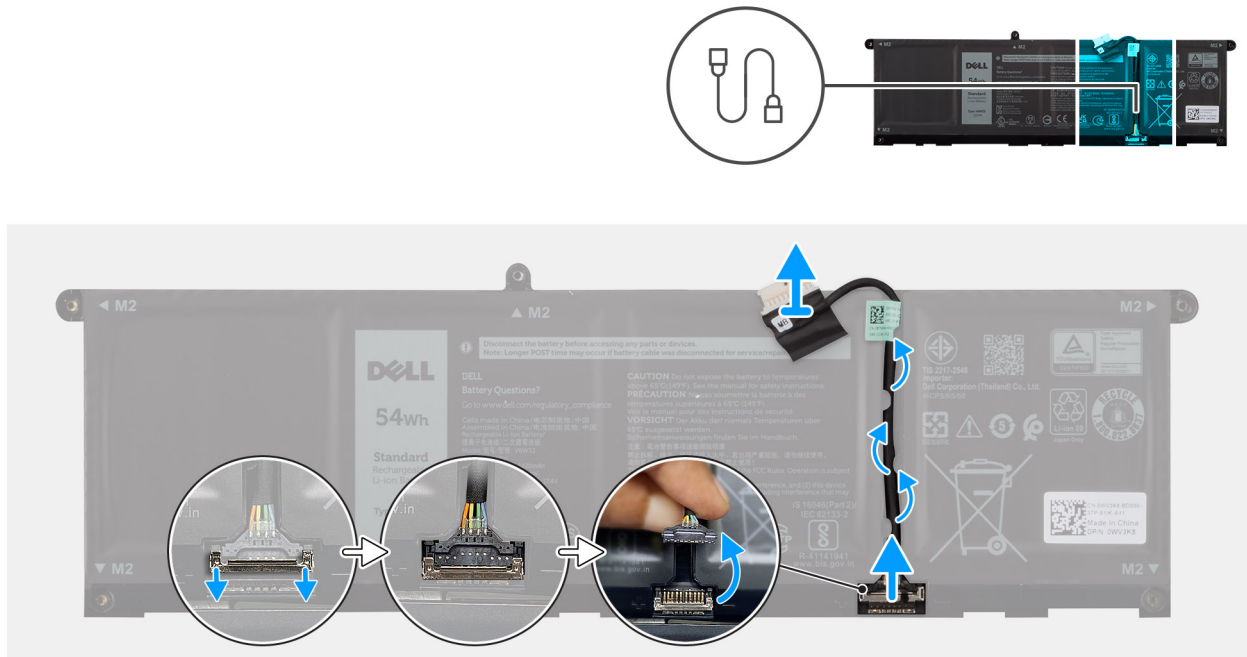

**Figure 26. Disconnecting the battery cable**

### Steps

1. Unroute the battery cable from the routing guides on the battery.
2. Open the latch and disconnect the battery cable from the connector on the battery.

**CAUTION:** DO NOT pull the battery cable to disconnect it from the battery, it may damage the battery or the battery cable.

**NOTE:** To disconnect the battery cable, first push the latch downward to release the connector, and then pull the connector upward to disconnect it from the battery.

## Connecting the battery cable

**CAUTION:** The information in this installation section is intended for authorized service technicians only.

### Prerequisites

If you are replacing a component, remove the existing component before performing the installation procedure.

### About this task

The following image indicates the location of the battery cable and provides a visual representation of the installation procedure.

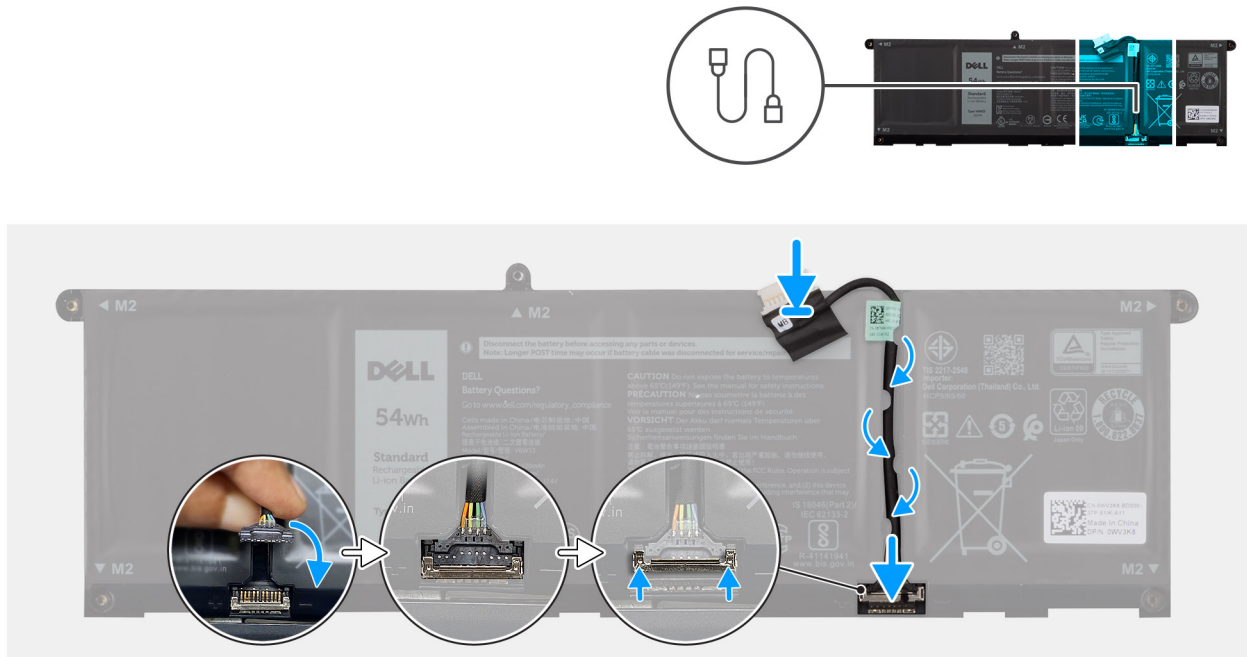

**Figure 27. Connecting the battery cable**

**Steps**

1. Connect the battery cable to the connector on the battery and close the latch.
2. Route the battery cable through the routing guides on the battery.

**Next steps**

1. Install the 54 W battery for computers shipped with a plastic chassis, or the 54 W battery for computers shipped with an aluminum chassis.
2. Install the base cover for computers shipped with a plastic chassis, or the base cover for computers shipped with an aluminum chassis.
3. Follow the procedure in [After working inside your computer](#).

# Removing and installing Customer Replaceable Units (CRUs)

The replaceable components in this chapter are Customer Replaceable Units (CRUs).

 **CAUTION:** Customers can replace only the Customer Replaceable Units (CRUs) following the safety precautions and replacement procedures.

 **NOTE:** The images in this document may differ from your computer depending on the configuration you ordered.

## Memory module

### Removing the memory module for computers shipped with a plastic chassis

#### Prerequisites

1. Follow the procedure in [Before working inside your computer](#).

 **NOTE:** Ensure that your computer is in Service Mode. For more information, see step 6 in, [Before working inside your computer](#).

2. Remove the [base cover for computers shipped with a plastic chassis](#).

#### About this task

The following image indicates the location of the memory module and provides a visual representation of the removal procedure.



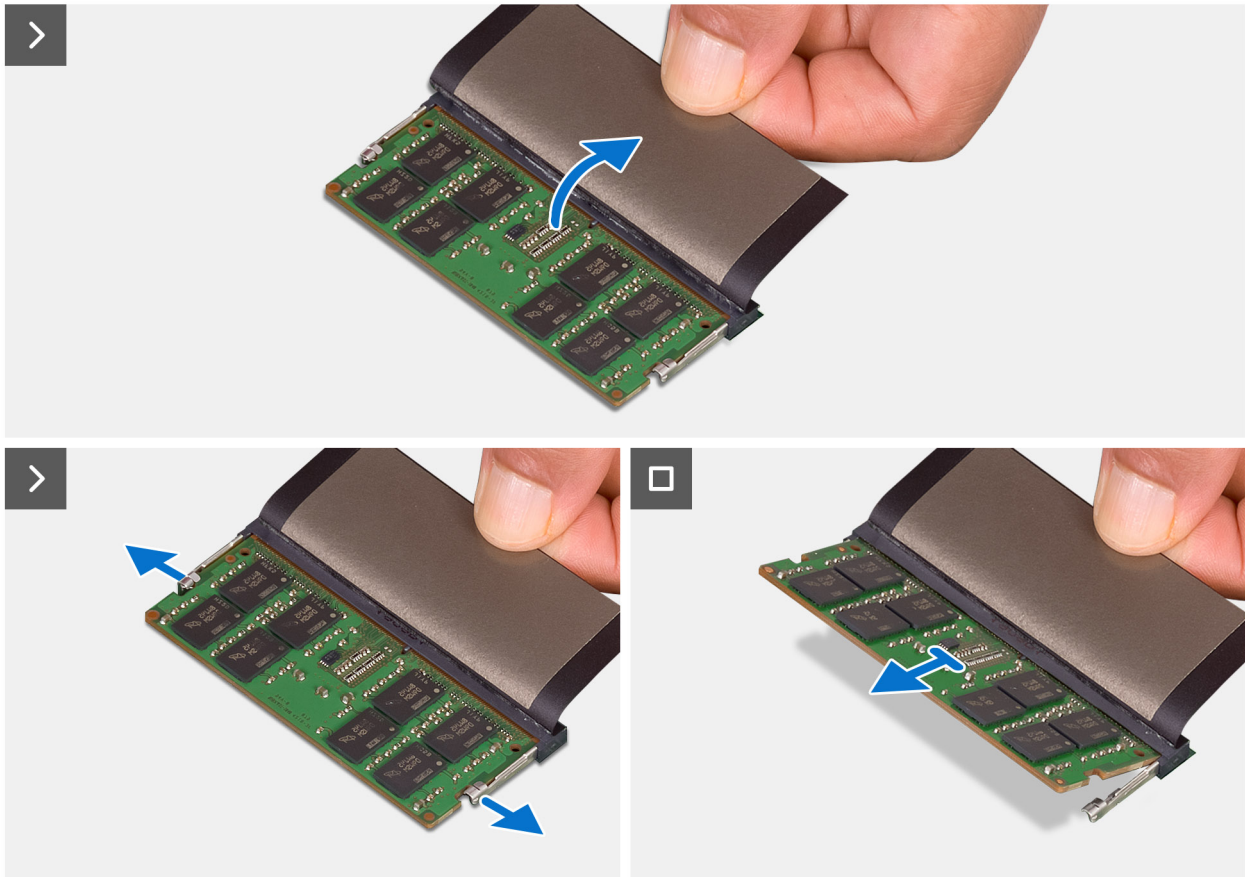
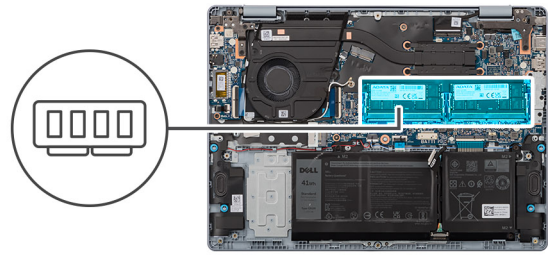

**Figure 28. Removing the memory module**

**Steps**

1. Lift the Mylar to access the memory module.
2. Carefully spread apart the securing-clips on each end of the memory-module slot until the memory module pops-up.

**CAUTION:** To prevent damage to the memory module, hold the memory module by the edges. Do not touch the components or metallic contacts on the memory module as electrostatic discharge (ESD) can inflict severe damage on the components. To read more about ESD protection, see [ESD protection](#).

3. Slide and remove the memory module from the memory-module slot on the system board.

## Installing the memory module for computers shipped with a plastic chassis

**Prerequisites**

If you are replacing a component, remove the existing component before performing the installation process.

### About this task

The following image indicates the location of the memory module and provides a visual representation of the installation procedure.

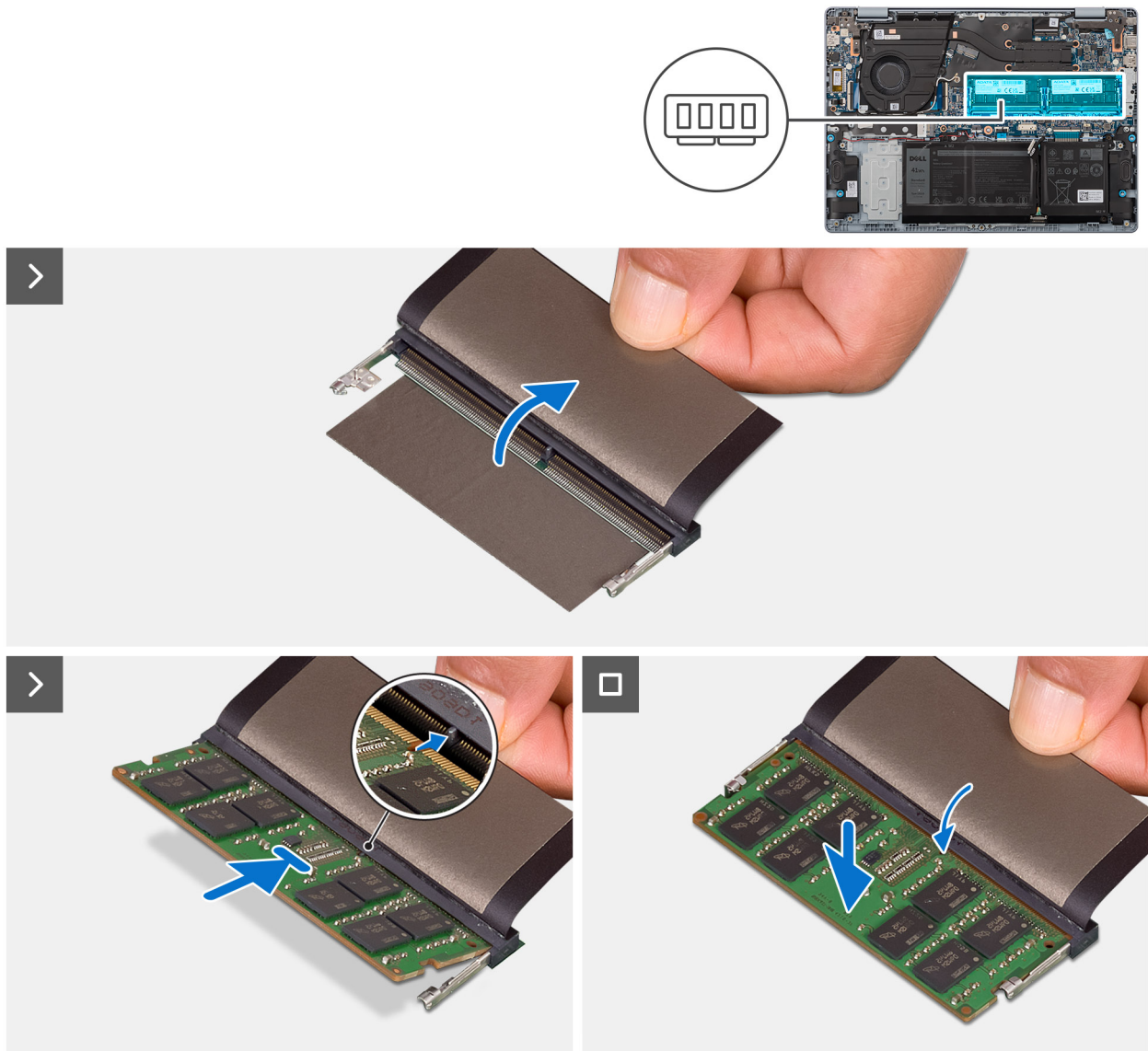

Figure 29. Installing the memory module

### Steps

1. Lift the Mylar to access the memory-module slot.
2. Align the notch on the memory module with the tab on the memory-module slot on the system board.
3. Slide the memory module into the memory-module slot on the system board.

**CAUTION:** To prevent damage to the memory module, hold the memory module by the edges. Do not touch the components or metallic contacts on the memory module as electrostatic discharge (ESD) can inflict severe damage on the components. To read more about ESD protection, see [ESD protection](#).

4. Press down on the memory module till the securing clips click, locking the memory module in place.

### Next steps

1. Install the [base cover for computer shipped with a plastic chassis](#).
2. Follow the procedure in [After working inside your computer](#).

# Removing the memory module for computers shipped with an aluminum chassis

## Prerequisites

1. Follow the procedure in [Before working inside your computer](#).

**NOTE:** Ensure that your computer is in Service Mode. For more information, see step 6 in, [Before working inside your computer](#).

2. Remove the [base cover for computers shipped with an aluminum chassis](#).

## About this task

The following image indicates the location of the memory module and provides a visual representation of the removal procedure.

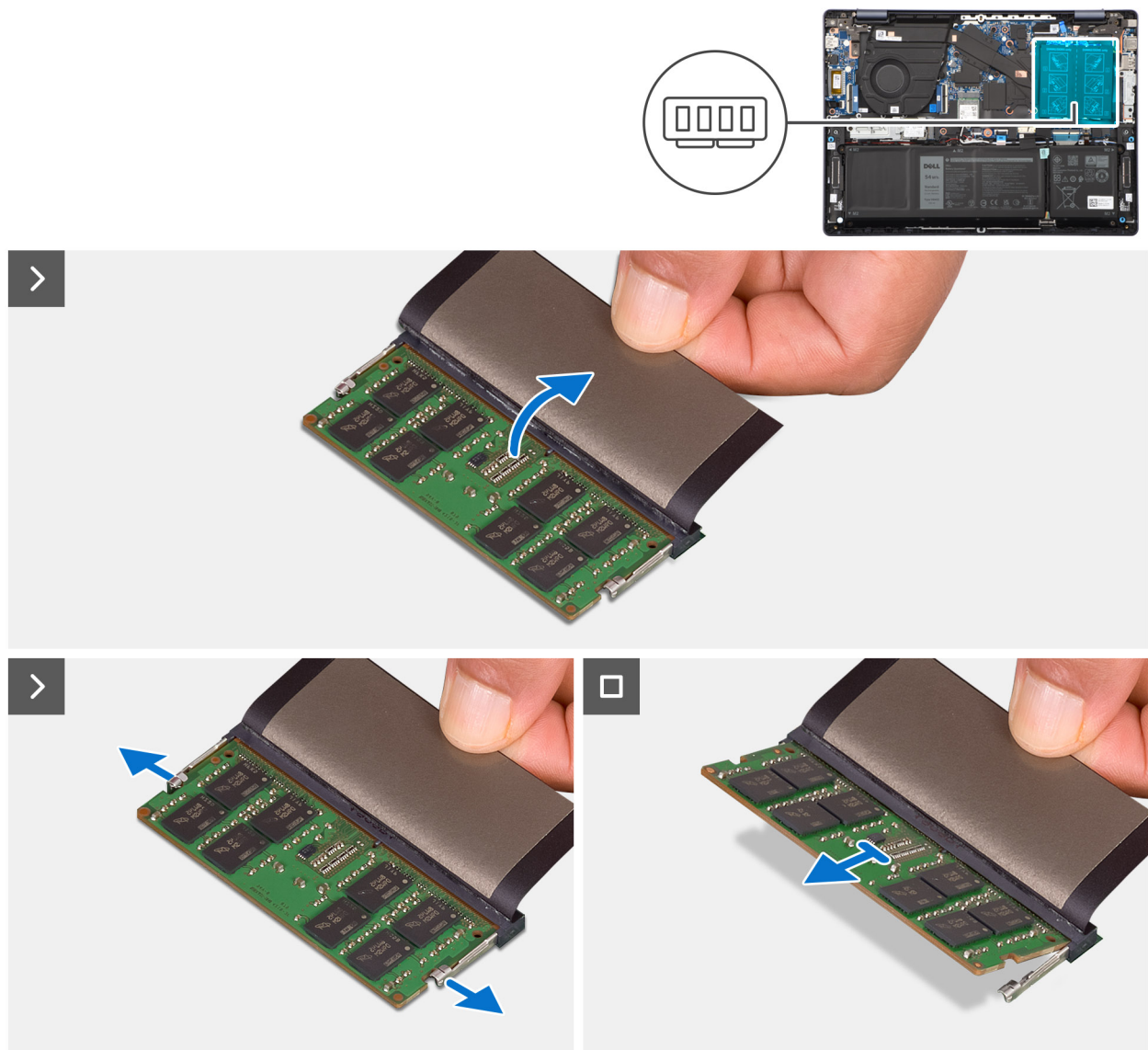

**Figure 30. Removing the memory module**

## Steps

1. Lift the Mylar to access the memory module.
2. Carefully spread apart the securing-clips on each end of the memory-module slot until the memory module pops-up.

**CAUTION:** To prevent damage to the memory module, hold the memory module by the edges. Do not touch the components or metallic contacts on the memory module as electrostatic discharge (ESD) can inflict severe damage on the components. To read more about ESD protection, see [ESD protection](#).

3. Remove the memory module from the memory-module slot on the system board.

## Installing the memory module for computers shipped with an aluminum chassis

### Prerequisites

If you are replacing a component, remove the existing component before performing the installation process.

### About this task

The following image indicates the location of the memory module and provides a visual representation of the installation procedure.

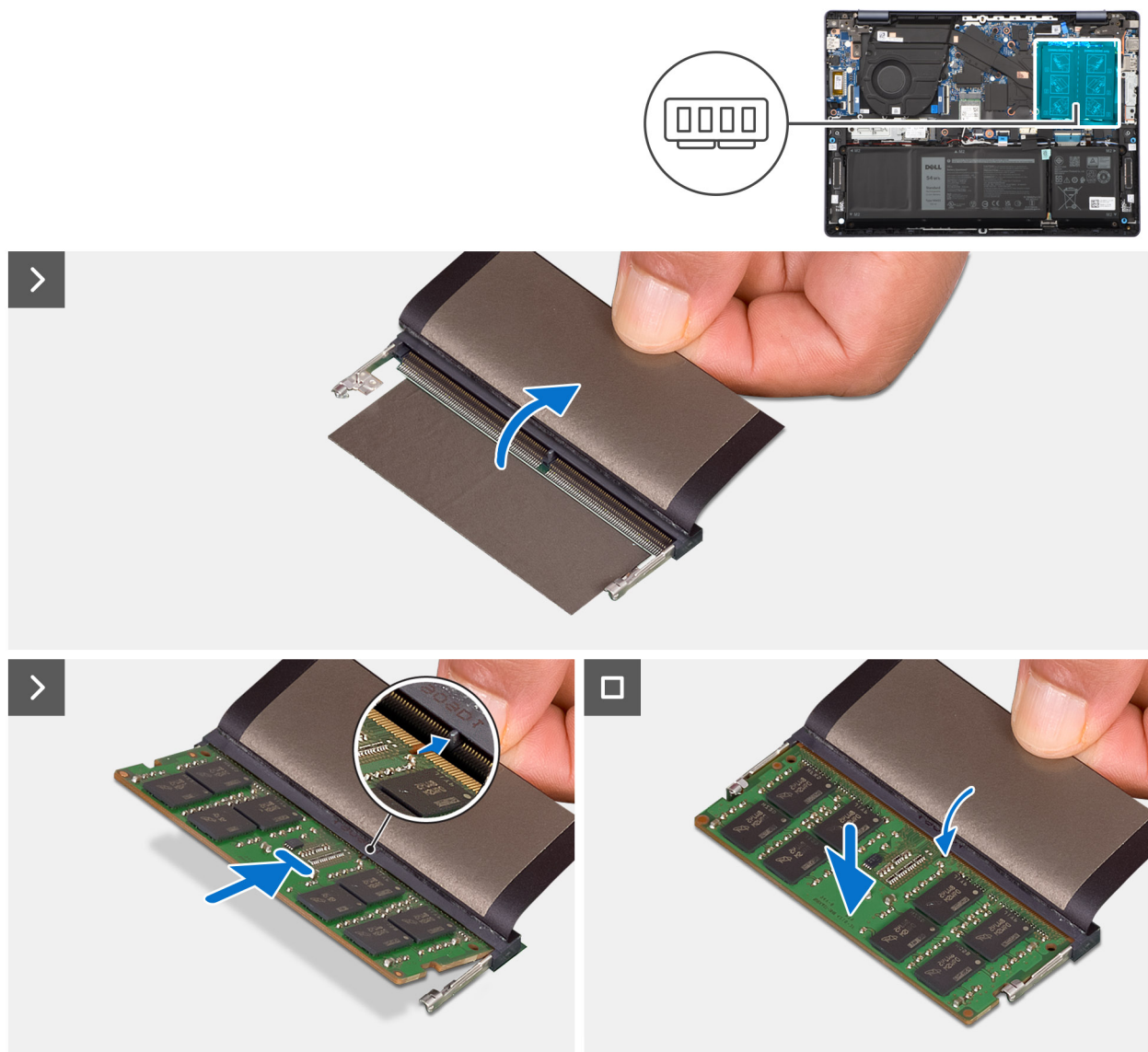



Figure 31. Installing the memory module

### Steps

1. Lift the Mylar to access the memory-module slot.
2. Align the notch on the memory module with the tab on the memory-module slot on the system board.
3. Slide the memory module into the memory-module slot on the system board.

 **CAUTION:** To prevent damage to the memory module, hold the memory module by the edges. Do not touch the components or metallic contacts on the memory module as electrostatic discharge (ESD) can inflict severe damage on the components. To read more about ESD protection, see [ESD protection](#).

4. Press down on the memory module till the securing clips click, locking the memory module in place.

### Next steps

1. Install the [base cover for computer shipped with an aluminum chassis](#).
2. Follow the procedure in [After working inside your computer](#).

## Solid-state drive

### Removing the M.2 2230 solid-state drive for computers shipped with a plastic chassis

#### Prerequisites

1. Follow the procedure in [Before working inside your computer](#).

 **NOTE:** Ensure that your computer is in Service Mode. For more information, see step 6 in, [Before working inside your computer](#).

2. Remove the [base cover for computers shipped with a plastic chassis](#).

#### About this task

 **NOTE:** The support card configuration on the M.2 card slot is:

- M.2 2230 solid-state drive + M.2 2230 solid-state drive mounting bracket

The following image indicates the location of the M.2 2230 solid-state drive and provides a visual representation of the removal procedure.

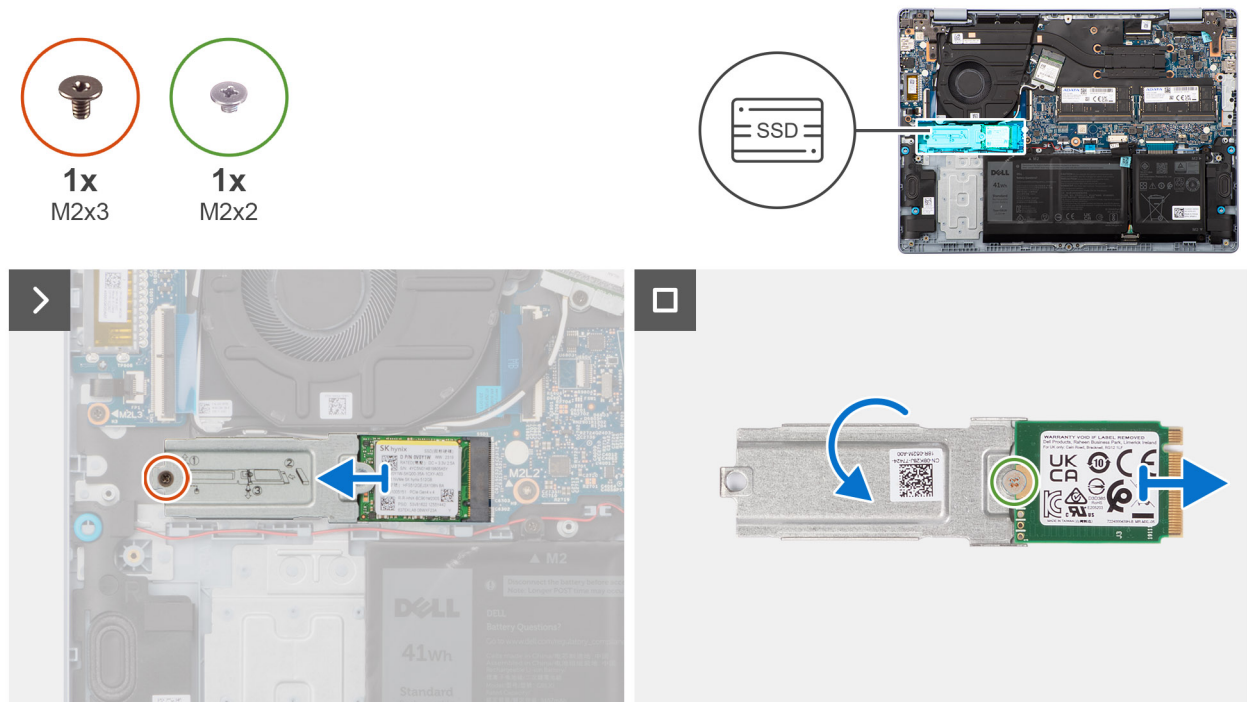

**Figure 32. Removing the solid-state drive**

**Steps**

1. Remove the screw (M2x3) that secures the M.2 2230 solid-state drive assembly to the system board.
2. Slide and lift the M.2 2230 solid-state drive assembly off the system board.
3. Flip over the M.2 2230 solid-state drive assembly.
4. Remove the screw (M2x2) that secures the M.2 2230 solid-state drive to the M.2 2230 solid-state drive mounting bracket.
5. Lift the M.2 2230 solid-state drive off the M.2 2230 solid-state drive mounting bracket.

## Installing the M.2 2230 solid-state drive for computers shipped with a plastic chassis

**Prerequisites**

If you are replacing a component, remove the existing component before performing the installation process.

**About this task**

- NOTE:** The support card configuration on the M.2 card slot is:
- M.2 2230 solid-state drive + M.2 2230 solid-state drive mounting bracket

The following image indicates the location of the M.2 2230 solid-state drive and provides a visual representation of the installation procedure.

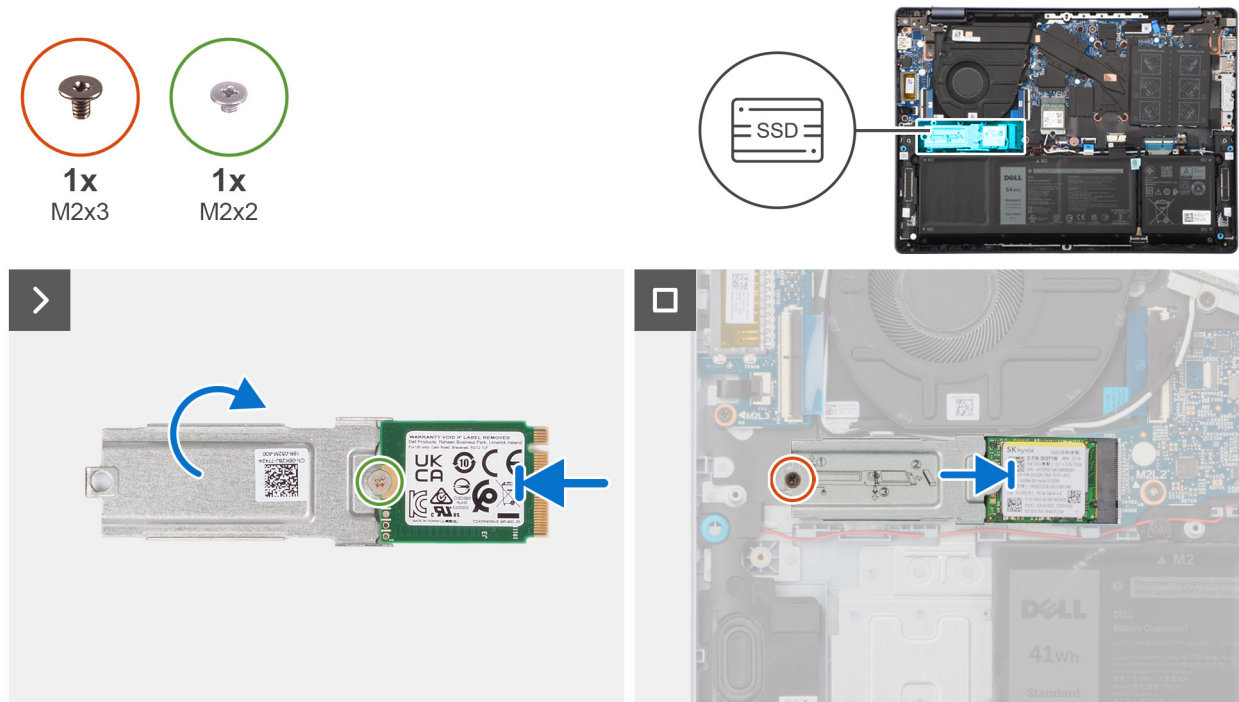

**Figure 33. Installing the solid-state drive**

### Steps

1. Place and align the M.2 2230 solid-state drive on the M.2 2230 solid-state drive mounting bracket.
2. Replace the screw (M2x2) that secures the M.2 2230 solid-state drive to the M.2 2230 solid-state drive mounting bracket.
3. Flip over the M.2 2230 solid-state drive assembly.
4. Align the notch on the M.2 2230 solid-state drive with the tab on the M.2 solid-state drive slot on the system board.
5. Slide and place the M.2 2230 solid-state drive in the M.2 solid-state drive slot on the system board.
6. Replace the screw (M2x3) that secures the M.2 2230 solid-state drive assembly to the system board.

### Next steps

1. Install the [base cover for computer shipped with a plastic chassis](#).
2. Follow the procedure in [After working inside your computer](#).

## Removing the M.2 2230 solid-state drive for computers shipped with an aluminum chassis

### Prerequisites

1. Follow the procedure in [Before working inside your computer](#).

**NOTE:** Ensure that your computer is in Service Mode. For more information, see step 6 in, [Before working inside your computer](#).

2. Remove the [base cover for computers shipped with an aluminum chassis](#).

### About this task

**NOTE:** The support card configuration on the M.2 card slot is:

- M.2 2230 solid-state drive + M.2 2230 solid-state drive mounting bracket

The following image indicates the location of the M.2 2230 solid-state drive and provides a visual representation of the removal procedure.



**Figure 34. Removing the solid-state drive**

### Steps

1. Remove the screw (M2x3) that secures the M.2 2230 solid-state drive assembly to the system board.
2. Slide and lift the M.2 2230 solid-state drive assembly off the system board.
3. Flip over the M.2 2230 solid-state drive assembly.
4. Remove the screw (M2x2) that secures the M.2 2230 solid-state drive to the M.2 2230 solid-state drive mounting bracket.
5. Lift the M.2 2230 solid-state drive off the M.2 2230 solid-state drive mounting bracket.

## Installing the M.2 2230 solid-state drive for computers shipped with an aluminum chassis

### Prerequisites

If you are replacing a component, remove the existing component before performing the installation process.

### About this task

**NOTE:** The support card configuration on the M.2 card slot is:

- M.2 2230 solid-state drive + M.2 2230 solid-state drive mounting bracket

The following image indicates the location of the M.2 2230 solid-state drive and provides a visual representation of the installation procedure.



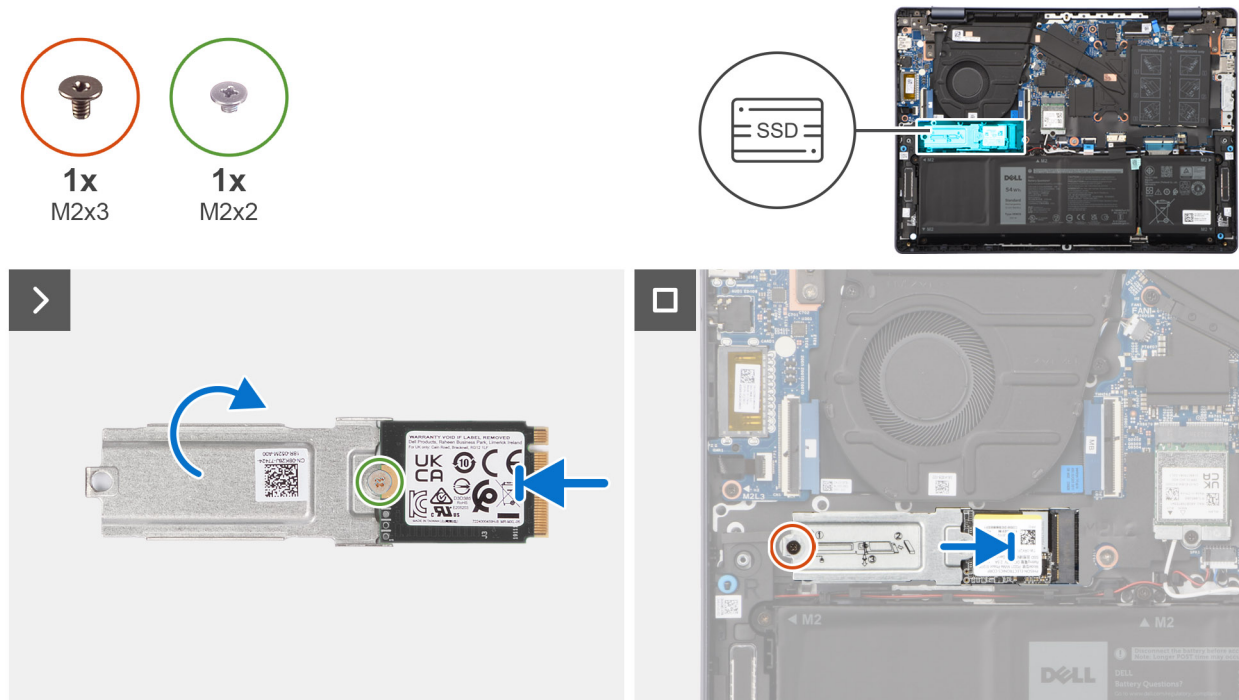

**Figure 35. Installing the solid-state drive**

### Steps

1. Place and align the M.2 2230 solid-state drive on the M.2 2230 solid-state drive mounting bracket.
2. Replace the screw (M2x2) that secures the M.2 2230 solid-state drive to the M.2 2230 solid-state drive mounting bracket.
3. Flip over the M.2 2230 solid-state drive assembly.
4. Align the notch on the M.2 2230 solid-state drive with the tab on the M.2 solid-state drive slot on the system board.
5. Slide and place the M.2 2230 solid-state drive in the M.2 solid-state drive slot on the system board.
6. Replace the screw (M2x3) that secures the M.2 2230 solid-state drive assembly to the system board.

### Next steps

1. Install the [base cover for computer shipped with an aluminum chassis](#).
2. Follow the procedure in [After working inside your computer](#).

## Wireless card

### Removing the wireless card for computers shipped with a plastic chassis

#### Prerequisites

1. Follow the procedure in [Before working inside your computer](#).

**NOTE:** Ensure that your computer is in Service Mode. For more information, see step 6 in, [Before working inside your computer](#).

2. Remove the [base cover for computers shipped with a plastic chassis](#).

#### About this task

The following image indicates the location of the wireless card and provides a visual representation of the removal procedure.



1x  
M2x3

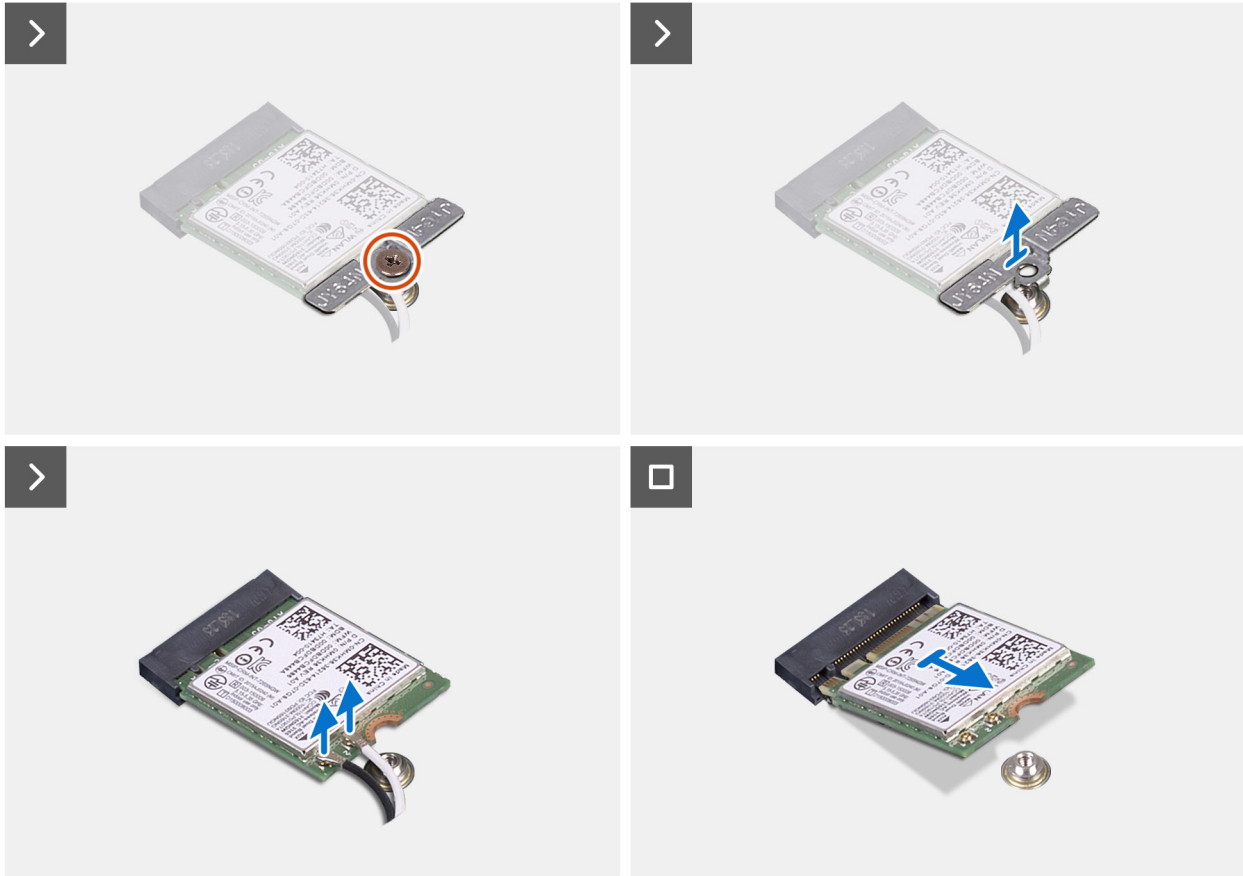
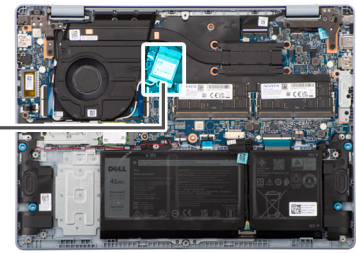

Figure 36. Removing the wireless card

### Steps

1. Remove the screw (M2x3) that secures the wireless-card bracket to the wireless card and system board.
2. Lift the wireless-card bracket off the wireless card.
3. Disconnect the antenna cables from the wireless card.
4. Slide and lift the wireless card off the system board.

## Installing the wireless card for computers shipped with a plastic chassis

### Prerequisites

If you are replacing a component, remove the existing component before performing the installation procedure.

### About this task

The following image indicates the location of the wireless card and provides a visual representation of the installation procedure.



1x  
M2x3

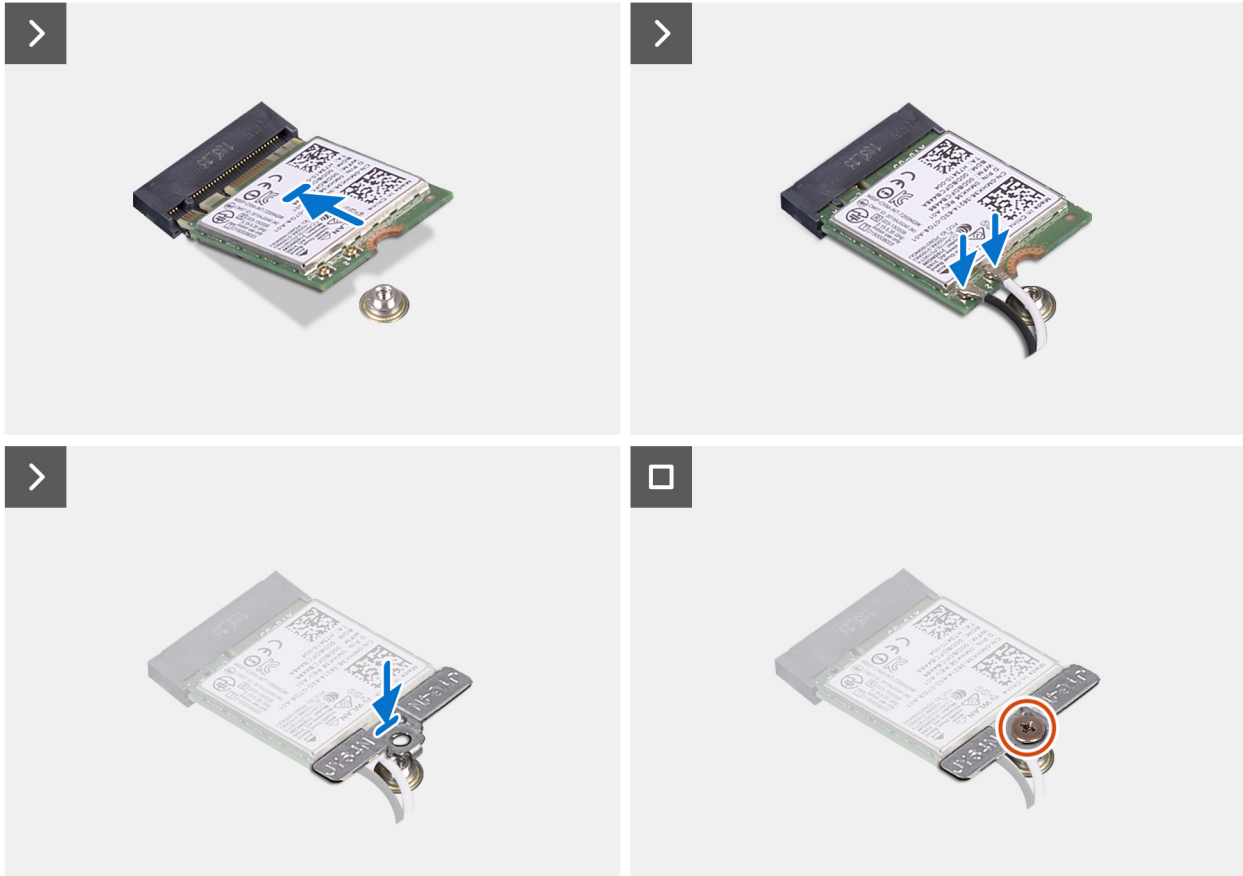
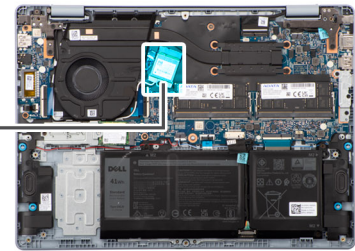

Figure 37. Installing the wireless card

**Steps**

- 1. Connect the antenna cables to the wireless card.

The following table provides the antenna-cable color scheme for the wireless card that is supported by your computer.

Table 30. Antenna-cable color scheme

| Connectors on the wireless card | Antenna-cable color | Silkscreen marking |                    |
|---------------------------------|---------------------|--------------------|--------------------|
| Main                            | White               | MAIN               | △ (white triangle) |
| Auxiliary                       | Black               | AUX                | ▲ (black triangle) |

- 2. Align the notch on the wireless card with the tab on the M.2 wireless-card slot on the system board.
- 3. Slide the wireless card into the M.2 wireless-card slot on the system board.
- 4. Replace the screw (M2x3) that secures the wireless card and wireless-card bracket to the system board.

**Next steps**

- 1. Install the [base cover for computers shipped with a plastic chassis](#).
- 2. Follow the procedure in [After working inside your computer](#).

# Removing the wireless card for computers shipped with an aluminum chassis

## Prerequisites

1. Follow the procedure in [Before working inside your computer](#).

**NOTE:** Ensure that your computer is in Service Mode. For more information, see step 6 in, [Before working inside your computer](#).

2. Remove the [base cover for computers shipped with an aluminum chassis](#).

## About this task

The following image indicates the location of the wireless card and provides a visual representation of the removal procedure.

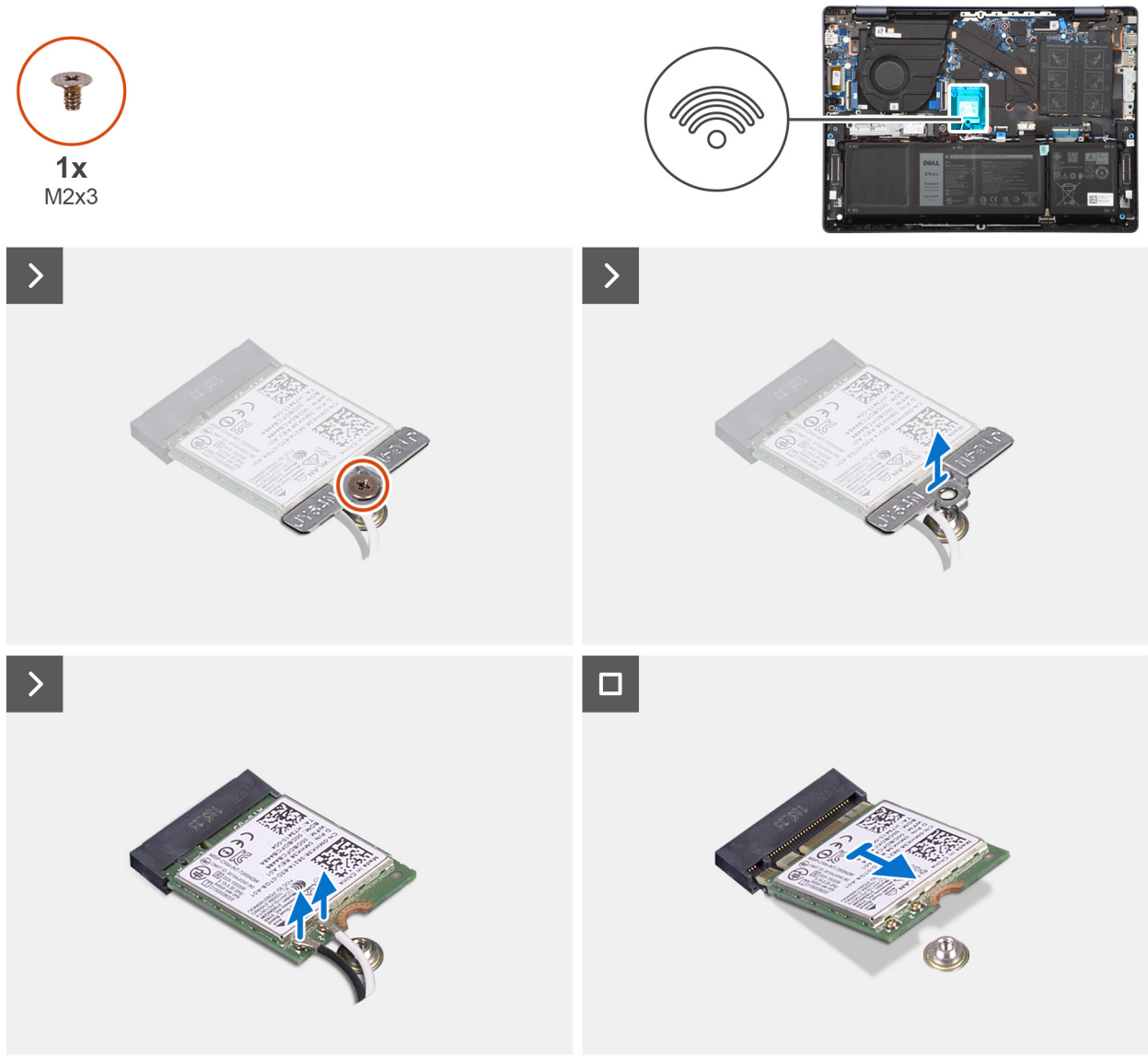

**Figure 38. Removing the wireless card**

## Steps

1. Remove the screw (M2x3) that secures the wireless-card bracket to the wireless card and system board.
2. Lift the wireless-card bracket off the wireless card.
3. Disconnect the antenna cables from the wireless card.

- Slide and lift the wireless card off the system board.

## Installing the wireless card for computers shipped with an aluminum chassis

### Prerequisites

If you are replacing a component, remove the existing component before performing the installation procedure.

### About this task

The following image indicates the location of the wireless card and provides a visual representation of the installation procedure.

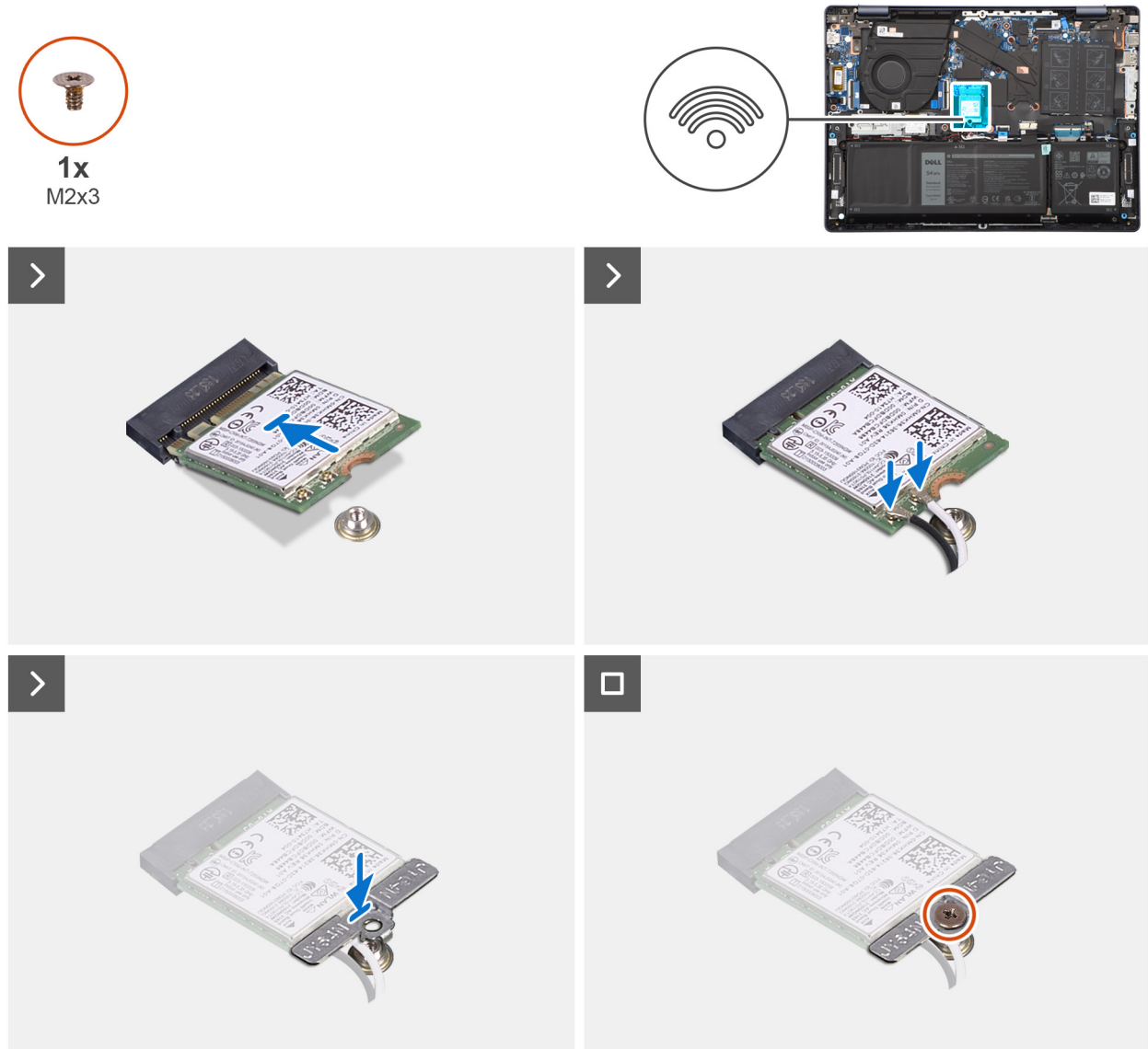

**Figure 39. Installing the wireless card**

### Steps

- Connect the antenna cables to the wireless card.

The following table provides the antenna-cable color scheme for the wireless card that is supported by your computer.

**Table 31. Antenna-cable color scheme**

| Connectors on the wireless card | Antenna-cable color | Silkscreen marking |                    |
|---------------------------------|---------------------|--------------------|--------------------|
| Main                            | White               | MAIN               | △ (white triangle) |
| Auxiliary                       | Black               | AUX                | ▲ (black triangle) |

2. Align the notch on the wireless card with the tab on the M.2 wireless-card slot on the system board.
3. Slide the wireless card into the M.2 wireless-card slot on the system board.
4. Replace the screw (M2x3) that secures the wireless card and wireless-card bracket to the system board.

**Next steps**

1. Install the [base cover for computer shipped with an aluminum chassis](#).
2. Follow the procedure in [After working inside your computer](#).

## System fan

### Removing the system fan for computers shipped with a plastic chassis

**Prerequisites**

1. Follow the procedure in [Before working inside your computer](#).

**NOTE:** Ensure that your computer is in Service Mode. For more information, see step 6 in, [Before working inside your computer](#).

2. Remove the [base cover for computers shipped with a plastic chassis](#).

**About this task**

The following image indicates the location of the system fan and provides a visual representation of the removal procedure.



2x  
M2x4

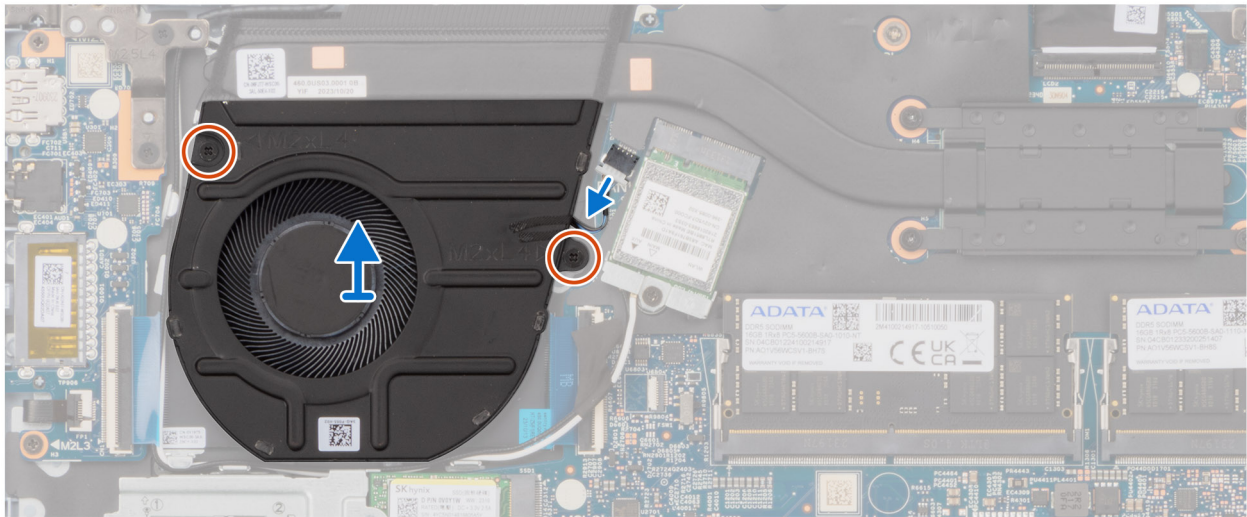
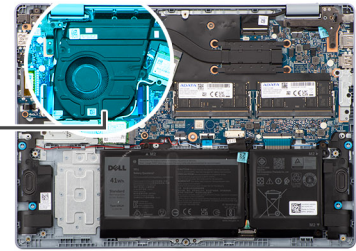
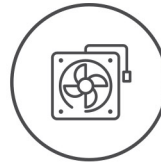

**Figure 40. Removing the fan**

#### Steps

1. Disconnect the fan cable (FN1) from the system board.
2. Remove the two screws (M2x4) that secure the fan to the palm-rest and keyboard assembly.
3. Lift the fan off the palm-rest and keyboard assembly.

## Installing the system fan for computers shipped with a plastic chassis

#### Prerequisites

If you are replacing a component, remove the existing component before performing the installation procedure.

#### About this task

The following image indicates the location of the system fan and provides a visual representation of the installation procedure.

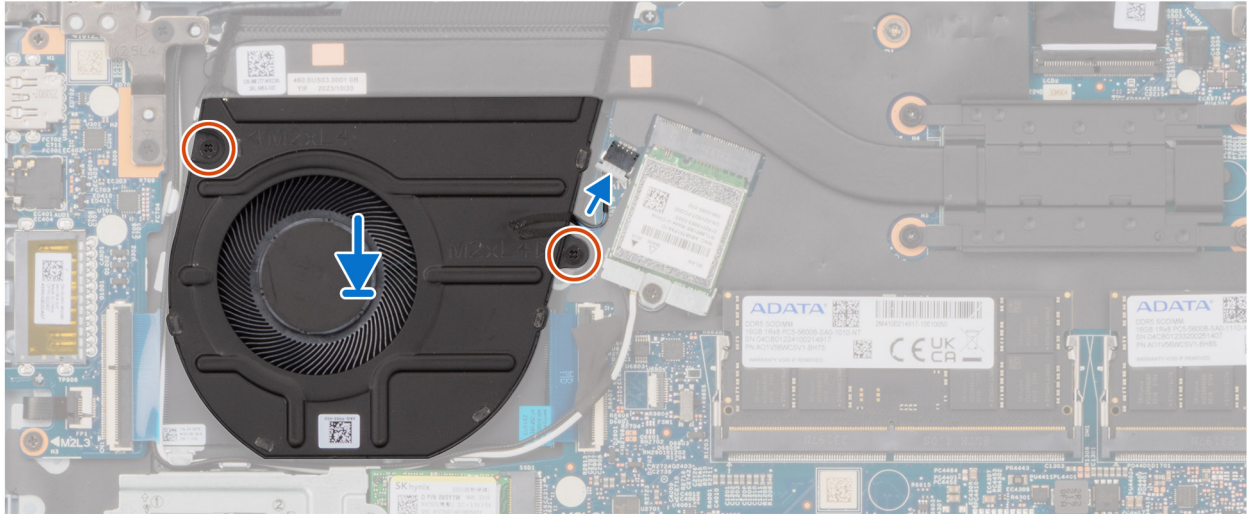
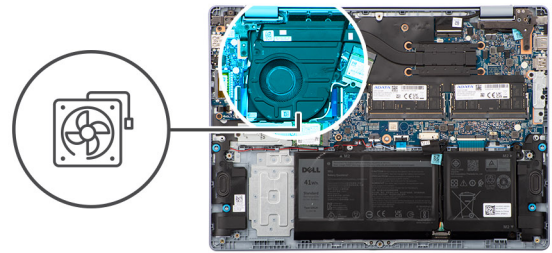

Figure 41. Installing the fan

#### Steps

1. Place the fan on the palm-rest and keyboard assembly.
2. Align the screw holes on the fan with the screw holes on the palm-rest and keyboard assembly.
3. Replace the two screws (M2x4) that secure the fan to the palm-rest and keyboard assembly.
4. Connect the fan cable (FN1) to the system board.

#### Next steps

1. Install the [base cover for computers shipped with a plastic chassis](#).
2. Follow the procedure in [After working inside your computer](#).

## Removing the system fan for computers shipped with an aluminum chassis

#### Prerequisites

1. Follow the procedure in [Before working inside your computer](#).

**NOTE:** Ensure that your computer is in Service Mode. For more information, see step 6 in, [Before working inside your computer](#).

2. Remove the [base cover for computers shipped with an aluminum chassis](#).

#### About this task

The following image indicates the location of the system fan and provides a visual representation of the removal procedure.





2x  
M2x4

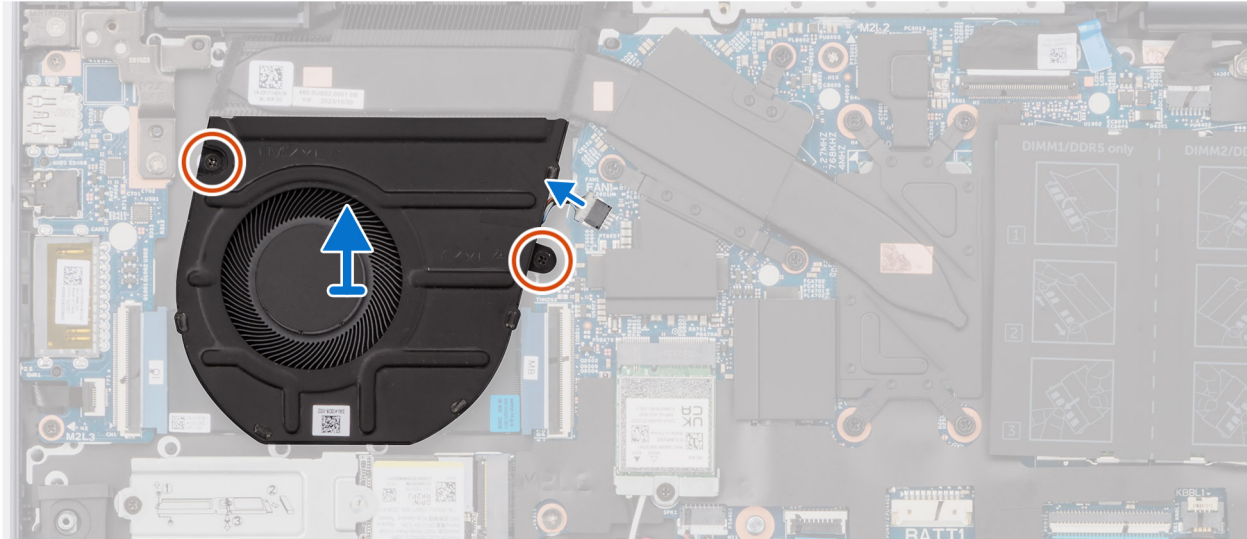
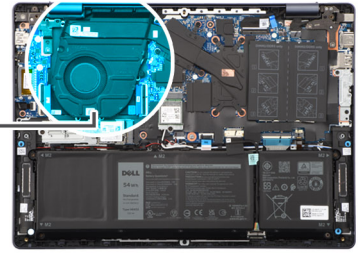
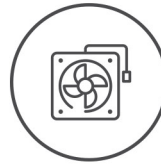

Figure 42. Removing the fan

### Steps

1. Disconnect the fan cable (FN1) from the system board.
2. Remove the two screws (M2x4) that secure the fan to the palm-rest and keyboard assembly.
3. Lift the fan off the palm-rest and keyboard assembly.

## Installing the system fan for computers shipped with an aluminum chassis

### Prerequisites

If you are replacing a component, remove the existing component before performing the installation procedure.

### About this task

The following image indicates the location of the system fan and provides a visual representation of the installation procedure.



2x  
M2x4

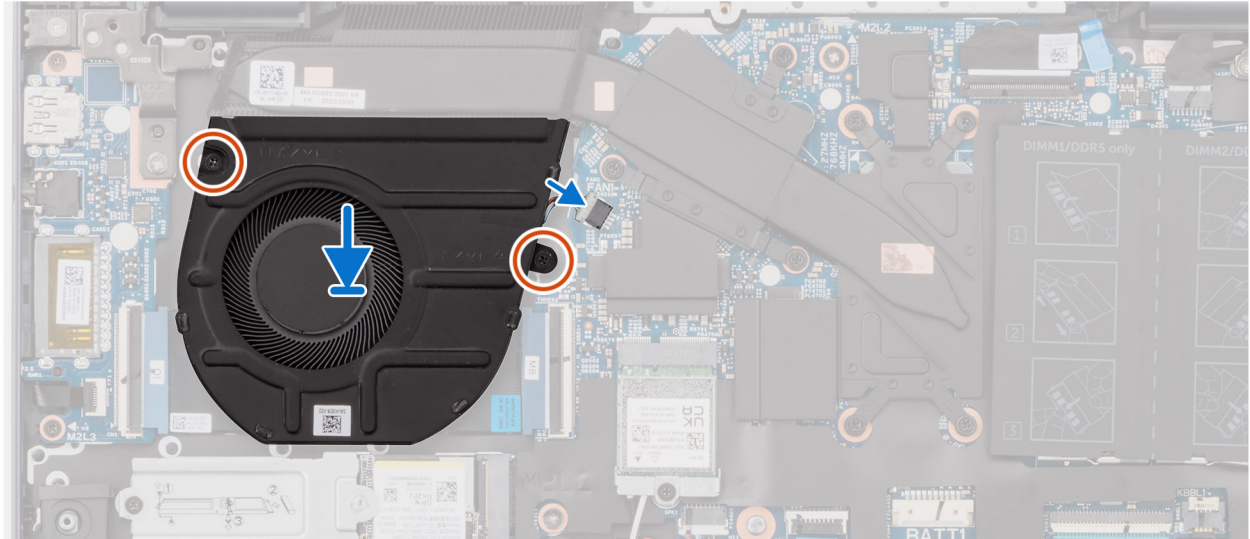
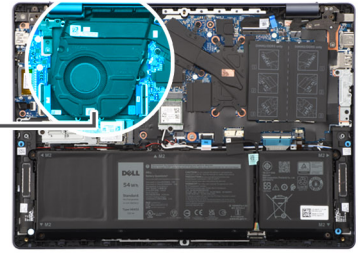
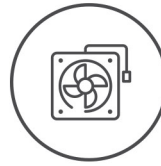

**Figure 43. Installing the fan**

#### Steps

1. Place the system fan on the palm-rest and keyboard assembly.
2. Align the screw holes on the system fan with the screw holes on the palm-rest and keyboard assembly.
3. Replace the two screws (M2x4) that secure the fan to the palm-rest and keyboard assembly.
4. Connect the fan cable (FN1) to the system board.

#### Next steps

1. Install the [base cover for computer shipped with an aluminum chassis](#).
2. Follow the procedure in [After working inside your computer](#).

# Removing and installing Field Replaceable Units (FRUs)

The replaceable components in this chapter are Field Replaceable Units (FRUs).

**CAUTION:** The information in this section is intended for authorized service technicians only.

**CAUTION:** To avoid any potential damage to the component or loss of data, ensure that an authorized service technician replaces the Field Replaceable Units (FRUs).

**CAUTION:** Dell Technologies recommends that these procedures be performed by trained technical repair specialists.

**CAUTION:** Your warranty does not cover damages that may occur during FRU repairs that are not authorized by Dell Technologies.

**NOTE:** The images in this document may differ from your computer depending on the configuration you ordered.

## Heat sink

### Removing the heat sink

**CAUTION:** The information in this section is intended for authorized service technicians only.

#### Prerequisites

1. Follow the procedure in [Before working inside your computer](#).

**NOTE:** Ensure that your computer is in Service Mode. For more information see, [Before working inside your computer](#).

2. Remove the [base cover for computers shipped with a plastic chassis](#) or [base cover for computers shipped with an aluminum chassis](#).

#### About this task

**NOTE:** The heat sink may become hot during normal operation. Allow sufficient time for the heat sink to cool before you touch it.

**NOTE:** For maximum cooling of the processor, do not touch the heat-transfer areas on the heat sink. The oils in your skin can reduce the heat-transfer capability of the thermal grease.

The following image indicates the location of the battery and provides a visual representation of the removal procedure.

**Figure 44. Removing the heat sink**



4x

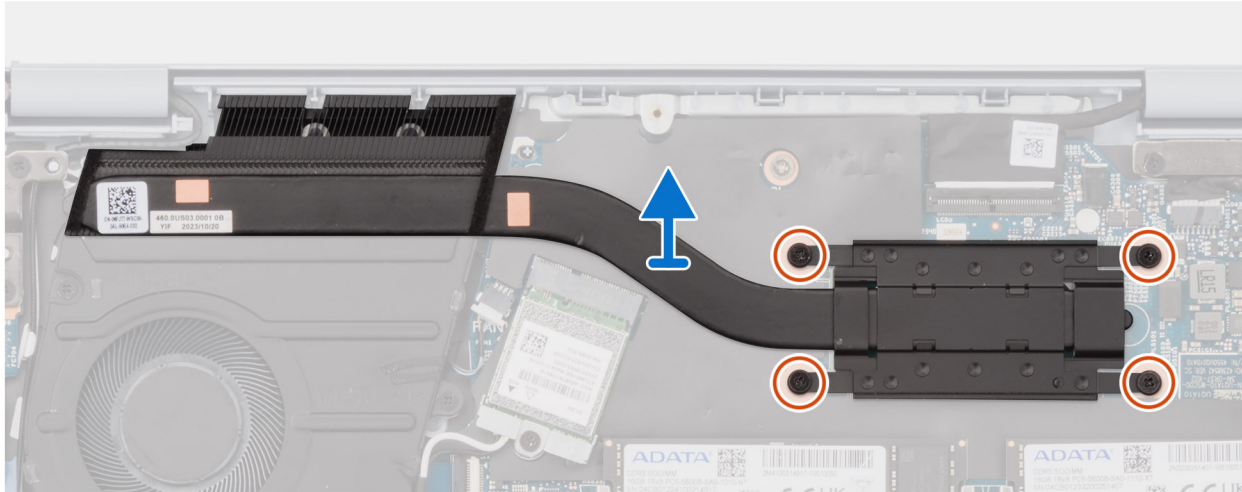
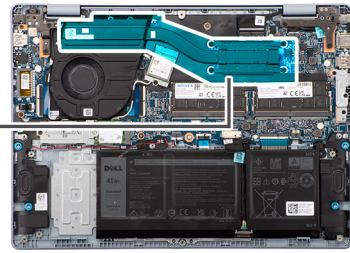

### Steps

1. In reverse sequential order (4 > 3 > 2 > 1), loosen the four captive screws that secure the heat sink to the system board.
2. Lift the heat sink off the system board.

## Installing the heat sink

**CAUTION:** The information in this section is intended for authorized service technicians only.

### Prerequisites

If you are replacing a component, remove the existing component before performing the installation process.

### About this task

The following image indicates the location of the heat sink and provides a visual representation of the installation procedure.

**Figure 45. Installing the heat sink**



4x

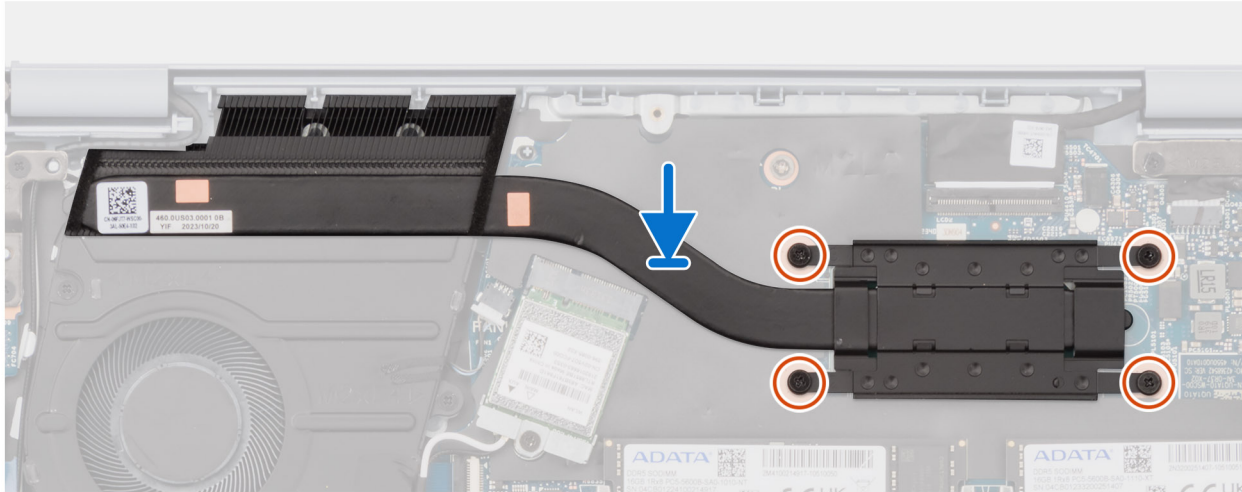
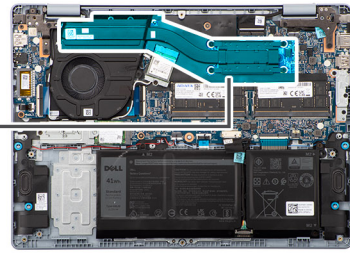

### Steps

1. Place the heat sink on the system board.
2. Align the screw holes on the heat sink with the screw holes on the system board.
3. In sequential order (1 > 2 > 3 > 4) tighten the four captive screws that secure the heat sink to the system board.

### Next steps

1. Install the [base cover for computer shipped with a plastic chassis](#) or [base cover for computer shipped with an aluminum chassis](#).
2. Follow the procedure in [After working inside your computer](#).

## Power-adapter port

### Removing the power-adapter port for computers shipped with a plastic chassis

**CAUTION:** The information in this removal section is intended for authorized service technicians only.

#### Prerequisites

1. Follow the procedure in [Before working inside your computer](#).

**NOTE:** Ensure that your computer is in Service Mode. For more information see, [Before working inside your computer](#).

2. Remove the [base cover for computers shipped with a plastic chassis](#).

#### About this task

**CAUTION:** Removing the battery resets the BIOS setup settings to default. It is recommended that you note the BIOS setup settings before removing the battery.

The following image indicates the location of the power-adaptor port and provides a visual representation of the removal procedure.



**2x**  
M2.5x4

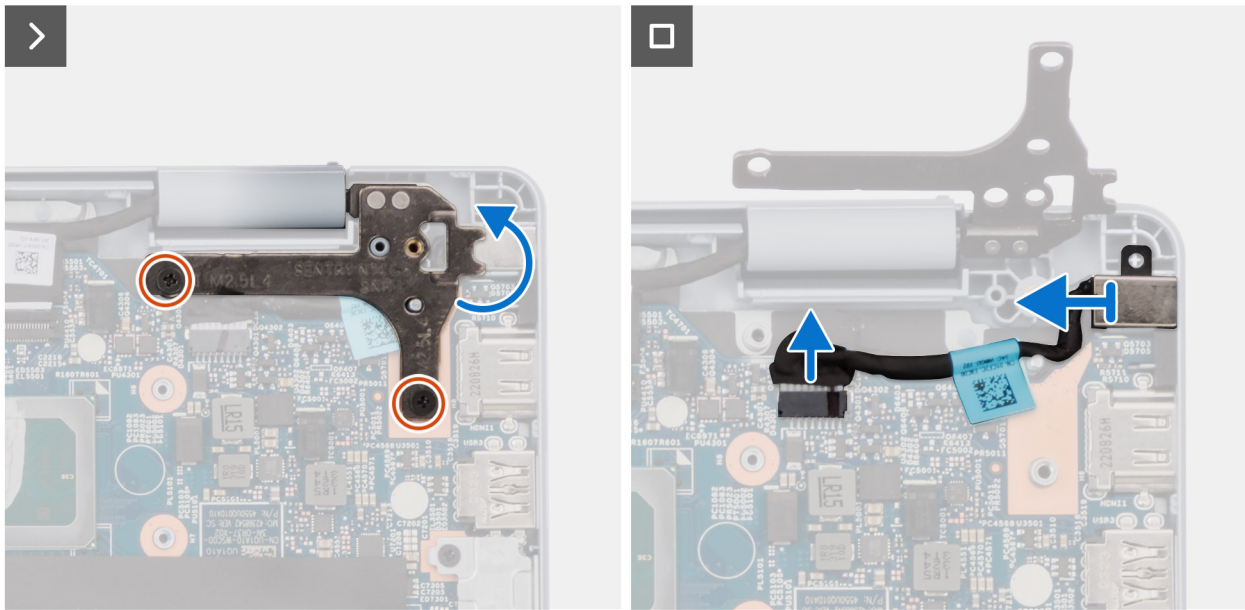
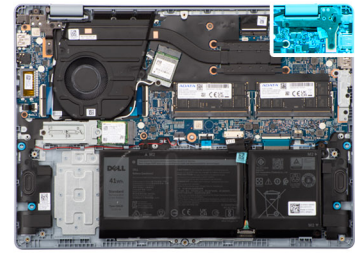

**Figure 46. Removing the power adapter port**

### Steps

1. Remove the two screws (M2.5x4) that secure the right hinge to the palm-rest and keyboard assembly.
2. Rotate to open the right hinge.
3. Peel the tape that secures the power-adaptor cable to the system board and disconnect the power-adaptor cable from the connector (DC IN1) on the system board.
4. Lift the power-adaptor port off the palm-rest and keyboard assembly.

## Installing the power-adaptor port for computers shipped with a plastic chassis

**⚠ CAUTION:** The information in this installation section is intended for authorized service technicians only.

### Prerequisites

If you are replacing a component, remove the existing component before performing the installation process.

### About this task

The following image indicates the location of the power-adaptor port and provides a visual representation of the installation procedure.



2x  
M2.5x4

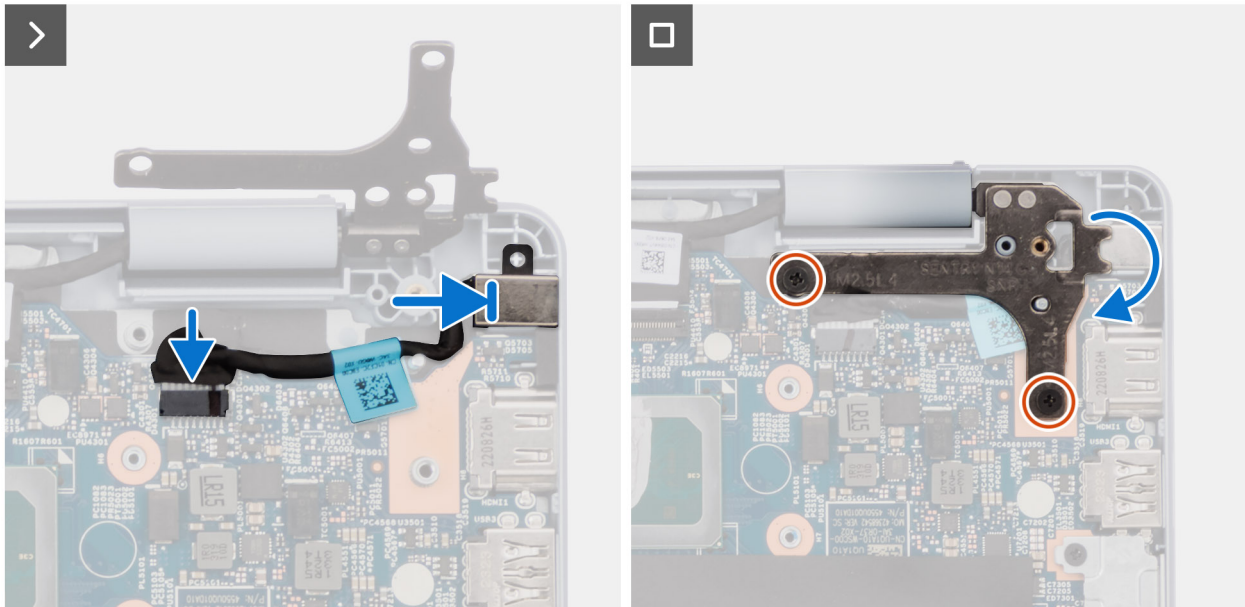
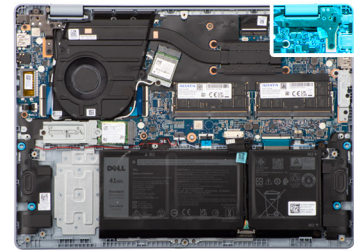

**Figure 47. Installing the power adapter port**

#### Steps

1. Place the power-adapter port in its slot on the palm-rest and keyboard assembly.
2. Connect the power-adapter cable to the connector (DC IN1) on the system board.
3. Adhere the tape that secures the power-adapter cable to the system board.
4. Replace the two screws (M2.5x4) that secure the right hinge to the palm-rest and keyboard assembly.

#### Next steps

1. Install the [base cover](#) for computers shipped with a plastic chassis.
2. Follow the procedure in [After working inside your computer](#).

## Removing the power-adapter port for computers shipped with an aluminum chassis

**CAUTION:** The information in this removal section is intended for authorized service technicians only.

#### Prerequisites

1. Follow the procedure in [Before working inside your computer](#).

**NOTE:** Ensure that your computer is in Service Mode. For more information see, [Before working inside your computer](#).

2. Remove the [base cover](#) for computers shipped with an aluminum chassis.

### About this task

**CAUTION:** Removing the battery resets the BIOS setup settings to default. It is recommended that you note the BIOS setup settings before removing the battery.

The following image indicates the location of the power-adapter port and provides a visual representation of the removal procedure.



**2x**  
M2.5x4.5

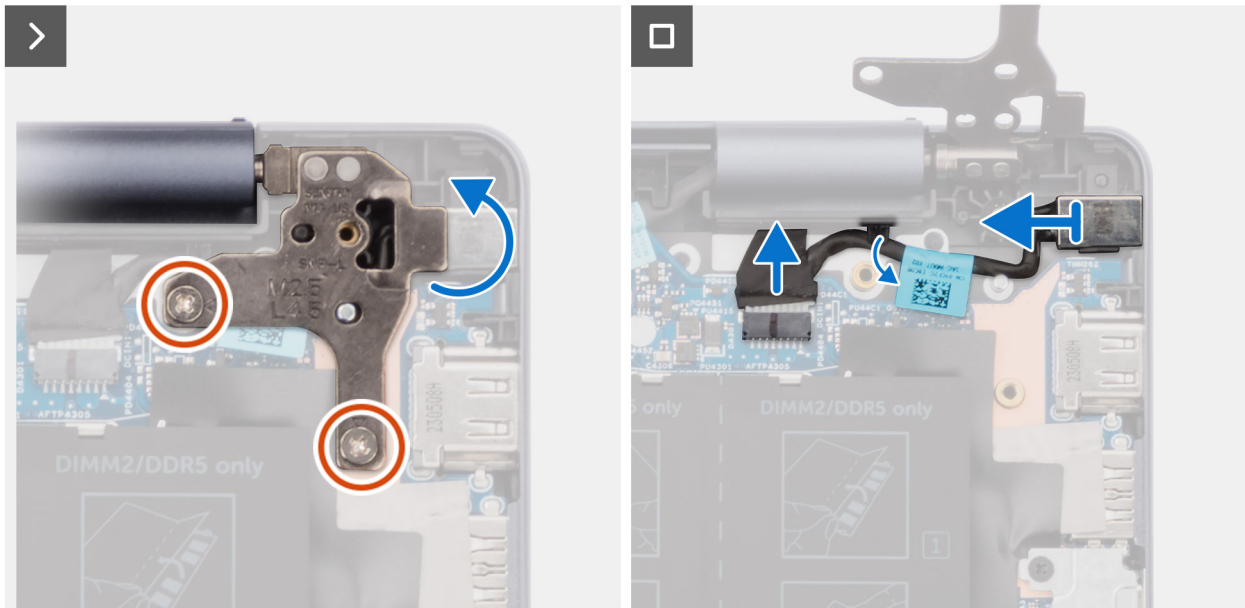
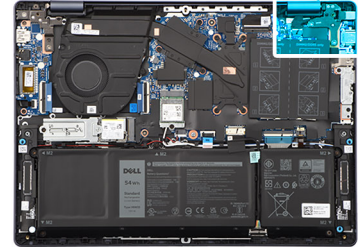

**Figure 48. Removing the power adapter port**

### Steps

1. Remove the two screws (M2.5x4.5) that secure the right hinge to the palm-rest and keyboard assembly.
2. Rotate to open the right hinge.
3. Peel the tape that secures the power-adapter cable to the system board and disconnect the power-adapter cable from the connector (DC IN1) on the system board.
4. Lift the power-adapter port off the palm-rest and keyboard assembly.

## Installing the power-adapter port for computers shipped with an aluminum chassis

**CAUTION:** The information in this installation section is intended for authorized service technicians only.

### Prerequisites

If you are replacing a component, remove the existing component before performing the installation process.

### About this task

The following image indicates the location of the power-adapter port and provides a visual representation of the installation procedure.





**2x**  
M2.5x4.5

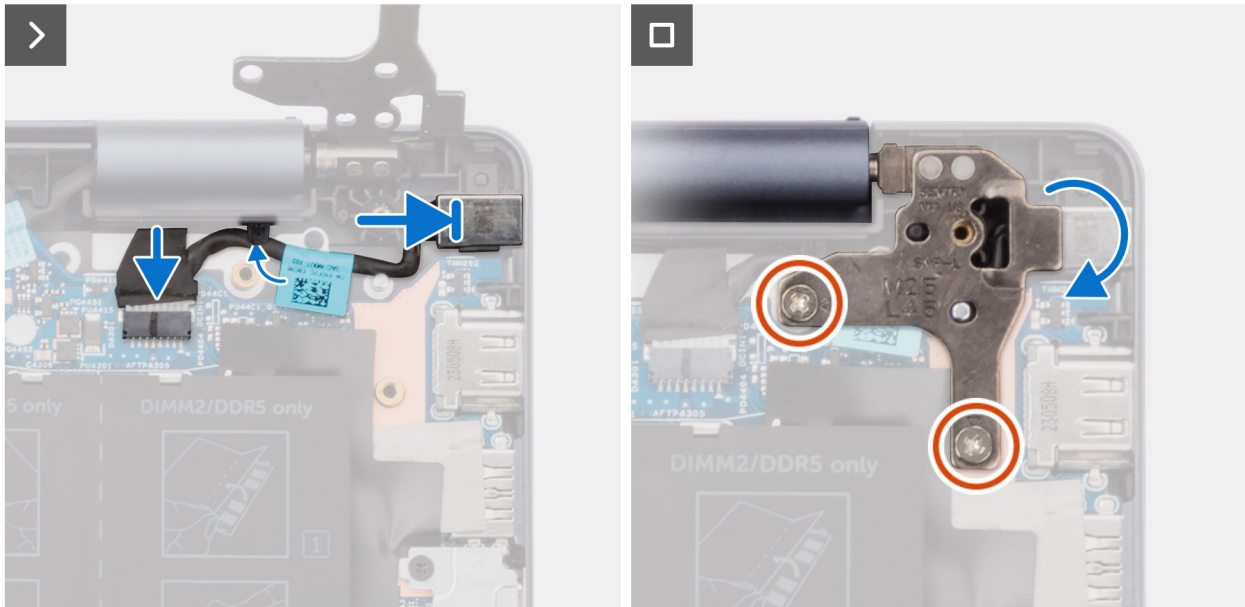
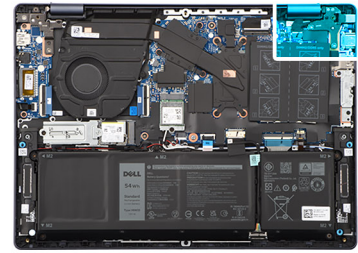

**Figure 49. Installing the power adapter port**

#### Steps

1. Place the power-adapter port in its slot on the palm-rest and keyboard assembly.
2. Connect the power-adapter cable to the connector (DC IN1) on the system board.
3. Adhere the tape that secures the power-adapter cable to the system board.
4. Rotate to close the right hinge.
5. Replace the two screws (M2.5x4.5) that secure the right hinge to the palm-rest and keyboard assembly.

#### Next steps

1. Install the [base cover for computers shipped with an aluminum chassis](#).
2. Follow the procedure in [After working inside your computer](#).

## I/O board

### Removing the I/O board for computers shipped with a plastic chassis

**CAUTION:** The information in this section is intended for authorized service technicians only.

#### Prerequisites

1. Follow the procedure in [Before working inside your computer](#).

**NOTE:** Ensure that your computer is in Service Mode. For more information see, [Before working inside your computer](#).

2. Remove the [base cover](#) for computers shipped with a plastic chassis.

### About this task

The following image indicates the location of the I/O board and provides a visual representation of the removal procedure.

**Figure 50. Removing the I/O board**

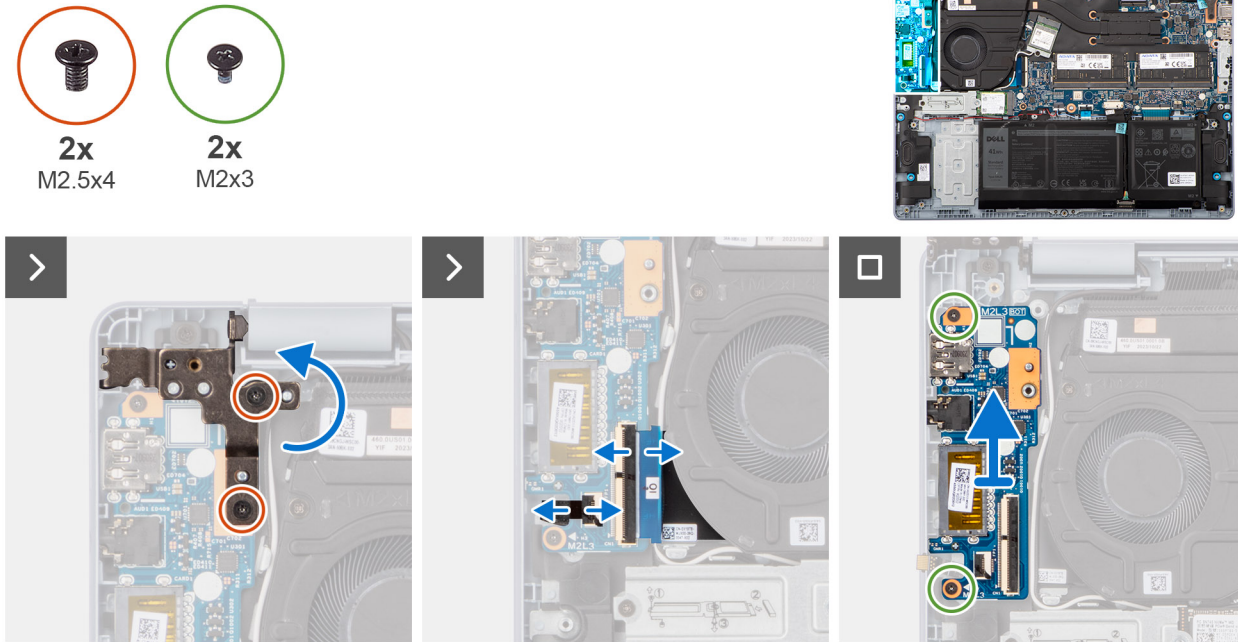

### Steps

1. Remove the two screws (M2.5x4) that secure the left display hinge to the palm-rest and keyboard assembly.
2. Rotate the left display hinge to an angle of 90 degrees.
3. Open the latch and disconnect the power-button with fingerprint reader cable from the I/O board.  
**NOTE:** This step is only applicable to computers shipped with the optional fingerprint reader.
4. Lift the I/O-board cable-connector latch and disconnect the I/O-board cable from the I/O board.
5. Remove the two screws (M2x3) that secure the I/O board to the palm-rest and keyboard assembly.
6. Lift the I/O board off the palm-rest and keyboard assembly.

## Installing the I/O board for computers shipped with a plastic chassis

**CAUTION:** The information in this section is intended for authorized service technicians only.

### Prerequisites

If you are replacing a component, remove the existing component before performing the installation process.

### About this task

The following image indicates the location of the I/O board and provides a visual representation of the installation procedure.

**Figure 51. Installing the I/O board**

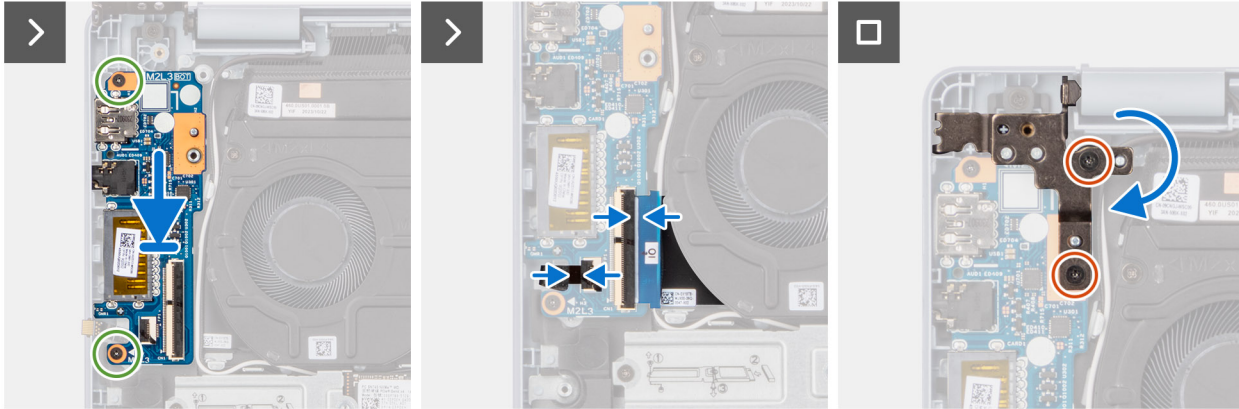
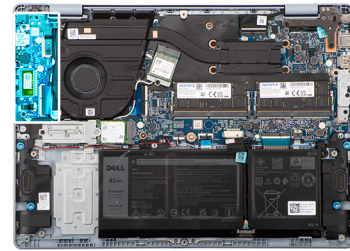
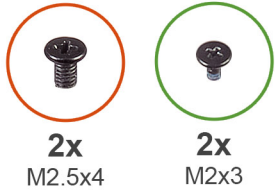

### Steps

1. Place the I/O board on the palm-rest and keyboard assembly.
2. Align the screw holes on the I/O board with the screw holes on the palm-rest and keyboard assembly.
3. Replace the two screws (M2x3) that secure the I/O board to the palm-rest and keyboard assembly.
4. Connect the I/O-board cable to the connector on the I/O board and close the latch.
5. Connect the power-button with fingerprint-reader cable to the connector on the I/O board and close the latch.

**NOTE:** This step is only applicable to computers shipped with the optional fingerprint reader.

6. Close the left display hinge and align the screw holes on the left display hinge with the screw holes on the I/O board.
7. Replace the two screws (M2.5x4) that secure the left display hinge to the palm-rest and keyboard assembly.

### Next steps

1. Install the [base cover for computers shipped with a plastic chassis](#).
2. Follow the procedure in [After working inside your computer](#).

## Removing the I/O board for computers shipped with an aluminum chassis

**CAUTION:** The information in this section is intended for authorized service technicians only.

### Prerequisites

1. Follow the procedure in [Before working inside your computer](#).

**NOTE:** Ensure that your computer is in Service Mode. For more information see, [Before working inside your computer](#).

2. Remove the [base cover for computers shipped with an aluminum chassis](#).

### About this task

The following image indicates the location of the I/O board and provides a visual representation of the removal procedure.

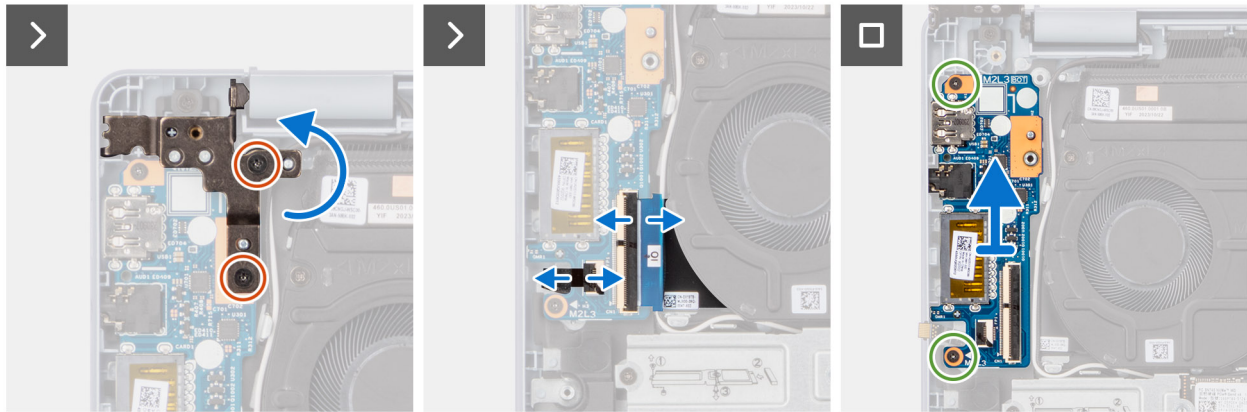
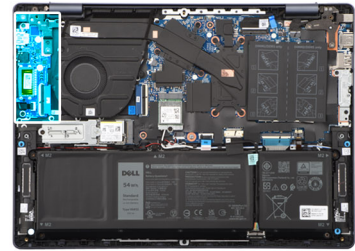
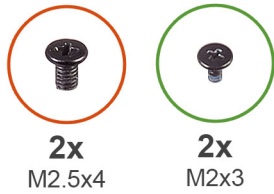

**Figure 52. Removing the I/O board**

### Steps

1. Remove the two screws (M2.5x4) that secure the left display hinge to the palm-rest and keyboard assembly.
2. Rotate the left display hinge to an angle of 90 degrees.
3. Lift the latch and disconnect the power-button with fingerprint reader cable from the I/O board.
  - NOTE:** This step is only applicable to computers shipped with the optional fingerprint reader.
4. Lift the I/O-board cable-connector latch and disconnect the I/O-board cable from the I/O board.
5. Remove the two screws (M2x3) that secure the I/O board to the palm-rest and keyboard assembly.
6. Lift the I/O board off the palm-rest and keyboard assembly.

## Installing the I/O board for computers shipped with an aluminum chassis

**CAUTION:** The information in this section is intended for authorized service technicians only.

### Prerequisites

If you are replacing a component, remove the existing component before performing the installation process.

### About this task

The following image indicates the location of the I/O board and provides a visual representation of the installation procedure.

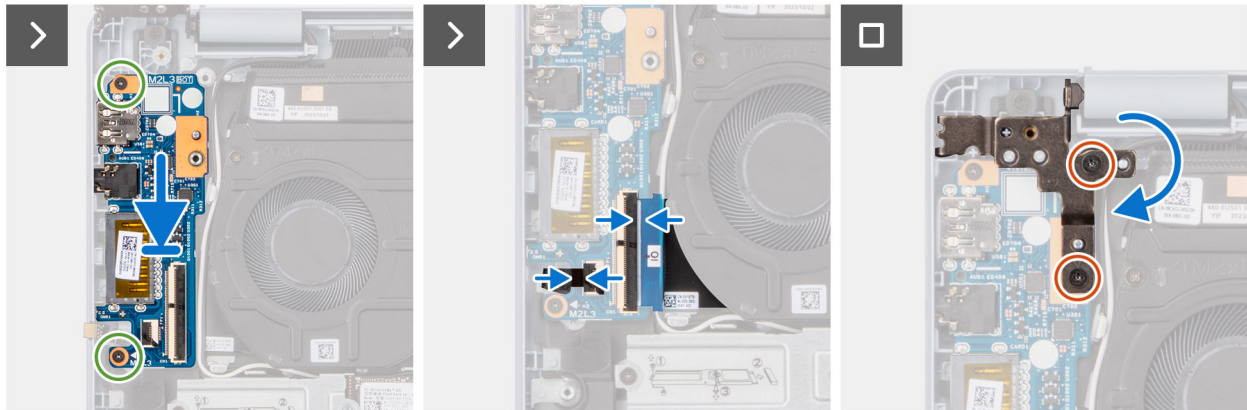
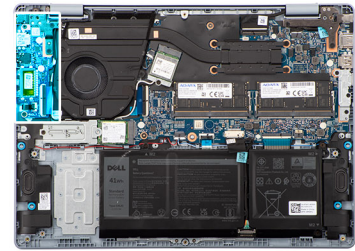
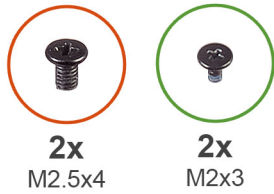

**Figure 53. Installing the I/O board**

#### Steps

1. Place the I/O board on the palm-rest and keyboard assembly.
2. Align the screw holes on the I/O board with the screw holes on the palm-rest and keyboard assembly.
3. Replace the two screws (M2x3) that secure the I/O board to the palm-rest and keyboard assembly.
4. Connect the I/O-board cable to the connector on the I/O board and close the latch.
5. Connect the power-button with fingerprint-reader cable to the connector on the I/O board and close the latch.

**NOTE:** This step is only applicable to computers shipped with the optional fingerprint reader.

6. Close the left display hinge and align the screw holes on the left display hinge with the screw holes on the I/O board.
7. Replace the two screws (M2.5x4) that secure the left display hinge to the palm-rest and keyboard assembly.

#### Next steps

1. Install the [base cover](#) for computers shipped with an aluminum chassis.
2. Follow the procedure in [After working inside your computer](#).

## Power button with fingerprint reader

### Removing the power-button with fingerprint reader for computers shipped with a plastic chassis

**CAUTION:** The information in this section is intended for authorized service technicians only.

#### Prerequisites

1. Follow the procedure in [Before working inside your computer](#).

**NOTE:** Ensure that your computer is in Service Mode. For more information see, [Before working inside your computer](#).

2. Remove the [base cover](#) for computers shipped with a plastic chassis.

3. Remove the I/O board for computers shipped with a plastic chassis.

**About this task**

**NOTE:** This procedure is applicable only for computers that are shipped without the optional fingerprint reader.

The following image indicates the location of the power-button and provides a visual representation of the removal procedure.

**Figure 54. Removing the power-button**

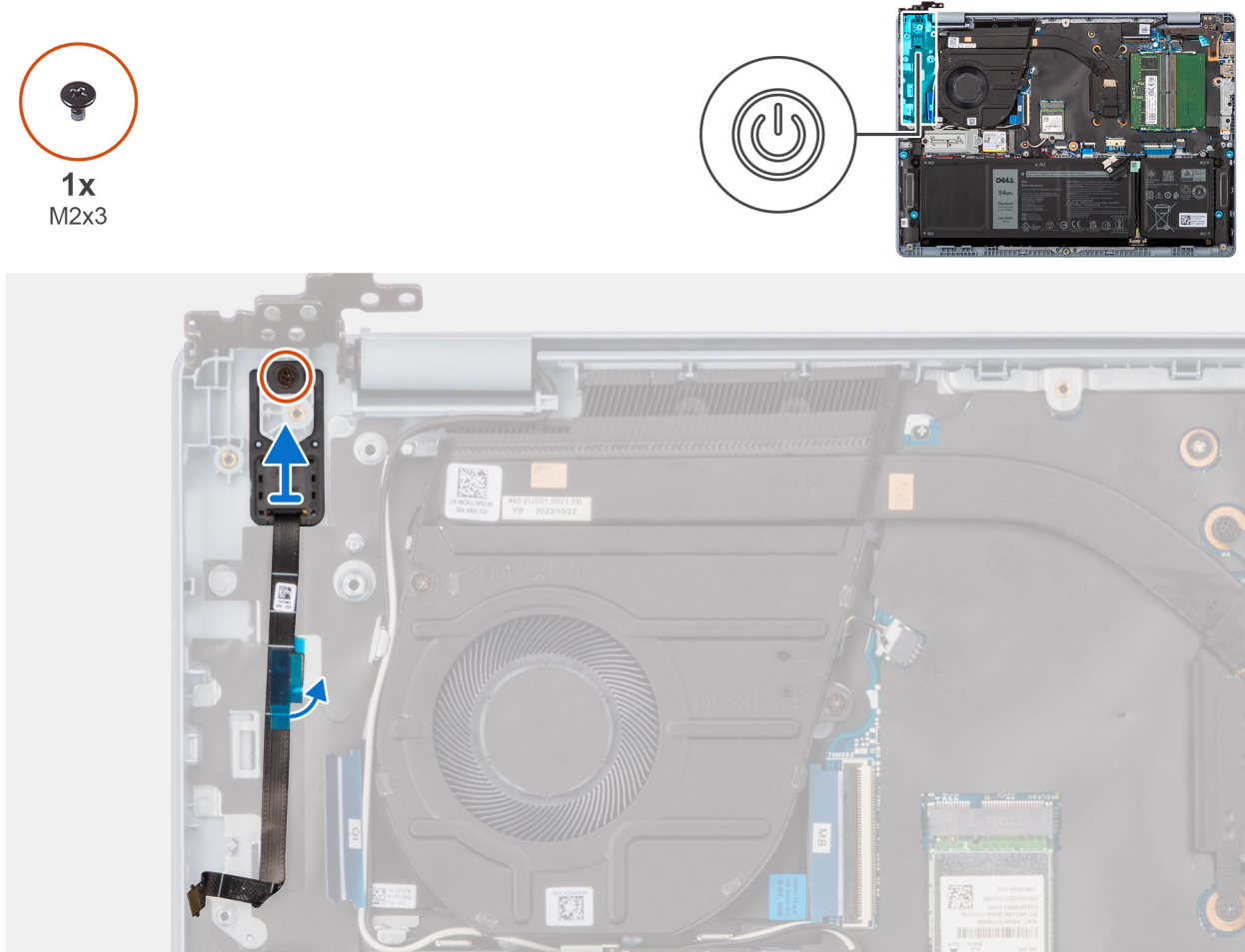

**Steps**

1. Remove the screw (M2x3) that secures the power-button to the palm-rest and keyboard assembly.
2. Lift the power-button off the palm-rest and keyboard assembly.

## Installing the power-button with fingerprint reader for computers shipped with a plastic chassis

**CAUTION:** The information in this section is intended for authorized service technicians only.

**Prerequisites**

If you are replacing a component, remove the existing component before performing the installation procedure.

### About this task

**NOTE:** This procedure is applicable only when you are installing a power-button without the optional fingerprint reader.

The following image indicates the location of the power-button and provides a visual representation of the installation procedure.

**Figure 55. Installing the power-button with fingerprint reader**

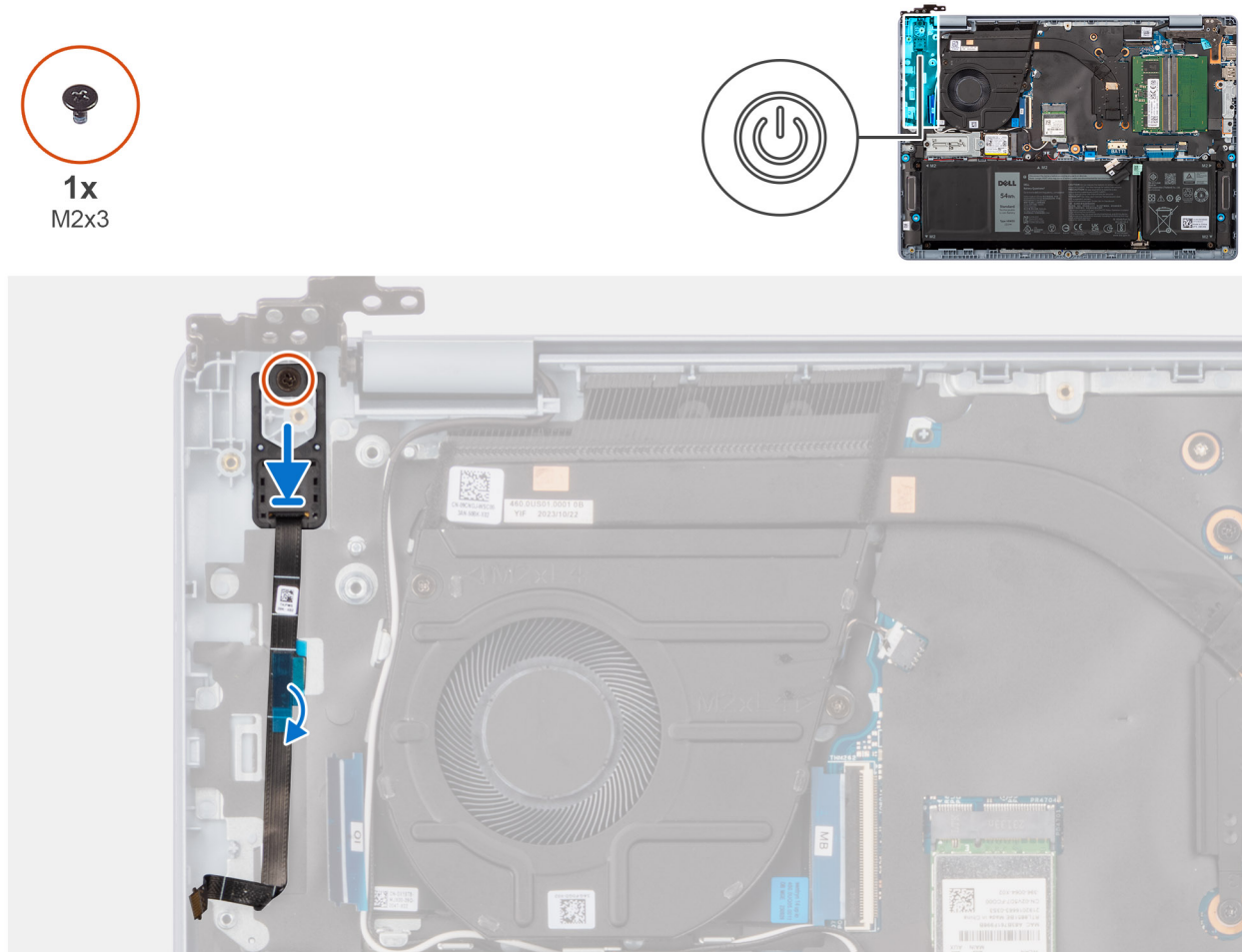

### Steps

1. Place the power-button into its slot on the palm-rest and keyboard assembly.
2. Align the screw hole on the power-button with the screw hole on the palm-rest and keyboard assembly.
3. Replace the screw (M2x3) that secures the power-button to the palm-rest and keyboard assembly.

### Next steps

1. Install the [I/O board for computers shipped with a plastic chassis](#).
2. Install the [base cover for computers shipped with a plastic chassis](#).
3. Follow the procedure in [After working inside your computer](#).

## Removing the power-button with fingerprint reader for computers shipped with an aluminum chassis

**CAUTION:** The information in this section is intended for authorized service technicians only.

## Prerequisites

1. Follow the procedure in [Before working inside your computer](#).

**NOTE:** Ensure that your computer is in Service Mode. For more information see, [Before working inside your computer](#).

2. Remove the [base cover for computers shipped with an aluminum chassis](#).
3. Remove the [I/O board for computers shipped with an aluminum chassis](#).

## About this task

**NOTE:** This procedure is applicable only for computers that are shipped without the optional fingerprint reader.

The following image indicates the location of the power-button and provides a visual representation of the removal procedure.

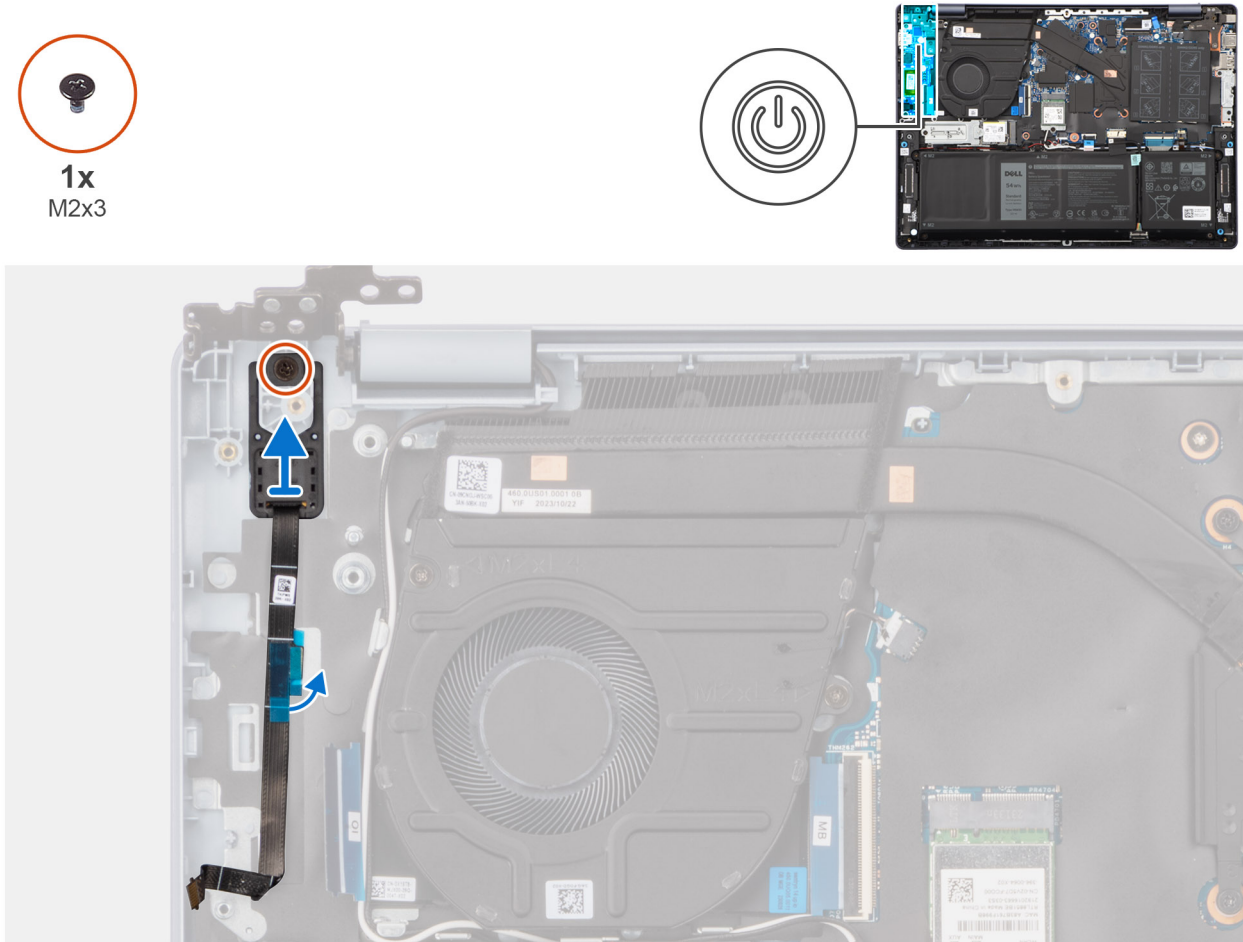

**Figure 56. Removing the power-button with fingerprint reader**

## Steps

1. Remove the screw (M2x3) that secures the power-button to the palm-rest and keyboard assembly.
2. Lift the power-button off the palm-rest and keyboard assembly.

## Installing the power-button with fingerprint reader for computers shipped with an aluminum chassis

**CAUTION:** The information in this section is intended for authorized service technicians only.



## Prerequisites

If you are replacing a component, remove the existing component before performing the installation procedure.

## About this task

**NOTE:** This procedure is applicable only when you are installing a power-button without the optional fingerprint reader.

The following image indicates the location of the power-button with fingerprint reader and provides a visual representation of the installation procedure.

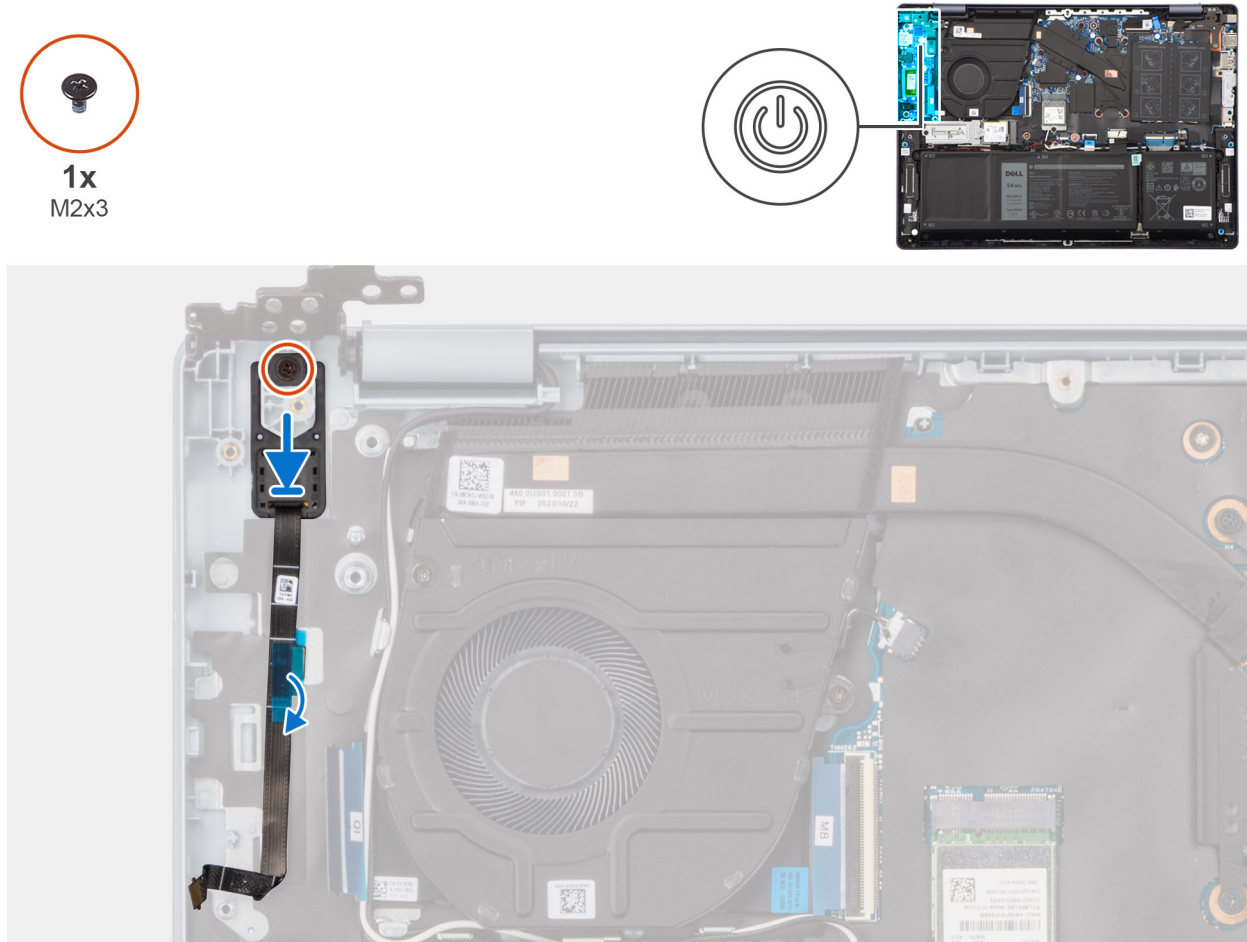

**Figure 57. Installing the power-button with fingerprint reader**

## Steps

1. Place the power-button into its slot on the palm-rest and keyboard assembly.
2. Align the screw hole on the power-button with the screw hole on the palm-rest and keyboard assembly.
3. Replace the screw (M2x3) that secures the power-button to the palm-rest and keyboard assembly.

## Next steps

1. Install the [I/O board for computers shipped with an aluminum chassis](#).
2. Install the [base cover for computers shipped with an aluminum chassis](#).
3. Follow the procedure in [After working inside your computer](#).

# Touchpad

## Removing the touchpad for computers shipped with a plastic chassis

 **CAUTION:** The information in this section is intended for authorized service technicians only.

### Prerequisites

1. Follow the procedure in [Before working inside your computer](#).

 **NOTE:** Ensure that your computer is in Service Mode. For more information see, [Before working inside your computer](#).

2. Remove the [base cover for computers shipped with a plastic chassis](#).
3. Remove the [41 W battery for computers shipped with a plastic chassis](#), or the [54 W battery for computers shipped with a plastic chassis](#).

### About this task

The following image indicates the location of the touchpad and provides a visual representation of the removal procedure.

**Figure 58. Removing the touchpad**

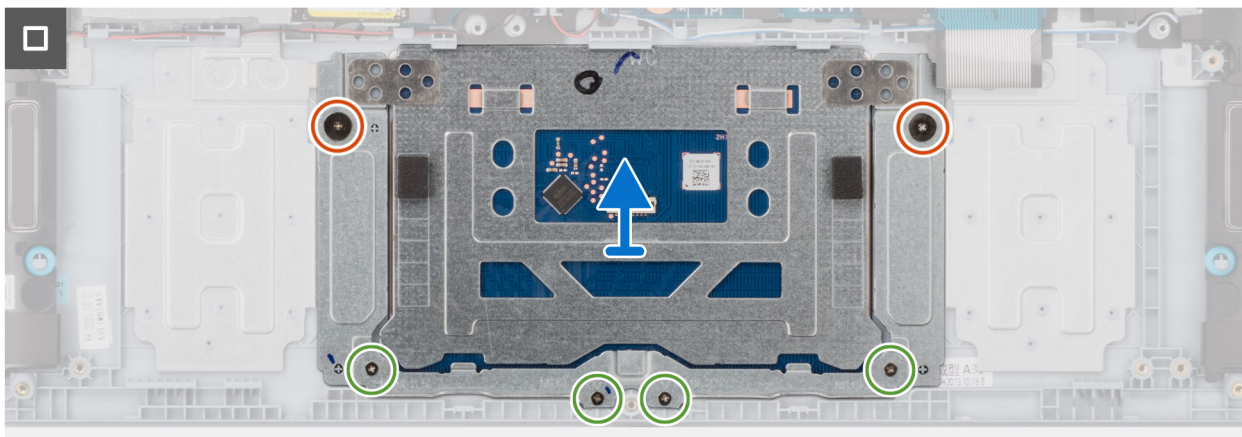
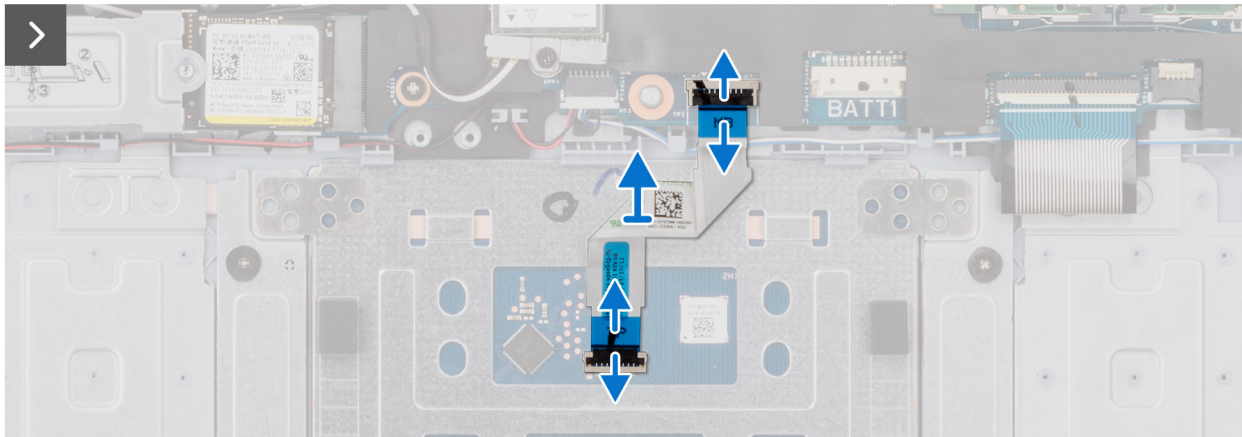
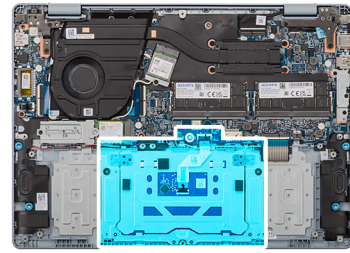
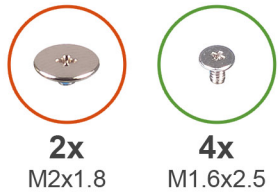

### Steps

1. Open the latch and disconnect the touchpad cable from the connector (TP1) on the system board.
2. Open the latch and disconnect the touchpad cable from the connector on the touchpad.
3. Lift the touchpad cable off the palm-rest and keyboard assembly.
4. Remove the two screws (M2x1.8) and the four screws (M1.6x2.5) that secure the touchpad to the palm-rest and keyboard assembly.
5. Lift the touchpad off the palm-rest and keyboard assembly.

## Installing the touchpad for computers shipped with a plastic chassis

### Prerequisites

If you are replacing a component, remove the existing component before performing the installation process.

### About this task

The following image indicates the location of the touchpad and provides a visual representation of the installation procedure.

**Figure 59. Installing the touchpad**

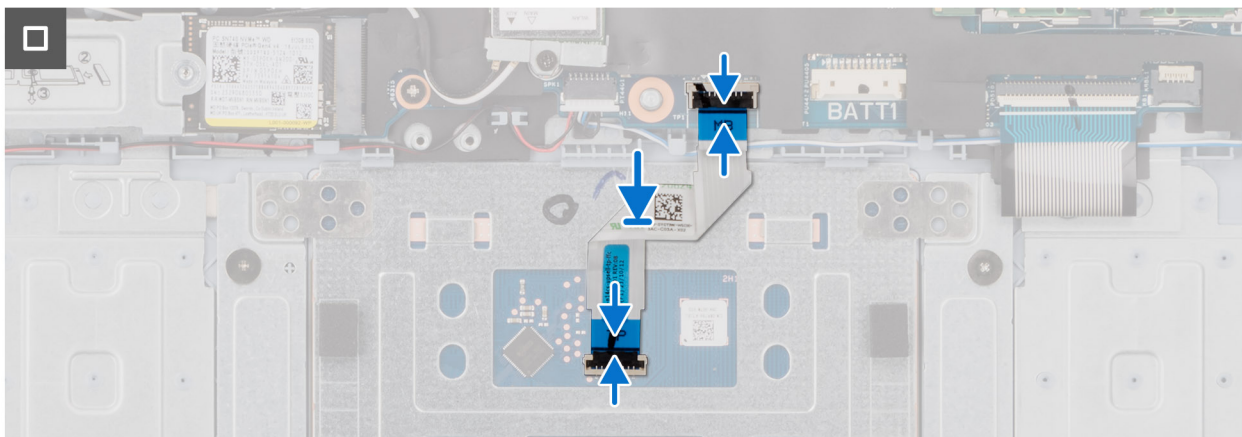
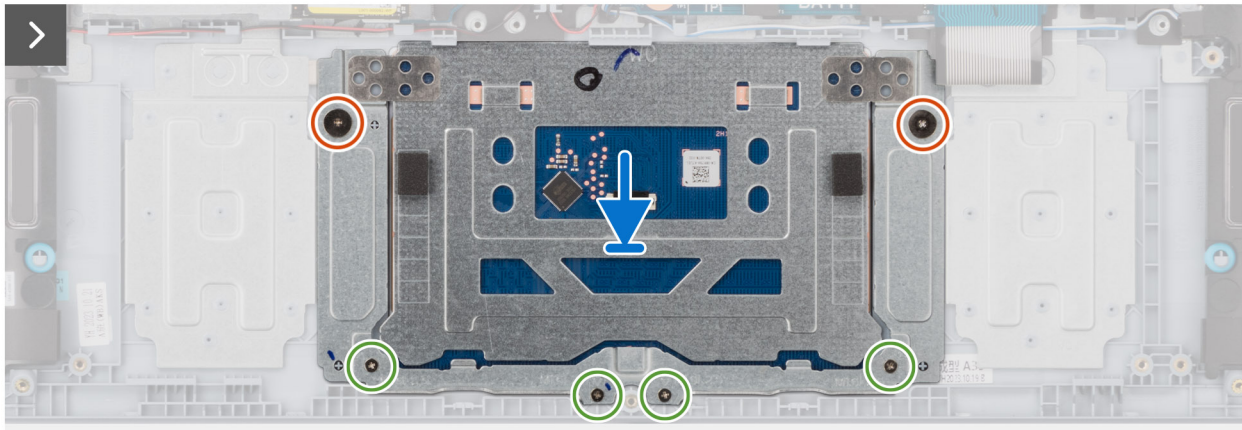
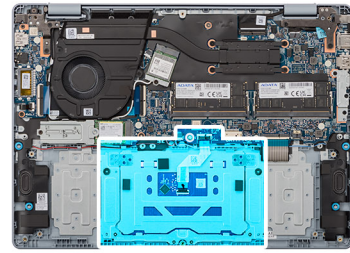
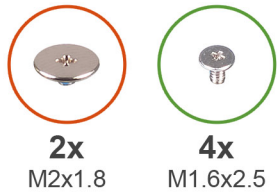

### Steps

1. Place the touchpad into its slot on the palm-rest and keyboard assembly.
2. Align the screw holes on the touchpad with the screw holes on the palm-rest and keyboard assembly.
3. Replace the two screws (M2x1.8) and the four screws (M1.6x2.5) that secure the touchpad to the palm-rest and keyboard assembly.
4. Place the touchpad cable on the palm-rest and keyboard assembly.
5. Connect the touchpad cable to the connector on the touchpad and close the latch.
6. Connect the touchpad cable to the connector (TP1) on the system board and close the latch.

### Next steps

1. Install the [41W battery for computers shipped with a plastic chassis](#), or the [54W battery for computers shipped with a plastic chassis](#).
2. Install the [base cover for computers shipped with a plastic chassis](#).
3. Follow the procedure in [After working inside your computer](#).

# Removing the touchpad for computers shipped with an aluminum chassis

**CAUTION:** The information in this section is intended for authorized service technicians only.

## Prerequisites

1. Follow the procedure in [Before working inside your computer](#).

**NOTE:** Ensure that your computer is in Service Mode. For more information see, [Before working inside your computer](#).

2. Remove the [base cover](#) for computers shipped with an aluminum chassis.
3. Remove the [54W battery](#) for computers shipped with an aluminum chassis.

## About this task

The following image indicates the location of the touchpad and provides a visual representation of the removal procedure.

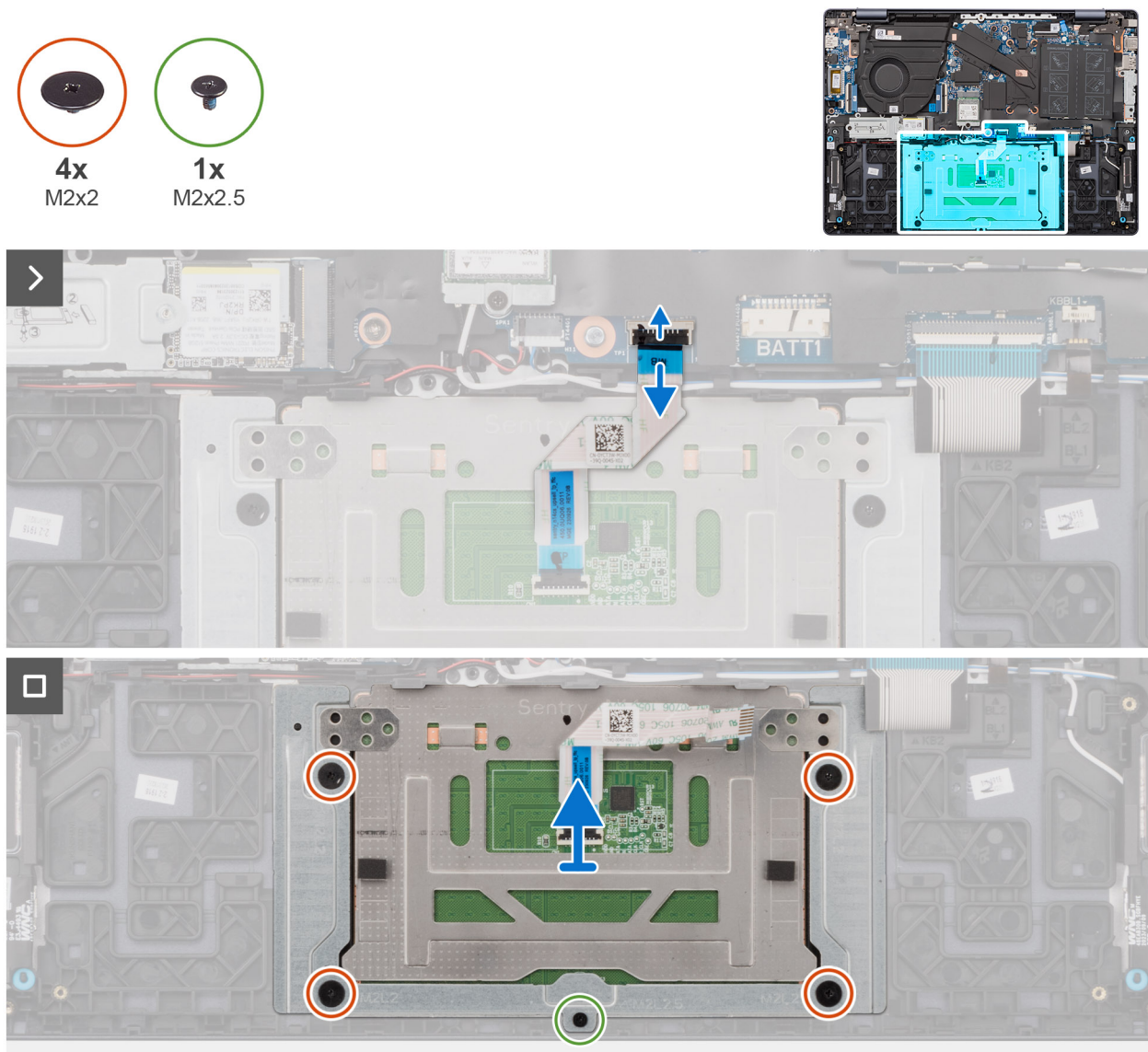

Figure 60. Removing the touchpad

## Steps

1. Open the latch and disconnect the touchpad cable from the connector (TP1) on the system board.
2. Open the latch and disconnect the touchpad cable from the connector on the touchpad.
3. Lift the touchpad cable off the palm-rest and keyboard assembly.
4. Remove the screw (M2x2.5) and the four screws (M2x2) that secure the touchpad to the palm-rest and keyboard assembly.
5. Lift the touchpad off the palm-rest and keyboard assembly.

## Installing the touchpad for computers shipped with an aluminum chassis

### Prerequisites

If you are replacing a component, remove the existing component before performing the installation process.

### About this task

The following image indicates the location of the touchpad and provides a visual representation of the installation procedure.

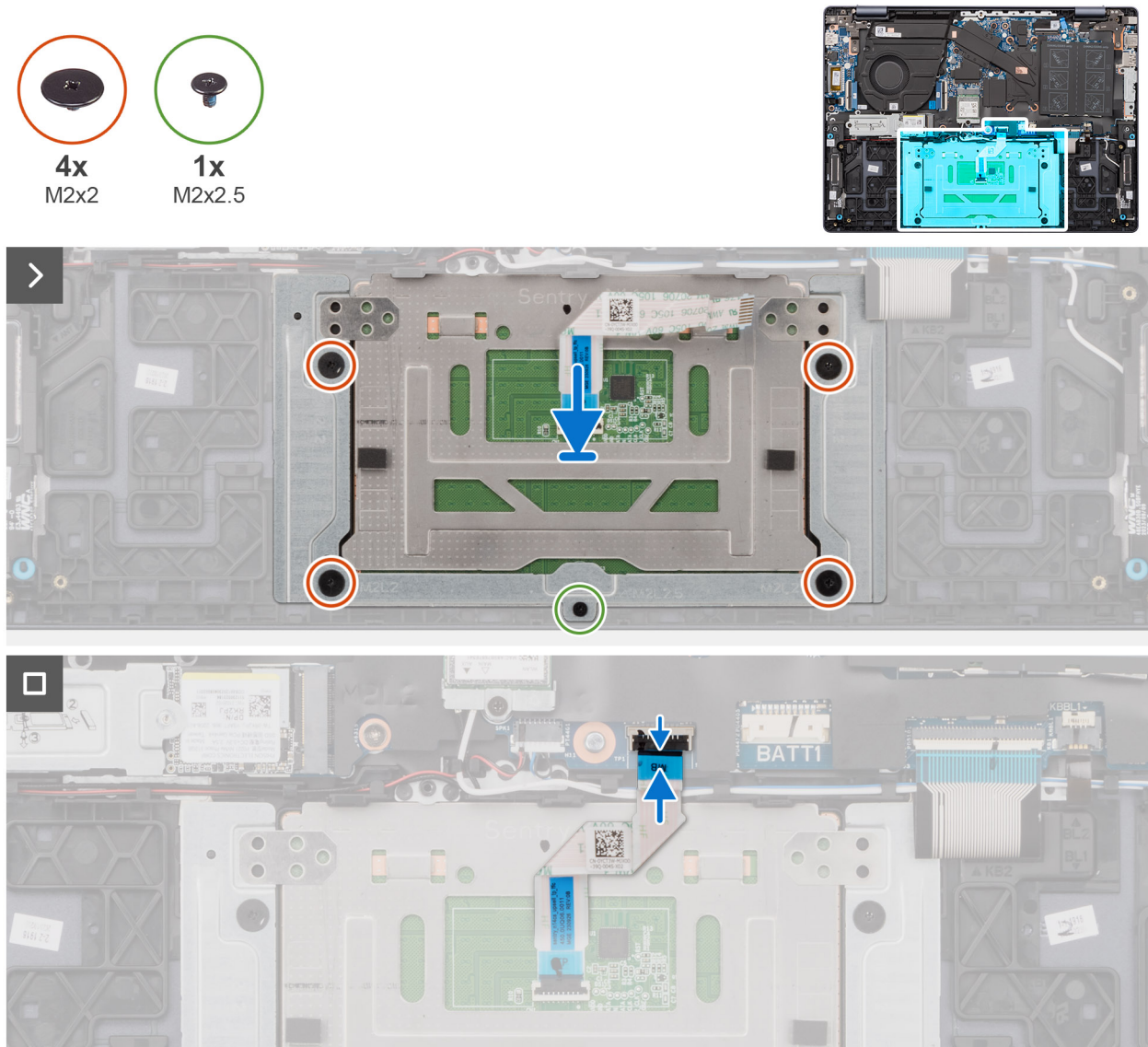

Figure 61. Installing the touchpad

### Steps

1. Place the touchpad into its slot on the palm-rest and keyboard assembly.
2. Align the screw holes on the touchpad with the screw holes on the palm-rest and keyboard assembly.
3. Replace the single screw (M2x2.5) and the four screws (M2x2) that secure the touchpad to the palm-rest and keyboard assembly.
4. Place the touchpad cable on the palm-rest and keyboard assembly.
5. Connect the touchpad cable to the connector on the touchpad and close the latch.
6. Connect the touchpad cable to the connector (TP1) on the system board and close the latch.

### Next steps

1. Install the [54W battery for computers shipped with an aluminum chassis](#).
2. Install the [base cover for computers shipped with an aluminum chassis](#).
3. Follow the procedure in [After working inside your computer](#).

## Speakers

### Removing the speakers for computers shipped with a plastic chassis

 **NOTE:** The information in this section is intended for authorized service technicians only.

#### Prerequisites

1. Follow the procedure in [Before working inside your computer](#).

 **NOTE:** Ensure that your computer is in Service Mode. For more information see, [Before working inside your computer](#).

2. Remove the [base cover for computers shipped with a plastic chassis](#).
3. Remove the [41 W battery for computers shipped with a plastic chassis](#), or the [54 W battery for computers shipped with a plastic chassis](#).

#### About this task

The following image indicates the location of the speakers and provides a visual representation of the removal procedure.

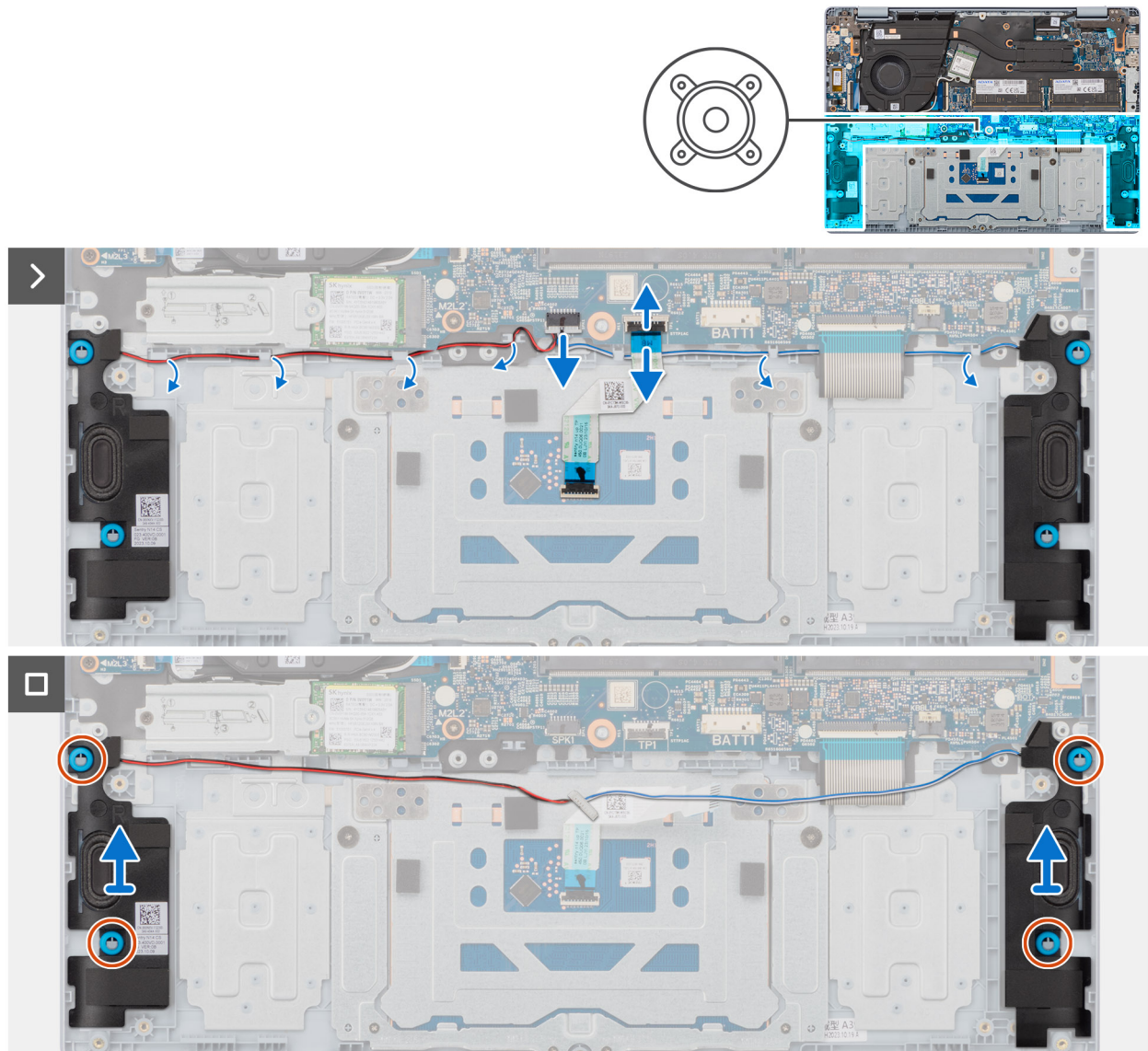

**Figure 62. Removing the speakers**

### Steps

1. Open the latch and disconnect the keyboard-backlight cable from the connector (KBBL1) on the system board.
2. Open the latch and disconnect the keyboard cable from the connector (KB1) on the system board.
3. Open the latch and disconnect the touchpad cable from the connector (TP1) on the system board.
4. Disconnect the speaker cable from the connector (SPK1) on the system board.
5. Remove the speaker from the routing guides on the palm-rest and keyboard assembly.
6. Lift the left and right speakers along with the cables, off the palm-rest and keyboard assembly.

## Installing the speakers for computers shipped with a plastic chassis

**CAUTION:** The information in this section is intended for authorized service technicians only.

### Prerequisites

If you are replacing a component, remove the existing component before performing the installation procedure.



## About this task

The following image indicates the location of the speakers and provides a visual representation of the installation procedure.

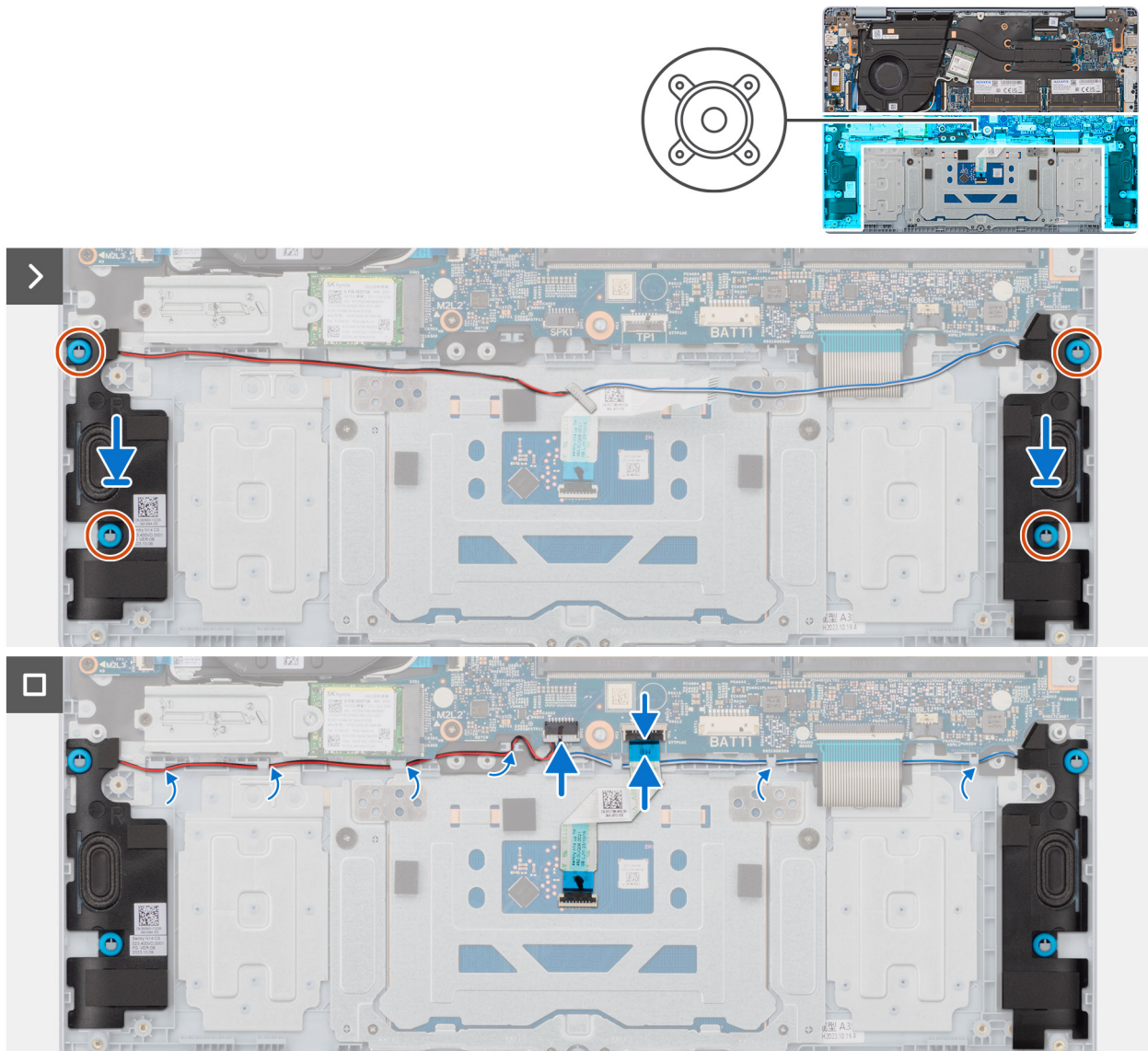

**Figure 63. Installing the speakers**

## Steps

1. Using the alignment posts and rubber grommets, place the speakers on the slots of the palm-rest and keyboard assembly.  
**i** **NOTE:** Ensure that the rubber grommets on the speakers are threaded through the alignment posts and the four rubber grommets are seated into the slot and installed on the speakers properly .
2. Route the speaker cables through the routing guides on the palm-rest and keyboard assembly.  
**i** **NOTE:** Ensure the wires of the speakers and wireless antennas are placed in their routing guides accordingly.
3. Connect the speaker cable to the connector (SPK1) on the system board.
4. Connect the touchpad cable to the connector (TP1) on the system board and close the latch.
5. Connect the keyboard cable to the connector (KB1) on the system board and close the latch.
6. Connect the keyboard-backlight cable to the connector (KBBL1) on the system board and close the latch.

### Next steps

1. Install the [41W battery](#) for computers shipped with a plastic chassis, or the [54W battery](#) for computers shipped with a plastic chassis.
2. Install the [base cover](#) for computers shipped with a plastic chassis.
3. Follow the procedure in [After working inside your computer](#).

## Removing the speakers for computers shipped with an aluminum chassis

 **NOTE:** The information in this section is intended for authorized service technicians only.

### Prerequisites

1. Follow the procedure in [Before working inside your computer](#).

 **NOTE:** Ensure that your computer is in Service Mode. For more information see, [Before working inside your computer](#).

2. Remove the [base cover](#) for computers shipped with an aluminum chassis.
3. Remove the [54W battery](#) for computers shipped with an aluminum chassis.
4. Remove the [wireless card](#) for computers shipped with an aluminum chassis.

### About this task

The following image indicates the location of the speakers and provides a visual representation of the removal procedure.

#### Figure 64. Removing the speakers

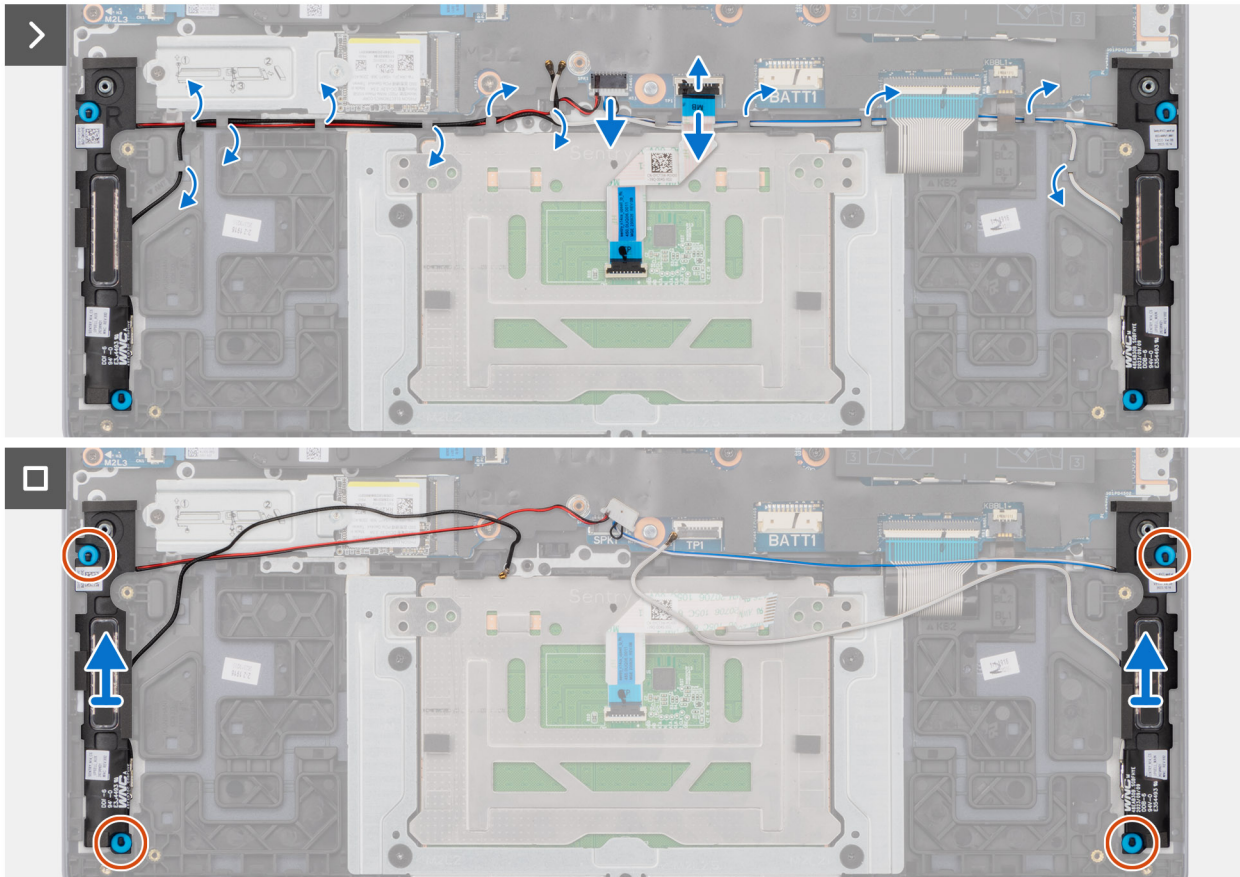
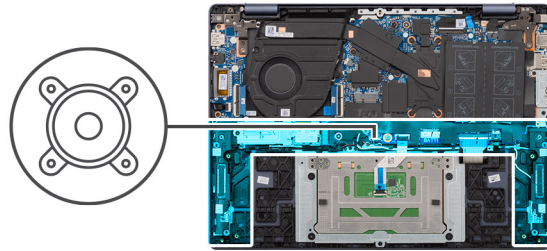

### Steps

1. Open the latch and disconnect the keyboard-backlight cable from the connector (KBBL1) on the system board.
2. Open the latch and disconnect the keyboard cable from the connector (KB1) on the system board.
3. Open the latch and disconnect the touchpad cable from the connector (TP1) on the system board.
4. Disconnect the speaker cable from the connector (SPK1) on the system board.
5. Remove the speaker and wireless antenna module cables and from the routing guides on the palm-rest and keyboard assembly.
6. Lift the left and right speakers along with the cables, off the palm-rest and keyboard assembly.

## Installing the speakers for computers shipped with an aluminum chassis

**CAUTION:** The information in this section is intended for authorized service technicians only.

### Prerequisites

If you are replacing a component, remove the existing component before performing the installation procedure.

## About this task

The following image indicates the location of the speakers and provides a visual representation of the installation procedure.

**Figure 65. Installing the speakers**

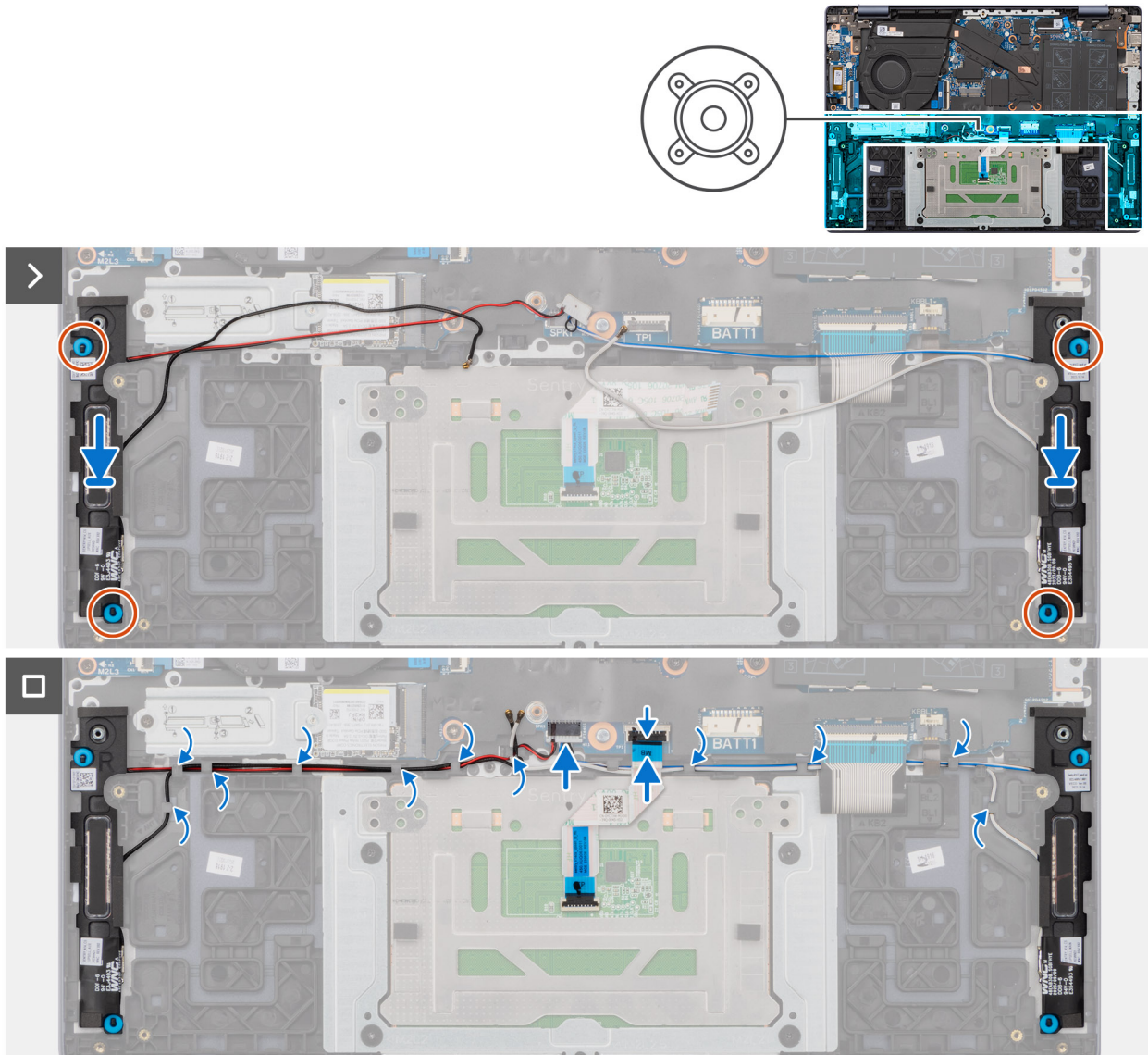

## Steps

1. Using the alignment posts and rubber grommets, place the speakers on the slots of the palm-rest and keyboard assembly.  
**i** **NOTE:** Ensure that the rubber grommets on the speakers are threaded through the alignment posts and the four rubber grommets are seated into the slot and installed on the speakers properly .
2. Route the speaker and wireless antenna module cables through the routing guides on the palm-rest and keyboard assembly.  
**i** **NOTE:** Ensure the wires of the speakers and wireless antennas are placed in their routing guides accordingly.
3. Connect the speaker cable to the connector (SPK1) on the system board.
4. Connect the touchpad cable to the connector (TP1) on the system board and close the latch.
5. Connect the keyboard cable to the connector (KB1) on the system board and close the latch.
6. Connect the keyboard-backlight cable to the connector (KBBL1) on the system board and close the latch.

### Next steps

1. Install the [wireless card](#) for computers shipped with an aluminum chassis.
2. Install the [54 W battery](#) for computers shipped with an aluminum chassis.
3. Install the [base cover](#) for computers shipped with an aluminum chassis.
4. Follow the procedure in [After working inside your computer](#).

## Display assembly

### Removing the display assembly for computers shipped with a plastic chassis

 **CAUTION:** The information in this section is intended for authorized service technicians only.

#### Prerequisites

1. Follow the procedure in [Before working inside your computer](#).

 **NOTE:** Ensure that your computer is in Service Mode. For more information see, [Before working inside your computer](#).

2. Remove the [base cover](#) for computers shipped with a plastic chassis.

#### About this task

The following images indicate the location of the display assembly and provide a visual representation of the removal procedure.

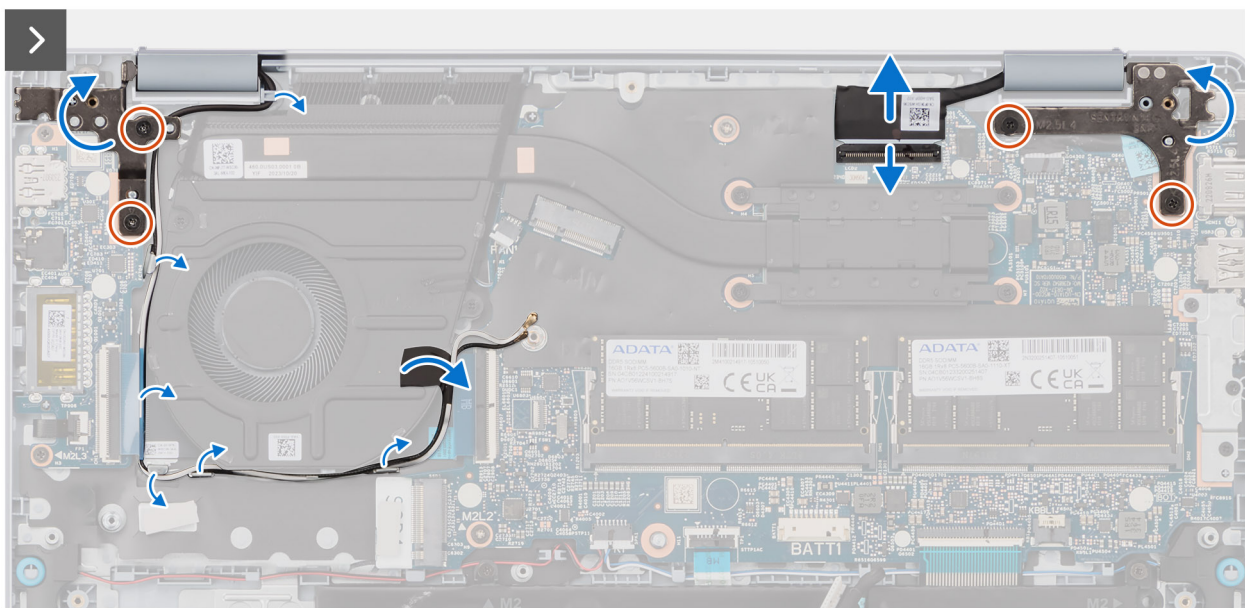
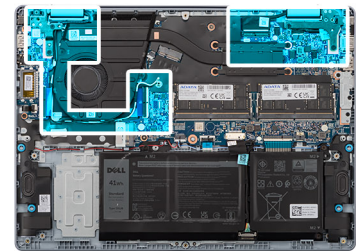
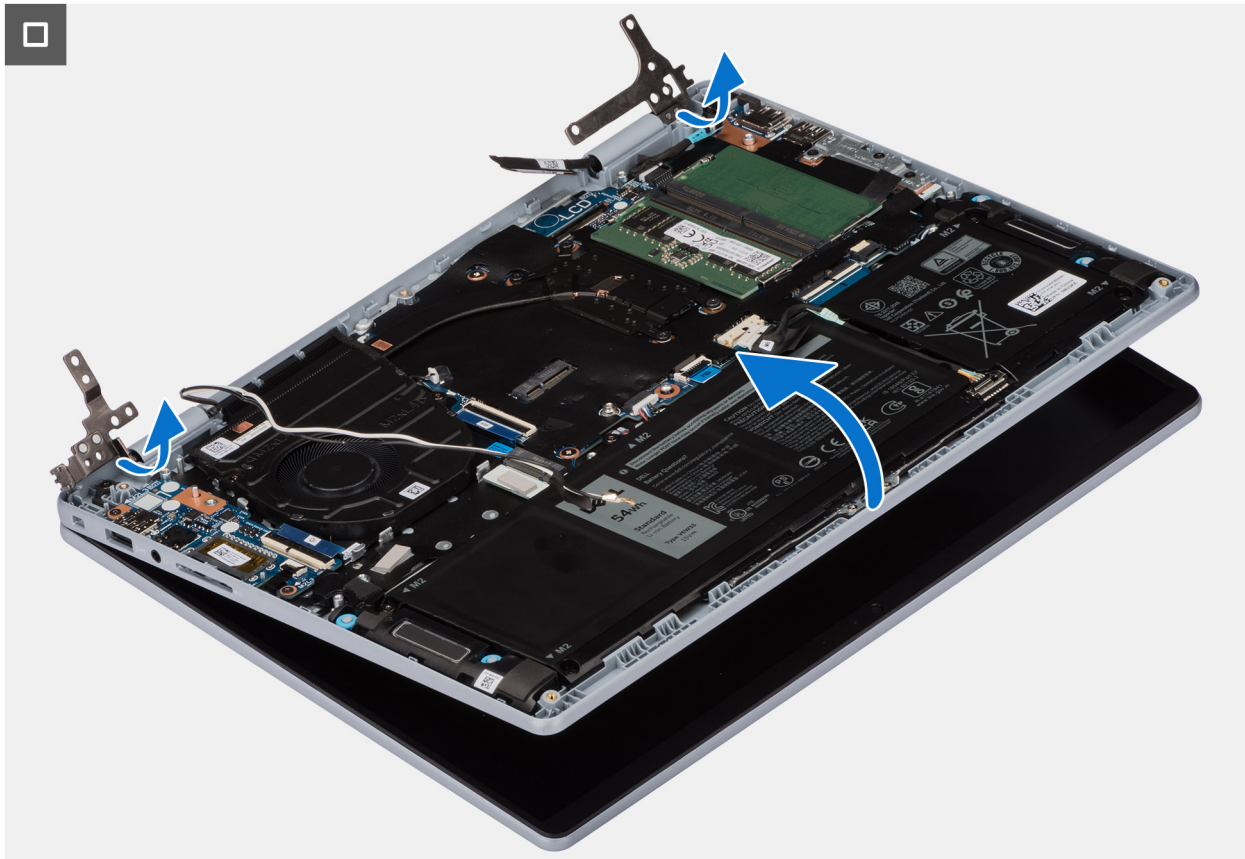

Figure 66. Removing the screws



**Figure 67. Removing the display assembly**

### Steps

1. Remove the two screws (M2.5x4) that secure the left display hinge to the palm-rest and keyboard assembly.
2. Remove the two screws (M2.5x4) that secure the right display hinge to the palm-rest and keyboard assembly.
3. Open the hinges to a 90-degree angle and place the computer on the edge of a flat surface.
4. Peel the tape that secures the display-cable connector latch to the system board.
5. Open the latch and disconnect the display cable from the connector on the system board.
6. Peel the tape that secures the wireless antenna cables to the system board.
7. Unroute the wireless antenna cables from the routing guides of the palm-rest and keyboard assembly.
8. Gently lift the palm-rest and keyboard assembly off the display assembly.

## Installing the display assembly for computers shipped with a plastic chassis

**CAUTION:** The information in this section is intended for authorized service technicians only.

### Prerequisites

If you are replacing a component, remove the existing component before performing the installation process.

### About this task

The following images indicate the location of the display assembly and provide a visual representation of the installation procedure.



4x  
M2.5x4

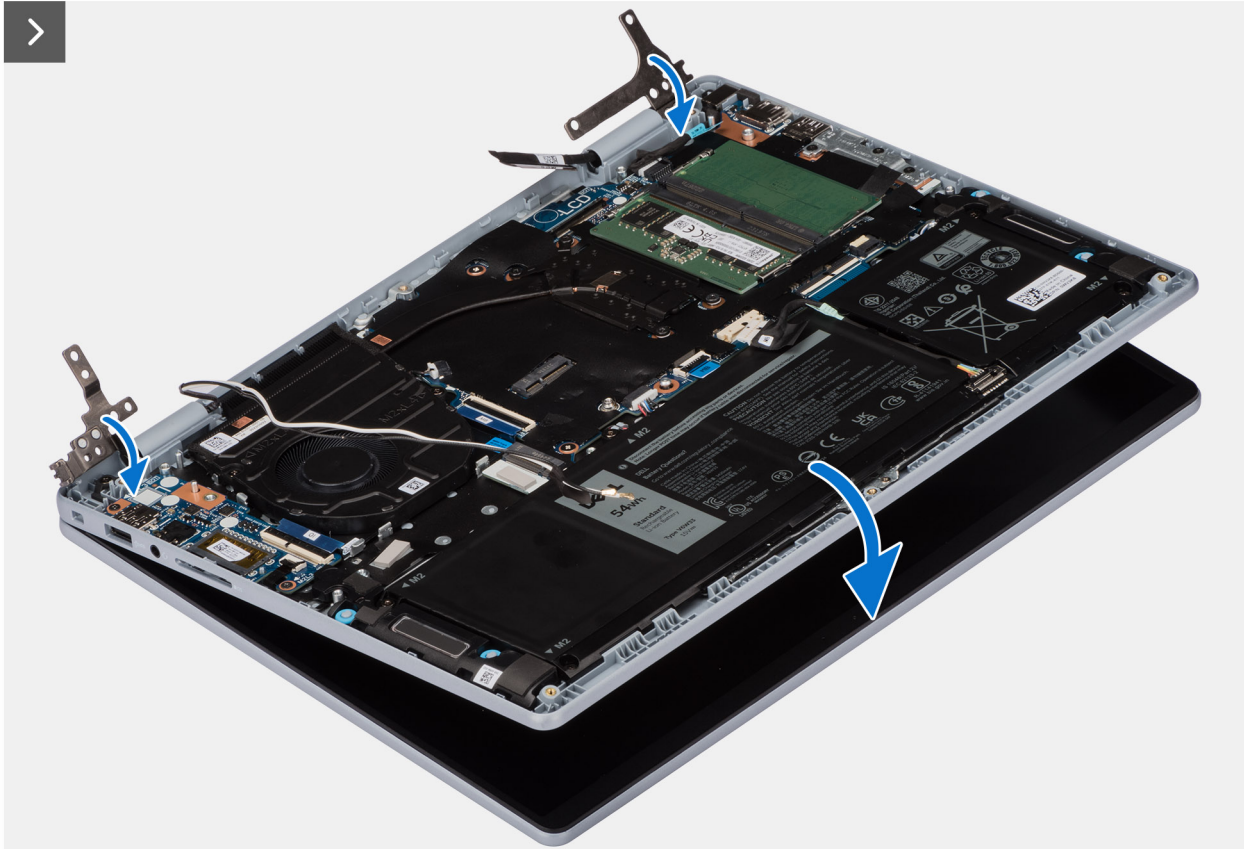
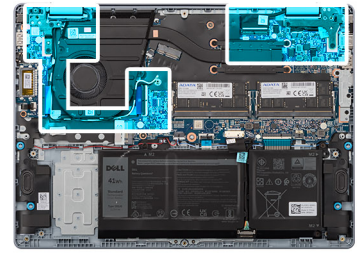
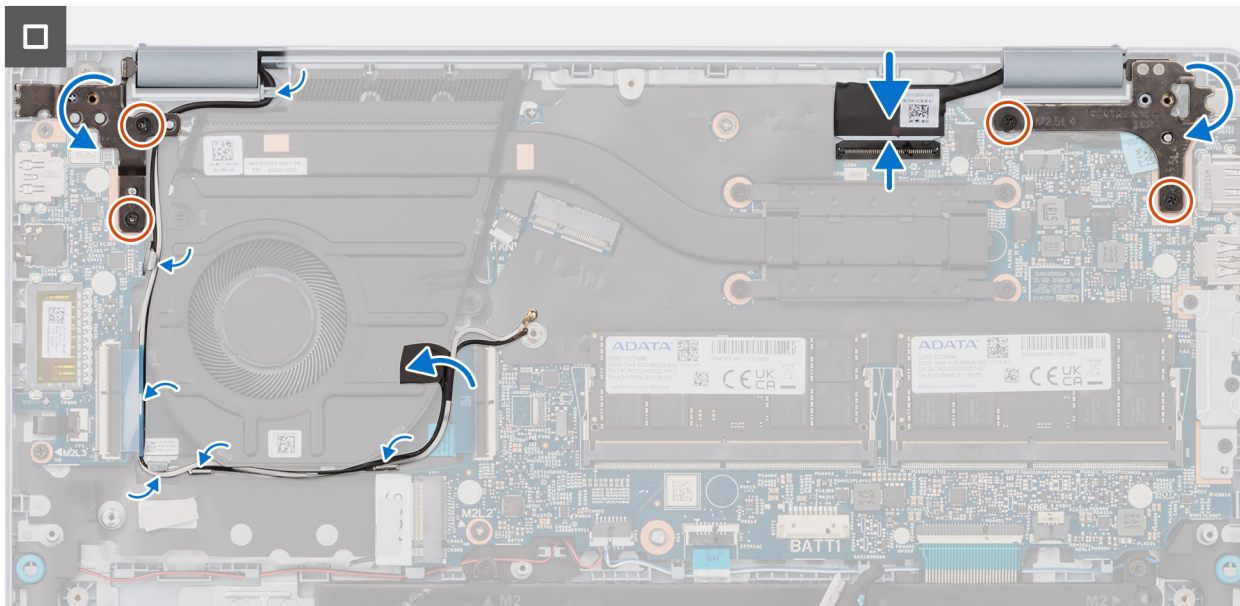

Figure 68. Installing the display assembly

Figure 69. Replacing the screws



### Steps

1. Place the display assembly on a clean and flat surface.
2. Place the palm-rest and keyboard assembly on the display assembly.
3. Rotate to close the left and right hinges.
4. Align the screw holes on the display hinges with the screw holes on the palm-rest and keyboard assembly.
5. Replace the two screws (M2.5x4) that secure the left display hinge to the palm-rest and keyboard assembly.
6. Replace the two screws (M2.5x4) that secure the right display hinge to the palm-rest and keyboard assembly.
7. Connect the display cable to the connector on the system board and close the latch.
8. Adhere the tape that secures the display-cable connector latch to the system board.
9. Route the wireless antenna cables through the routing guides on the palm-rest and keyboard assembly.
10. Adhere the tape that secures the wireless antenna cables to the system board.

### Next steps

1. Install the [base cover for computer shipped with a plastic chassis](#).
2. Follow the procedure in [After working inside your computer](#).

## Removing the display assembly for computers shipped with an aluminum chassis

**CAUTION:** The information in this section is intended for authorized service technicians only.

### Prerequisites

1. Follow the procedure in [Before working inside your computer](#).

**NOTE:** Ensure that your computer is in Service Mode. For more information see, [Before working inside your computer](#).

2. Remove the [base cover for computers shipped with an aluminum chassis](#).

### About this task

The following images indicate the location of the display assembly and provide a visual representation of the removal procedure.





4x  
M2.5x4.5

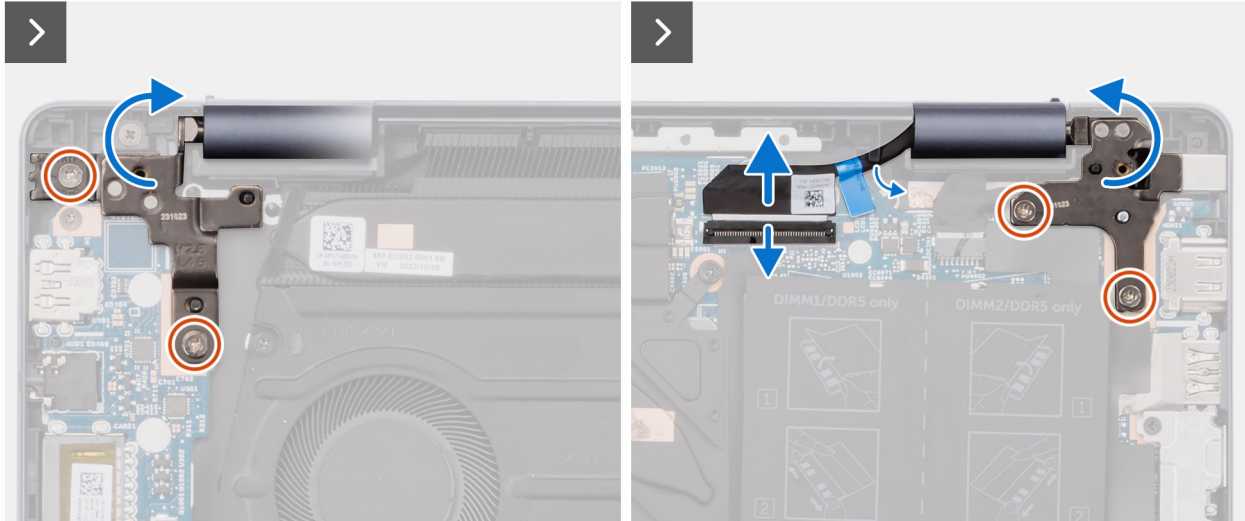
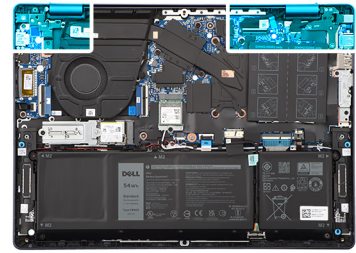

Figure 70. Removing the screws

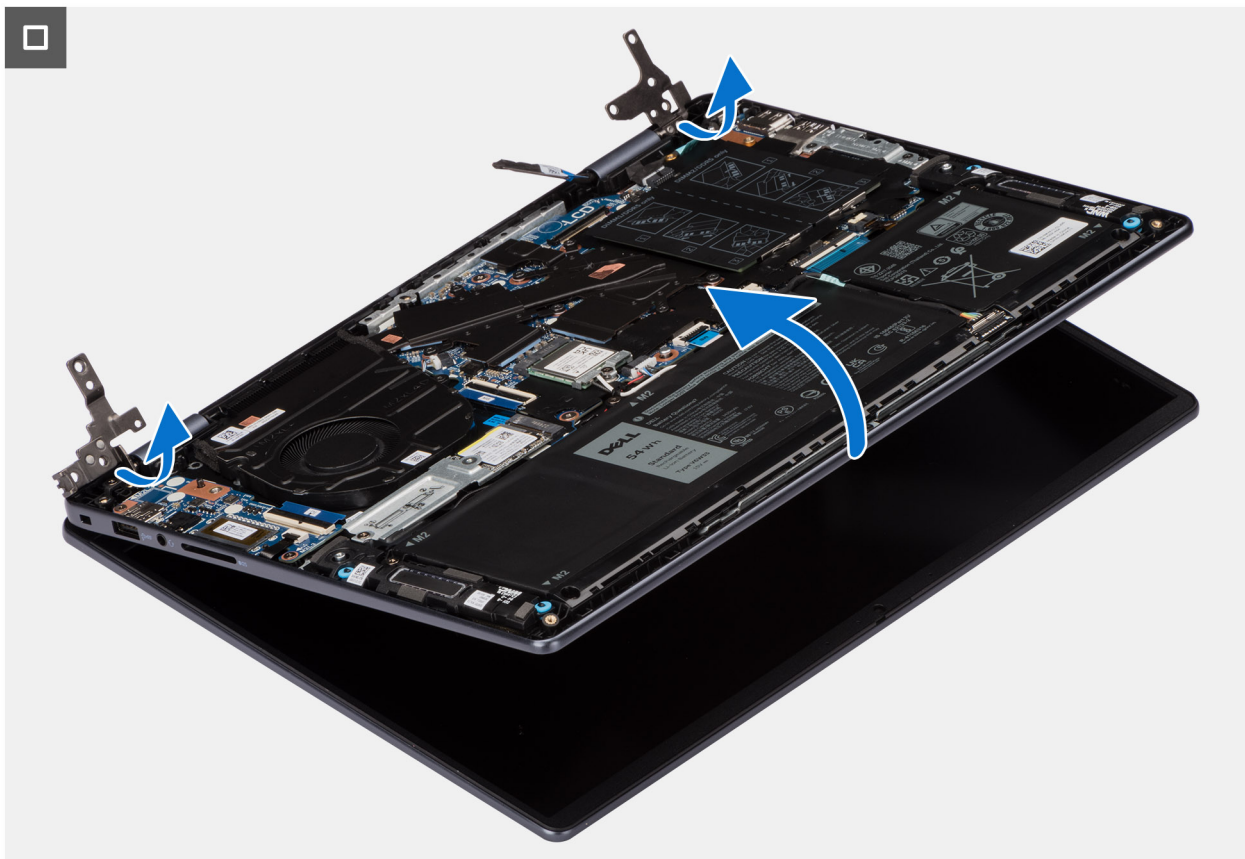

Figure 71. Removing the display assembly

### Steps

1. Remove the two screws (M2.5x4.5) that secure the left display hinge to the palm-rest and keyboard assembly.
2. Remove the two screws (M2.5x4.5) that secure the right display hinge to the palm-rest and keyboard assembly.
3. Open the hinges to a 90-degree and place the computer on the edge of a flat surface..



**NOTE:** The display assembly is a Hinge-Up Design (HUD) assembly and cannot be further disassembled. If any components in the display assembly malfunction and requires replacement, the entire display assembly has to be replaced.

4. Peel the tape that secures the display-cable connector latch to the system board.
5. Open the latch and disconnect the display cable from the connector on the system board.
6. Peel the tape that secures the wireless antenna cables to the system board.
7. Unroute the wireless antenna cables from the routing guides of the palm-rest and keyboard assembly.
8. Gently lift the palm-rest and keyboard assembly off the display assembly.

## Installing the display assembly for computers shipped with an aluminum chassis



**CAUTION:** The information in this section is intended for authorized service technicians only.

### Prerequisites

If you are replacing a component, remove the existing component before performing the installation process.

### About this task

The following images indicate the location of the display assembly and provide a visual representation of the installation procedure.



4x  
M2.5x4.5

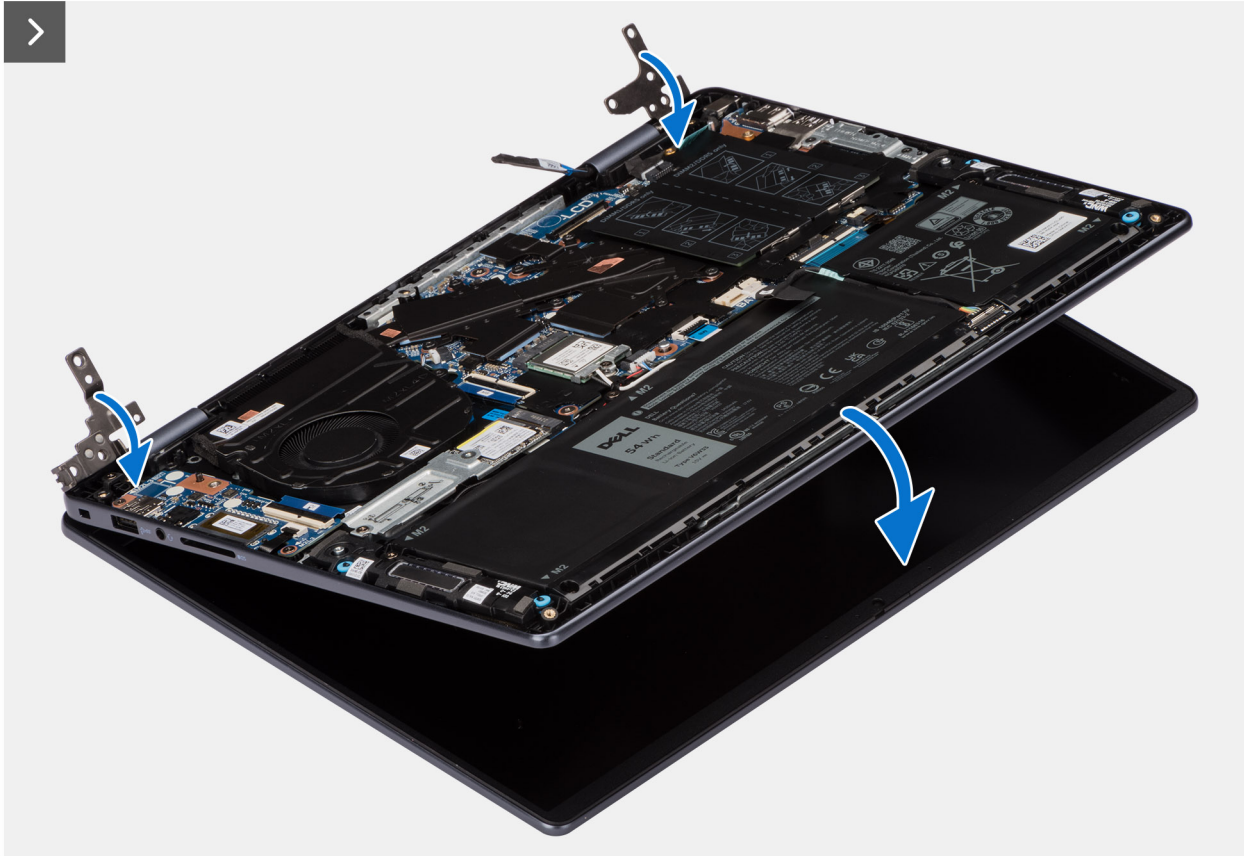
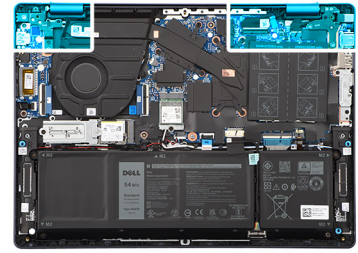

Figure 72. Installing the display assembly

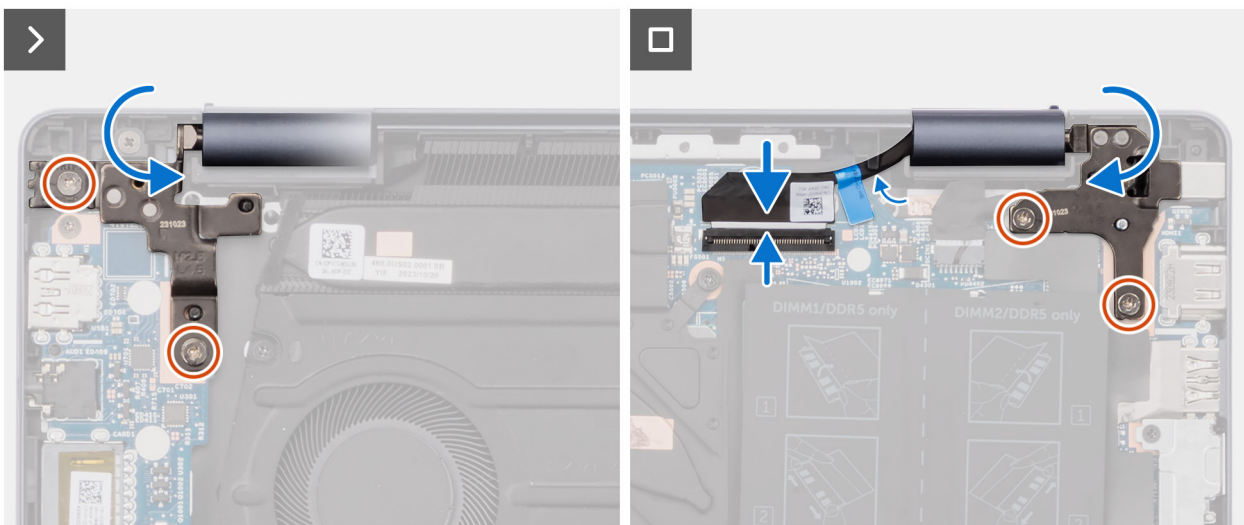

Figure 73. Replacing the screws

### Steps

1. Place the display assembly on a clean and flat surface.
2. Place the palm-rest and keyboard assembly on the display assembly.
3. Rotate to close the left and right hinges.
4. Align the screw holes on the display hinges with the screw holes on the palm-rest and keyboard assembly.
5. Replace the two screws (M2.5x4.5) that secure the left display hinge to the palm-rest and keyboard assembly.
6. Replace the two screws (M2.5x4.5) that secure the right display hinge to the palm-rest and keyboard assembly.
7. Connect the display cable to the connector on the system board and close the latch.
8. Adhere the tape that secures the display-cable connector latch to the system board.

### Next steps

1. Install the [base cover for computers shipped with an aluminum chassis](#).
2. Follow the procedure in [After working inside your computer](#).

## Display bezel

### Removing the display bezel for computers shipped with a plastic chassis

 **CAUTION:** The information in this removal section is intended for authorized service technicians only.

### Prerequisites

1. Follow the procedure in [Before working inside your computer](#).
2. Remove the [base cover for computers shipped with a plastic chassis](#).
3. Remove the [M.2 2230 solid-state drive for computers shipped with a plastic chassis](#).
4. Remove the [wireless card for computers shipped with a plastic chassis](#).
5. Remove the [display assembly for computers shipped with a plastic chassis](#).

### About this task

 **NOTE:** The display-hinge caps are a part of the display bezel.

The following image indicates the location of the display bezel and provides a visual representation of the removal procedure.

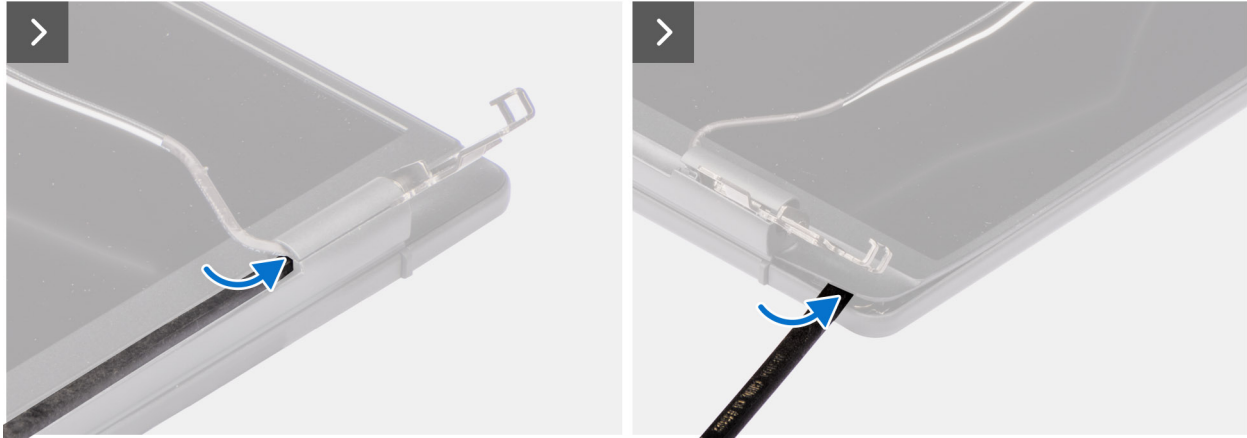

**Figure 74. Removing the display bezel**

**Steps**

1. Place the display assembly on a clean, flat surface and gently open the display hinges to at least 90 degrees.
2. Using a plastic scribe, pry open the left display-hinge cap from its right side and pry open the right display-hinge cap from its left side.
3. Carefully pry open the outer edge of the bottom side of the display bezel.
4. Using the plastic scribe, pry open the outside edge of the left, right, and top sides of the display bezel.

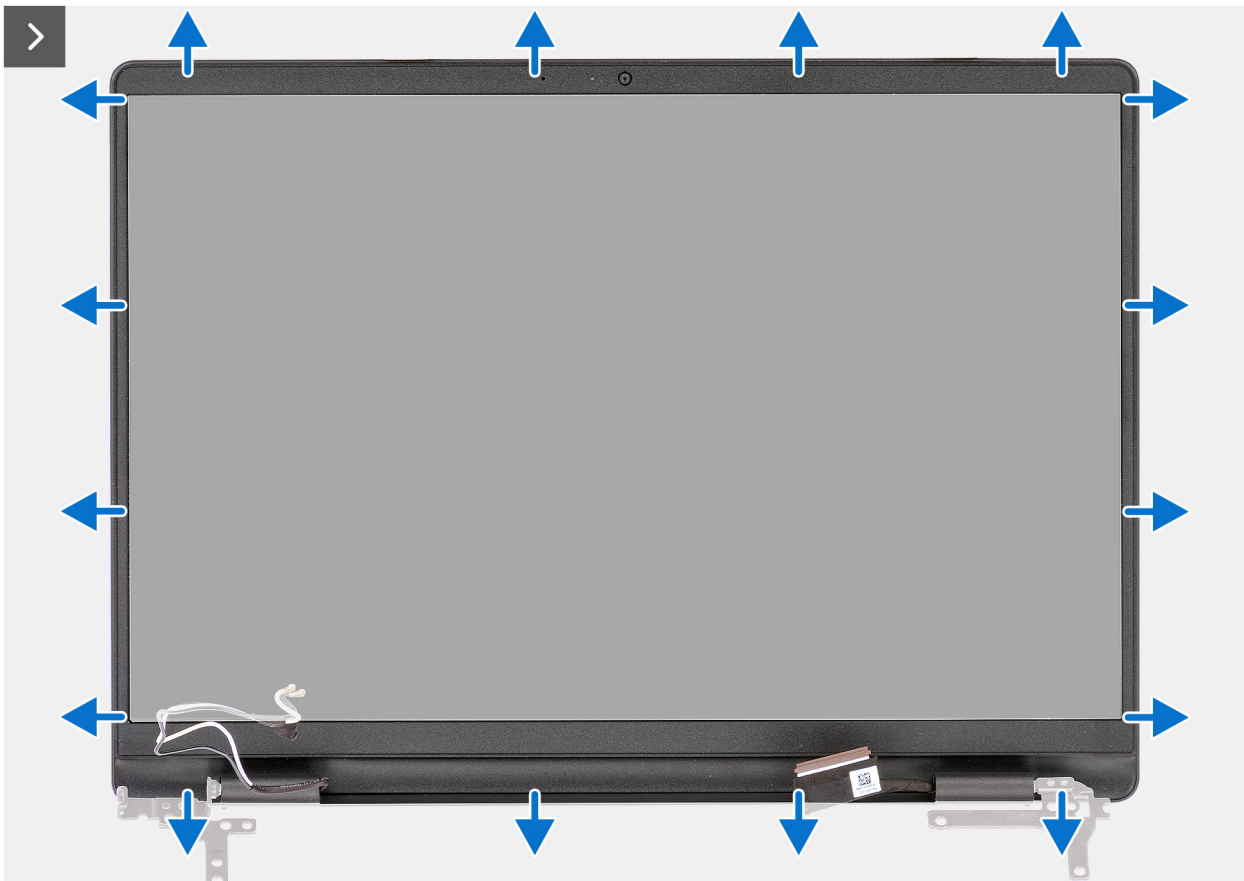

5. Lift and remove the display bezel from the display assembly.

## Installing the display bezel for computers shipped with a plastic chassis

 **CAUTION:** The information in this installation section is intended for authorized service technicians only.

### Prerequisites

If you are replacing a component, remove the existing component before performing the installation procedure.

### About this task

 **NOTE:** The display-hinge caps are a part of the display bezel.

The following image indicates the location of the display bezel and provides a visual representation of the installation procedure.

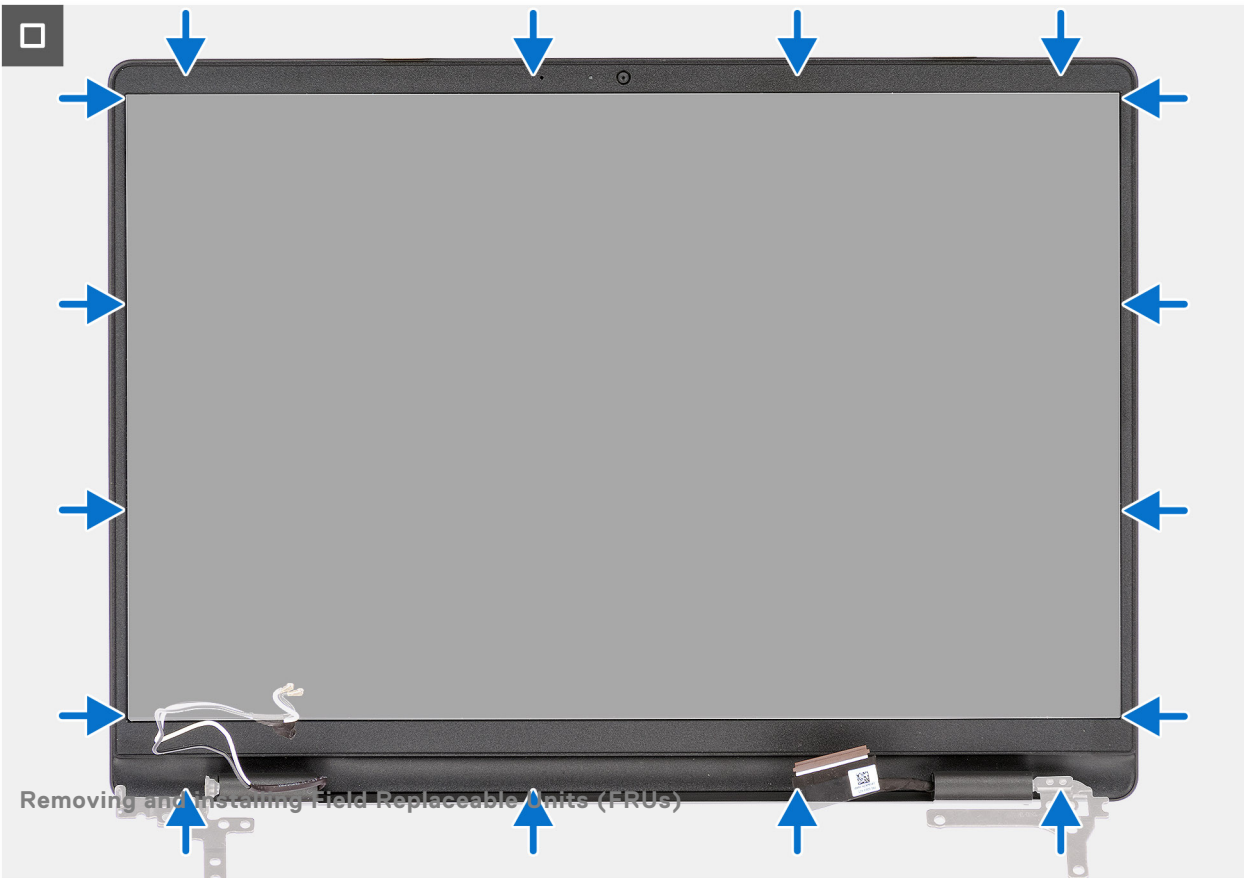
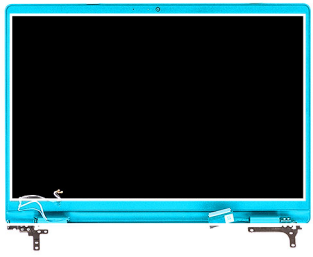



### Steps

1. Place the display assembly on a clean and flat surface.
2. Align and place the display bezel on the display assembly.
3. Starting from the top corner, press on the display bezel and work around the entire bezel until it clicks onto the display assembly.
4. Press the display-hinge caps down on the display hinges, until they click in place.

### Next steps

1. Install the [display assembly for computers shipped with a plastic chassis](#).
2. Install the [wireless card for computers shipped with a plastic chassis](#).
3. Install the [M.2 2230 solid-state drive for computers shipped with a plastic chassis](#).
4. Install the [base cover for computers shipped with a plastic chassis](#).
5. Follow the procedure in [After working inside your computer](#).

## Display panel

### Removing the display panel for computers shipped with a plastic chassis

 **CAUTION:** The information in this removal section is intended for authorized service technicians only.

### Prerequisites

1. Follow the procedure in [Before working inside your computer](#).
2. Remove the [base cover for computers shipped with a plastic chassis](#).
3. Remove the [M.2 2230 solid-state drive for computers shipped with a plastic chassis](#).
4. Remove the [wireless card for computers shipped with a plastic chassis](#).
5. Remove the [display assembly for computers shipped with a plastic chassis](#).
6. Remove the [display bezel for computers shipped with a plastic chassis](#).

### About this task

 **NOTE:** The display panel is assembled with the display brackets and display hinges as a single service part.

The following images indicate the location of the display panel and provide a visual representation of the removal procedure.



**6x**  
M2.5x2.5

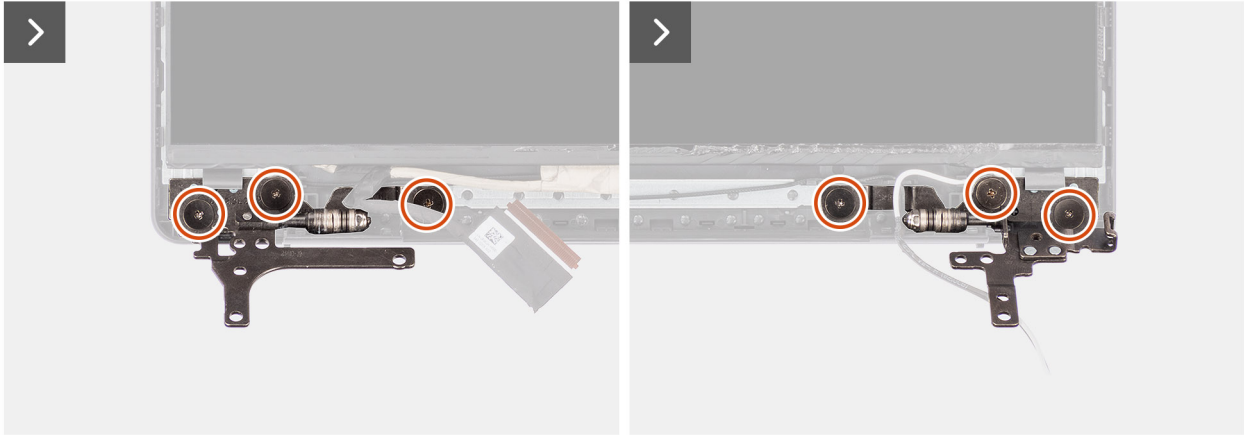

Figure 76. Removing the display panel screws

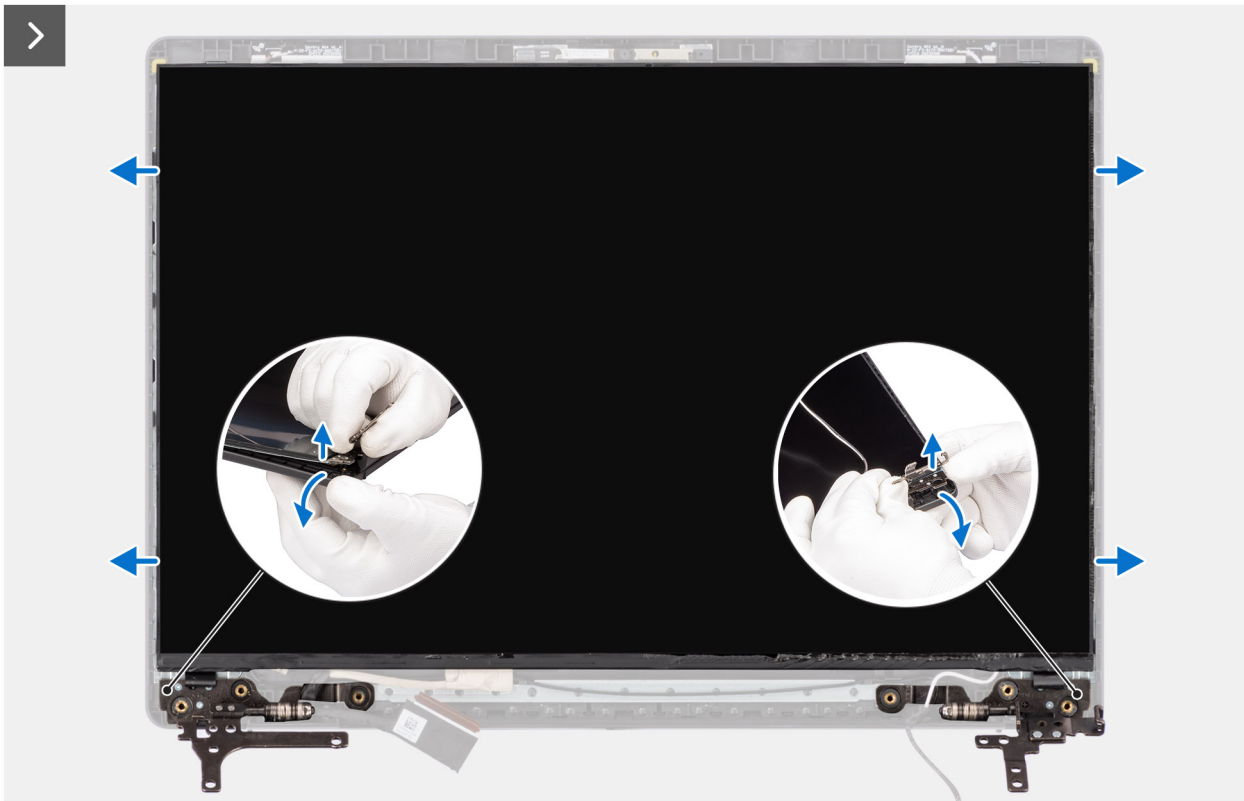

Figure 77. Removing the display panel



Figure 78. Removing the display panel

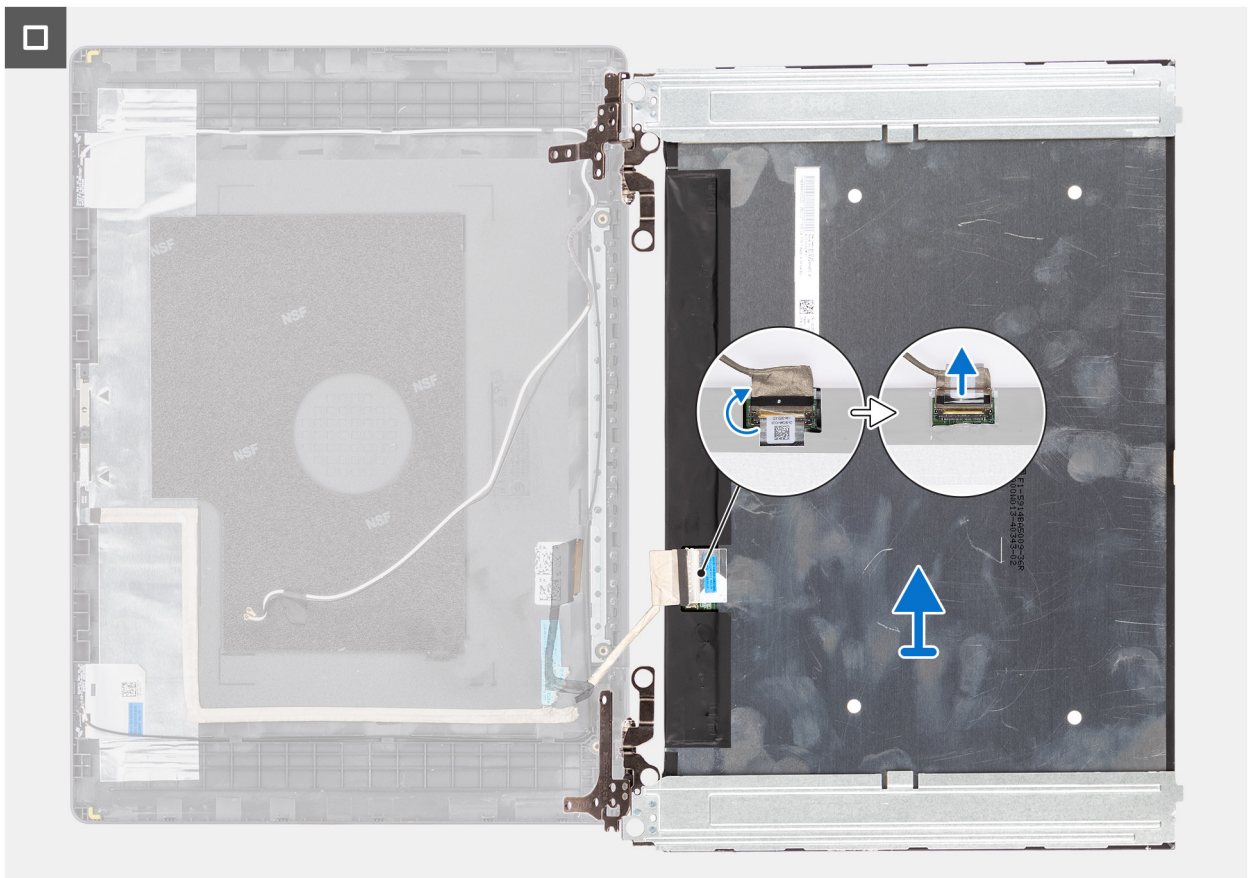

Figure 79. Removing the display panel

## Steps

1. Place the display back-cover and antenna assembly on a clean and flat surface.
2. Remove the six screws (M2.5x2.5) that secure the display panel to the display back-cover and antenna assembly.
3. Holding the display hinge, gently bend the bottom corner of the display back-cover and antenna assembly to release the right display hinge.
4. Repeat step 3 to release the left display hinge from the display back-cover and antenna assembly.
5. Holding the display hinges, slightly lift and slide the display panel down to release it from the catches on the top of the display back-cover and antenna assembly.
6. Gently flip the display panel assembly forward, peel back the tape that secures the display cable to the connector on the rear of the display panel.

**NOTE:** Ensure that the panel has a clean and smooth surface to rest on, to prevent damage.

7. Disconnect the display cable from the connector on the display panel and remove the display panel.

**WARNING:** The display panel is assembled with the display brackets and display hinges as a single service part. Do not pull the two pieces of elastic tape and separate the brackets from the panel.



Figure 80. Removing the display panel

## Installing the display panel for computers shipped with a plastic chassis

**CAUTION:** The information in this installation section is intended for authorized service technicians only.

### Prerequisites

If you are replacing a component, remove the existing component before performing the installation procedure.

**About this task**

**NOTE:** The display panel is assembled with the display brackets and display hinges as a single service part.

The following images indicate the location of the display panel and provide a visual representation of the installation procedure.



**6x**  
M2.5x2.5

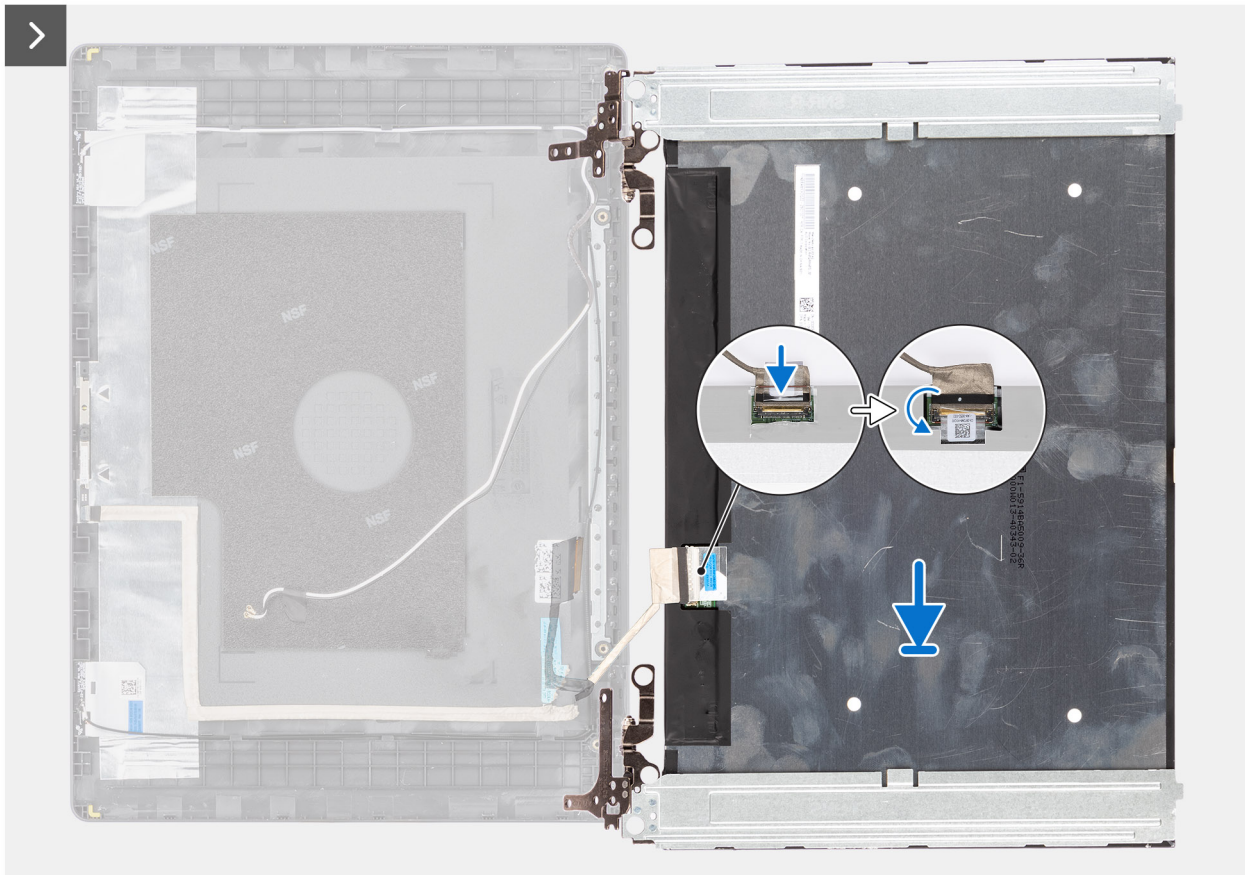

**Figure 81. Installing the display panel**



Figure 82. Installing the screws

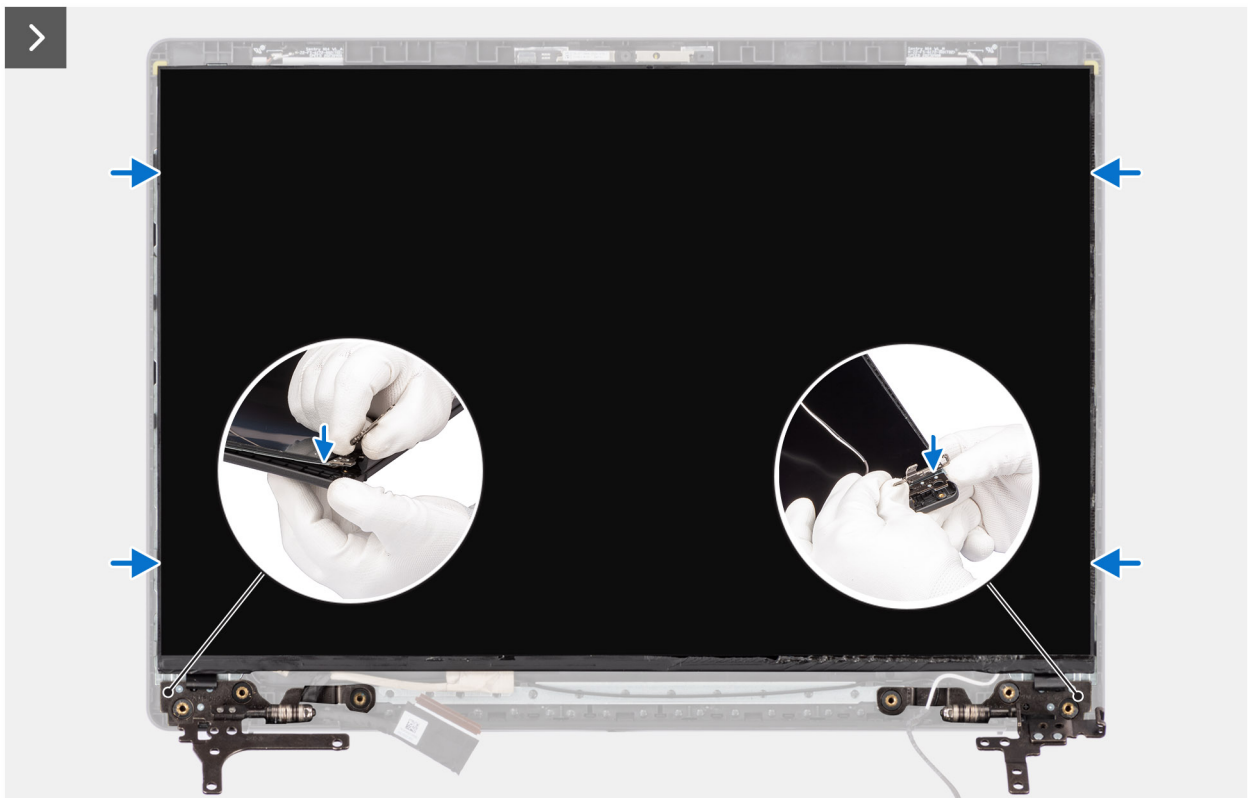
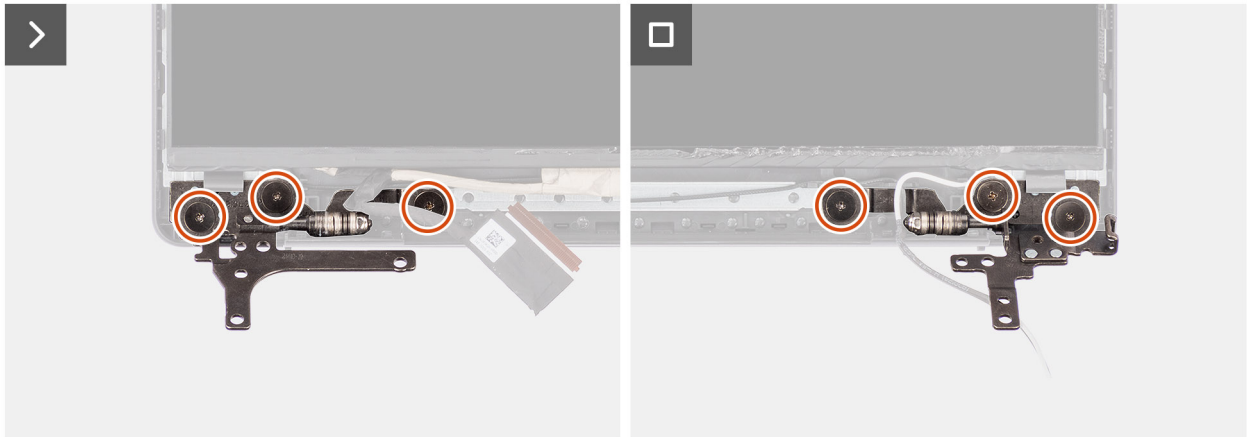

Figure 83. Installing the display panel



**Figure 84. Installing the display panel**

### Steps

1. Place the display panel and display assembly on a clean and flat surface.
  - NOTE:** Ensure that all cables are properly seated in their routing channels.
2. Connect the display cable to the connector on the display panel and close the latch.
3. Adhere the tape to secure the display cable to the connector on the display panel.
4. Turn the display panel over and place the display panel on the display back-cover.
5. Lift the bottom side of the display panel and slide the top side into the catches at the top of the display back-cover.
6. Gently bend the bottom corners of the display back-cover and lower the right and left display hinges into the clips on the display back-cover.
7. Replace the six screws (M2.5x2.5) to secure the display hinges to the display back-cover and antenna assembly.

### Next steps

1. Install the [display bezel](#) for computers shipped with a plastic chassis.
2. Install the [display assembly](#) for computers shipped with a plastic chassis.
3. Install the [wireless card](#) for computers shipped with a plastic chassis.
4. Install the [M.2 2230 solid-state drive](#) for computers shipped with a plastic chassis.
5. Install the [base cover](#) for computers shipped with a plastic chassis.
6. Follow the procedure in [After working inside your computer](#).

## Display cable

### Removing the display cable for computers shipped with a plastic chassis

**CAUTION:** The information in this removal section is intended for authorized service technicians only.

#### Prerequisites

1. Follow the procedure in [Before working inside your computer](#).
2. Remove the [base cover](#) for computers shipped with a plastic chassis.
3. Remove the [M.2 2230 solid-state drive](#) for computers shipped with a plastic chassis.
4. Remove the [wireless card](#) for computers shipped with a plastic chassis.
5. Remove the [display assembly](#) for computers shipped with a plastic chassis.
6. Remove the [display bezel](#) for computers shipped with a plastic chassis.
7. Remove the [display panel](#) for computers shipped with a plastic chassis.

### About this task

The following image indicates the location of the display cable and provides a visual representation of the removal procedure.

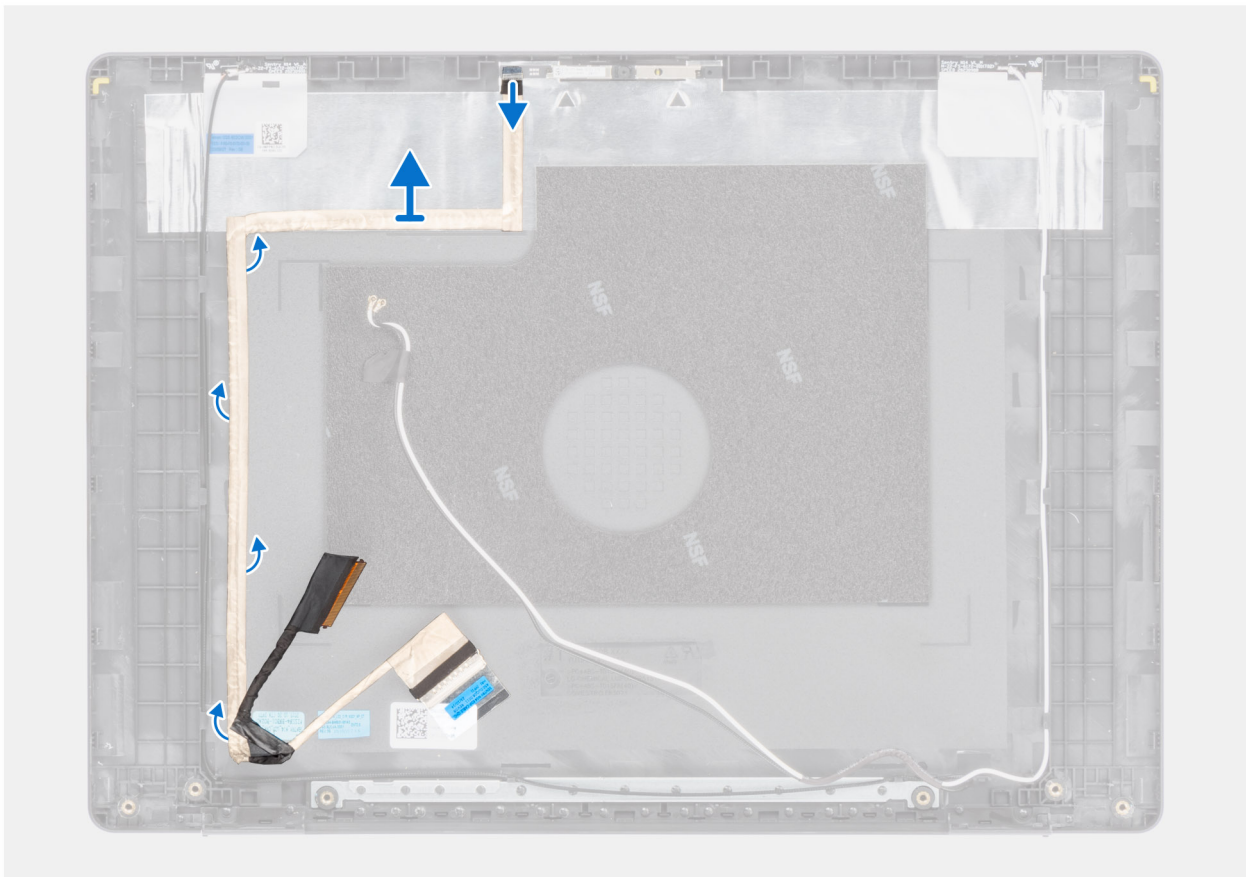
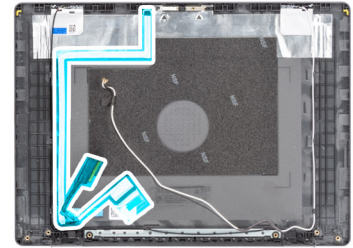

**Figure 85. Removing the display cable**

### Steps

1. Disconnect the display eDP cable from the connector on the camera module.
2. Carefully peel back and remove the display eDP cable from the display back-cover and antenna assembly.

## Installing the display cable for computers shipped with a plastic chassis

**CAUTION:** The information in this installation section is intended for authorized service technicians only.

### Prerequisites

If you are replacing a component, remove the existing component before performing the installation procedure.



### About this task

The following image indicates the location of the display cable and provides a visual representation of the installation procedure.

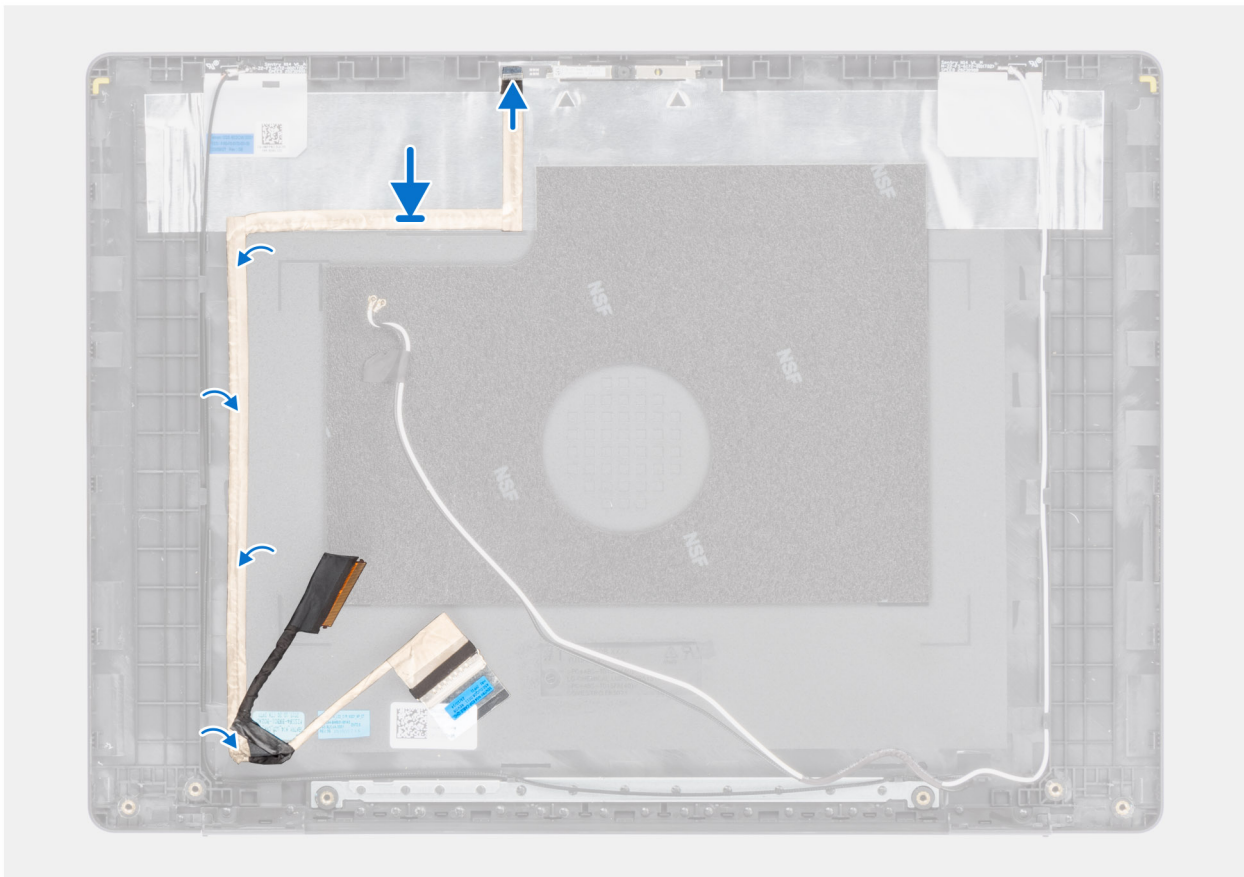
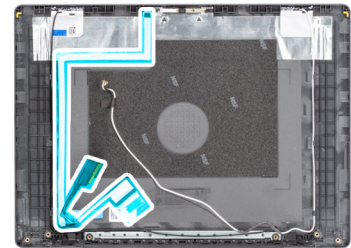

**Figure 86. Installing the display cable**

### Steps

1. Adhere the display eDP cable to the display back-cover and antenna assembly.
2. Connect the display eDP cable to the connector on the camera module.

### Next steps

1. Install the [display panel](#) for computers shipped with a plastic chassis.
2. Install the [display bezel](#) for computers shipped with a plastic chassis.
3. Install the [display assembly](#) for computers shipped with a plastic chassis.
4. Install the [wireless card](#) for computers shipped with a plastic chassis.
5. Install the [M.2 2230 solid-state drive](#) for computers shipped with a plastic chassis.
6. Install the [base cover](#) for computers shipped with a plastic chassis.
7. Follow the procedure in [After working inside your computer](#).

# Camera

## Removing the camera for computers shipped with a plastic chassis

**CAUTION:** The information in this removal section is intended for authorized service technicians only.

### Prerequisites

1. Follow the procedure in [Before working inside your computer](#).
2. Remove the [base cover](#) for computers shipped with a plastic chassis.
3. Remove the [M.2 2230 solid-state drive](#) for computers shipped with a plastic chassis.
4. Remove the [wireless card](#) for computers shipped with a plastic chassis.
5. Remove the [display assembly](#) for computers shipped with a plastic chassis.
6. Remove the [display bezel](#) for computers shipped with a plastic chassis.
7. Remove the [display panel](#) for computers shipped with a plastic chassis.

### About this task

The following images indicate the location of the camera module and provide a visual representation of the removal procedure.

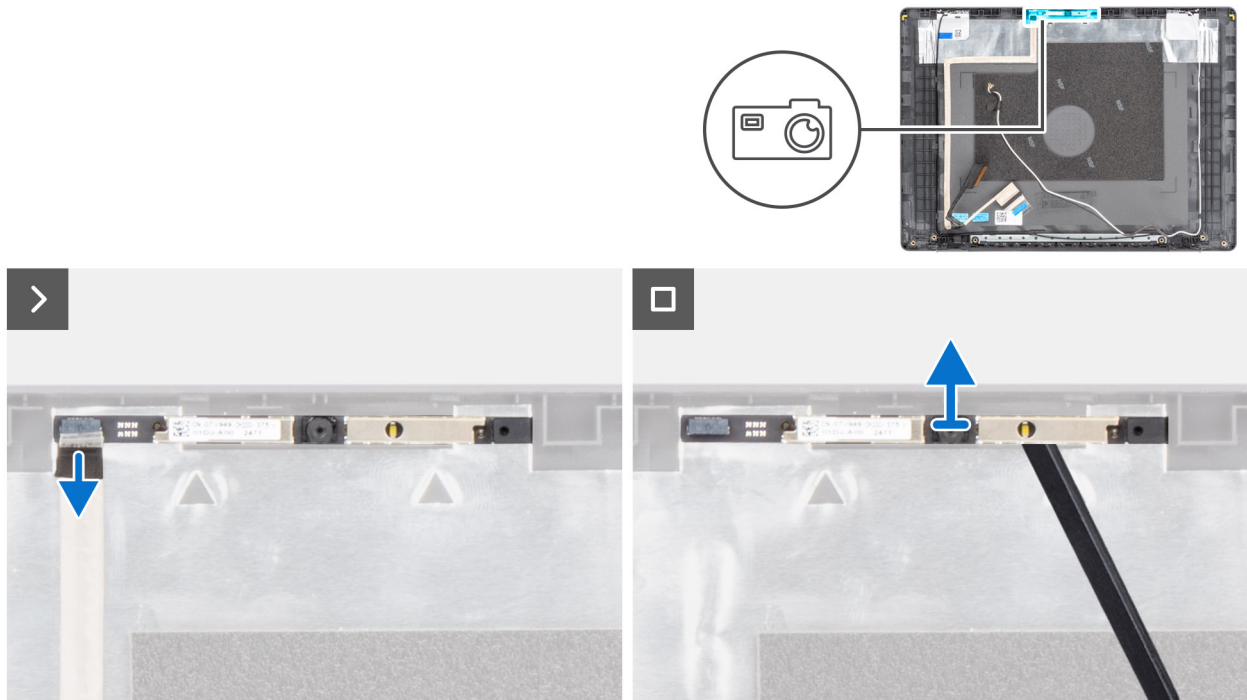

**Figure 87. Removing the camera**

### Steps

1. Disconnect the display cable from the connector on the camera module.
2. Using a plastic scribe, gently pry the camera off the display back-cover and antenna assembly.
3. Remove the camera module from the display assembly.

## Installing the camera for computers shipped with a plastic chassis

**CAUTION:** The information in this installation section is intended for authorized service technicians only.

## Prerequisites

If you are replacing a component, remove the existing component before performing the installation procedure.

## About this task

The following images indicate the location of the camera module and provide a visual representation of the installation procedure.

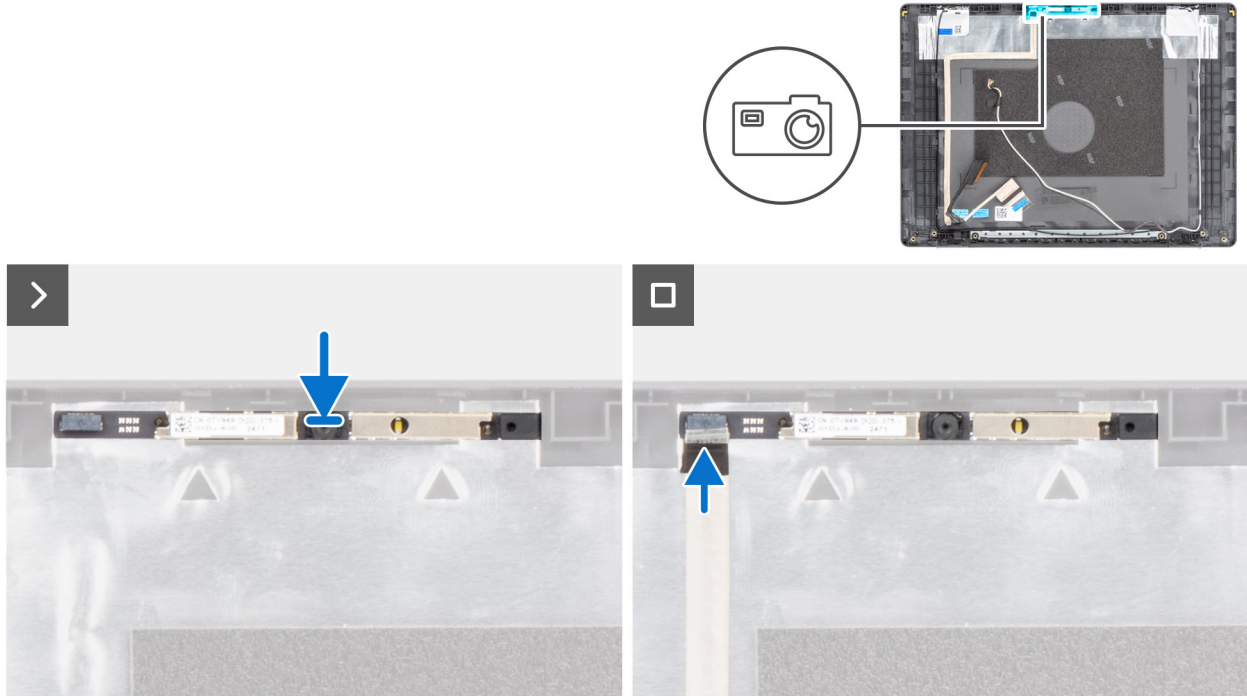

Figure 88. Installing the camera

## Steps

1. Using the alignment post, adhere the camera module on the display back-cover and antenna assembly.
2. Connect the display cable to the connector on the camera module.

## Next steps

1. Install the [display panel for computers shipped with a plastic chassis](#).
2. Install the [display bezel for computers shipped with a plastic chassis](#).
3. Install the [display assembly for computers shipped with a plastic chassis](#).
4. Install the [wireless card for computers shipped with a plastic chassis](#).
5. Install the [M.2 2230 solid-state drive for computers shipped with a plastic chassis](#).
6. Install the [base cover for computers shipped with a plastic chassis](#).
7. Follow the procedure in [After working inside your computer](#).

# Display back-cover and antenna assembly

## Removing the display back-cover and antenna assembly

**CAUTION:** The information in this removal section is intended for authorized service technicians only.

## Prerequisites

1. Follow the procedure in [Before working inside your computer](#).

2. Remove the [base cover](#) for computers shipped with a plastic chassis.
3. Remove the [M.2 2230 solid-state drive](#) for computers shipped with a plastic chassis.
4. Remove the [wireless card](#) for computers shipped with a plastic chassis.
5. Remove the [display assembly](#) for computers shipped with a plastic chassis.
6. Remove the [display bezel](#) for computers shipped with a plastic chassis.
7. Remove the [display panel](#) for computers shipped with a plastic chassis.
8. Remove the [camera](#) for computer shipped with a plastic chassis.

#### About this task

**NOTE:** The display back-cover and antenna assembly cannot be further disassembled once all the **Prerequisites** are completed. If the wireless antennas are malfunctioning and are required to be replaced, replace the entire display back-cover and antenna assembly.

The image below shows the display back-cover and antenna assembly after the **Prerequisites** have been performed.

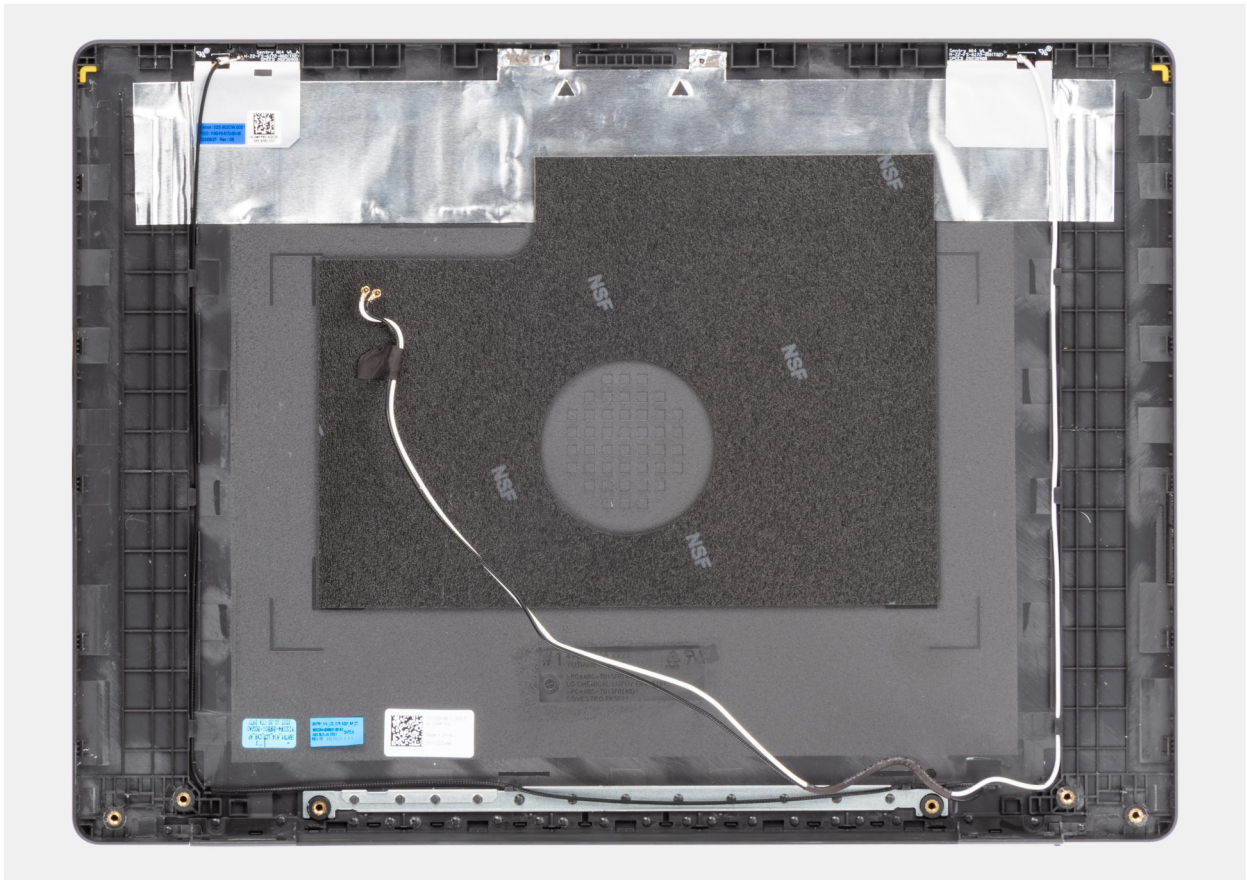

**Figure 89. Display back-cover and antenna assembly**

#### Steps

After performing the **Prerequisites**, you are left with the display back-cover and antenna assembly.

## Installing the display back-cover and antenna assembly

**CAUTION:** The information in this installation section is intended for authorized service technicians only.

#### Prerequisites

If you are replacing a component, remove the existing component before performing the installation procedure.

## About this task

The following image indicates the location of the display back-cover and antenna assembly and provides a visual representation of the installation procedure.

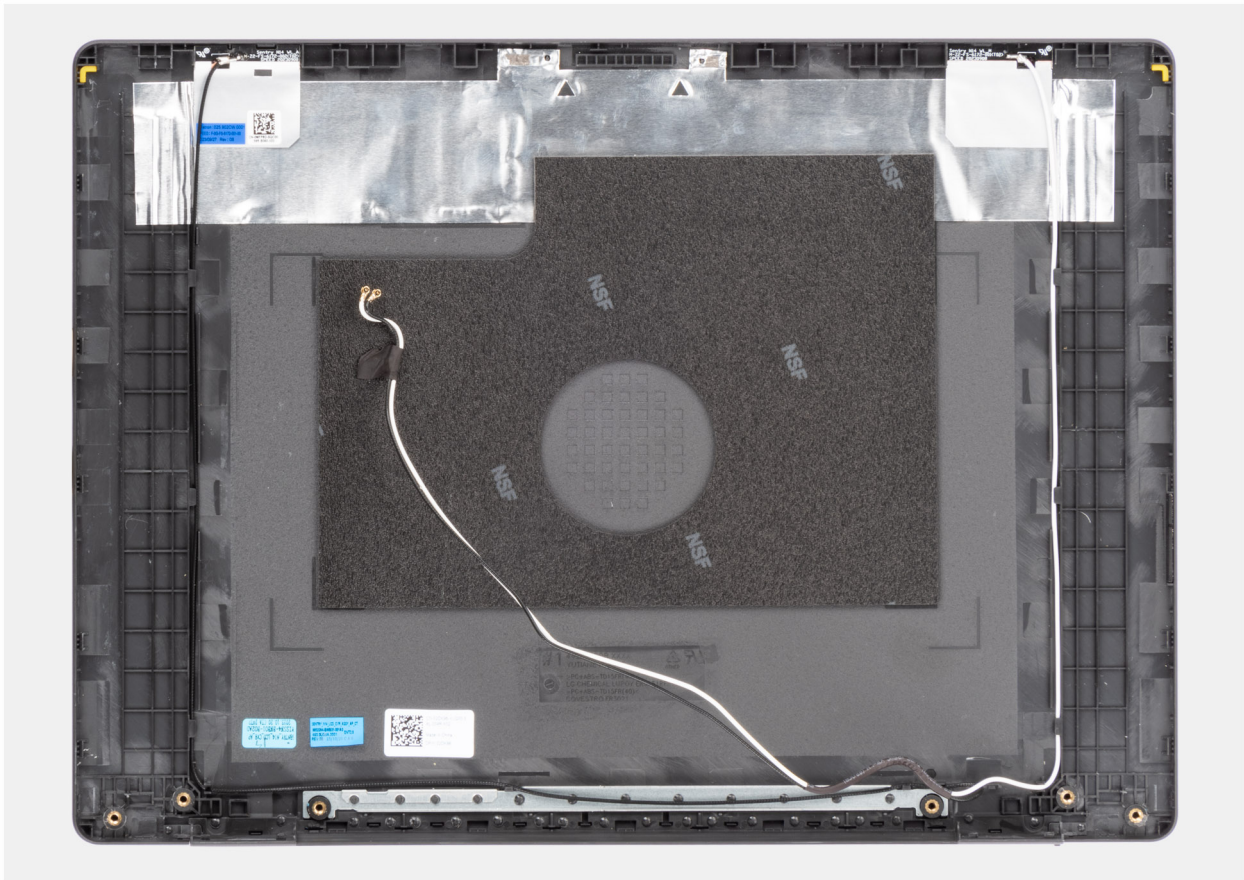

**Figure 90. Display back-cover and antenna assembly**

## Steps

Place the display back-cover and antenna assembly on a flat surface and perform the **Next steps** to install the display back-cover and antenna assembly.

## Next steps

1. Install the [camera](#) for computers shipped with a plastic chassis.
2. Install the [display panel](#) for computers shipped with a plastic chassis.
3. Install the [display bezel](#) for computers shipped with a plastic chassis.
4. Install the [display assembly](#) for computers shipped with a plastic chassis.
5. Install the [wireless card](#) for computers shipped with a plastic chassis.
6. Install the [M.2 2230 solid-state drive](#) for computers shipped with a plastic chassis.
7. Install the [base cover](#) for computers shipped with a plastic chassis.
8. Follow the procedure in [After working inside your computer](#).

# System board

## Removing the system board for computers shipped with a plastic chassis

**CAUTION:** The information in this section is intended for authorized service technicians only.

## Prerequisites

1. Follow the procedure in [Before working inside your computer](#).

**NOTE:** Ensure that your computer is in Service Mode. For more information see, [Before working inside your computer](#).

2. Remove the [base cover for computers shipped with a plastic chassis](#).
3. Remove the [battery for computers shipped with a plastic chassis](#).
4. Remove the [wireless card for computers shipped with a plastic chassis](#).
5. Remove the [M.2 2230 solid-state drive for computers shipped with a plastic chassis](#).
6. Remove the [fan for computers shipped with a plastic chassis](#).
7. Remove the [heatsink](#).

**NOTE:** The system board can be removed and installed along with the heat sink, when you replace the palm-rest and keyboard assembly. This simplifies the removal and installation procedure and prevents damage to the thermal bond between the system board and heat sink.

8. Remove the [display assembly for computers shipped with a plastic chassis](#).

## About this task

The following image indicates the connectors on your system board.

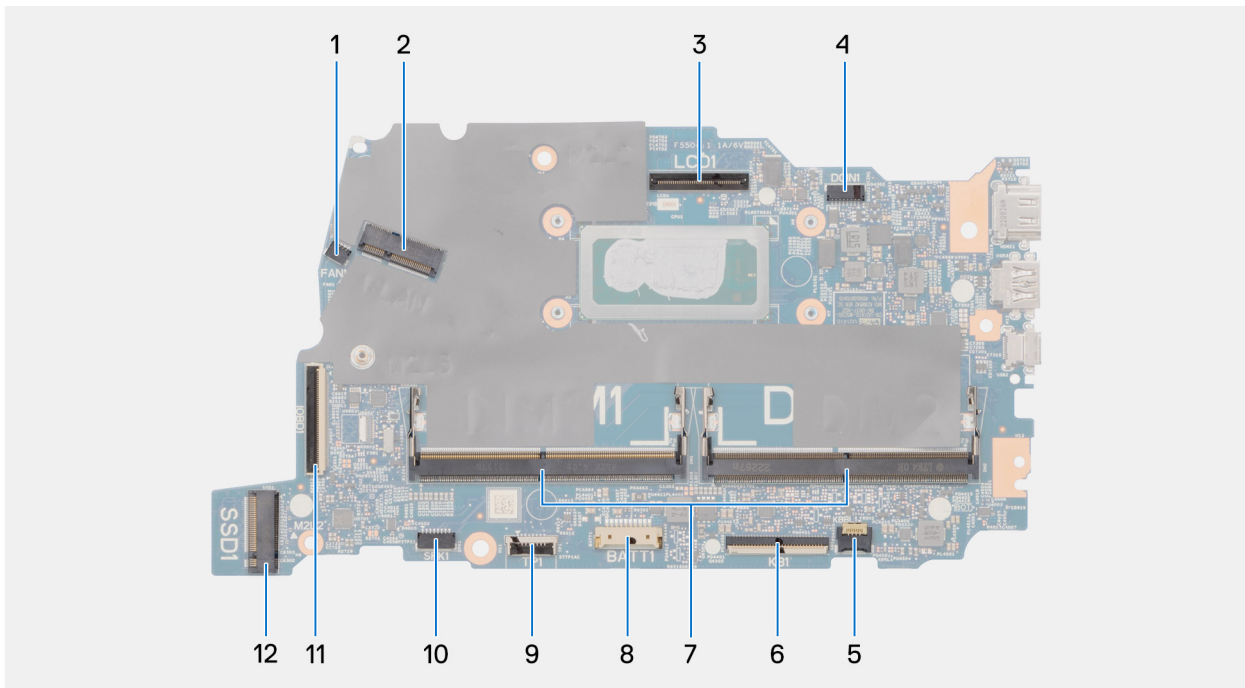

**Figure 91. Connectors on the system board**

1. Fan-cable connector (FN1)
2. M.2 wireless-card connector
3. Display-cable connector (LCD)
4. Power port connector (DC IN1)
5. Memory module connector
6. Keyboard-backlight cable connector (KBBL1)
7. Keyboard-cable connector (KB1)
8. Battery-cable connector (BATT1)
9. Touchpad-cable connector (TP1)
10. Speaker-cable connector (SPK1)
11. I/O-board cable connector (IOBD1)
12. M.2 solid-state drive connector (SSD1)

The following images indicate the location of the system board and provide a visual representation of the removal procedure.

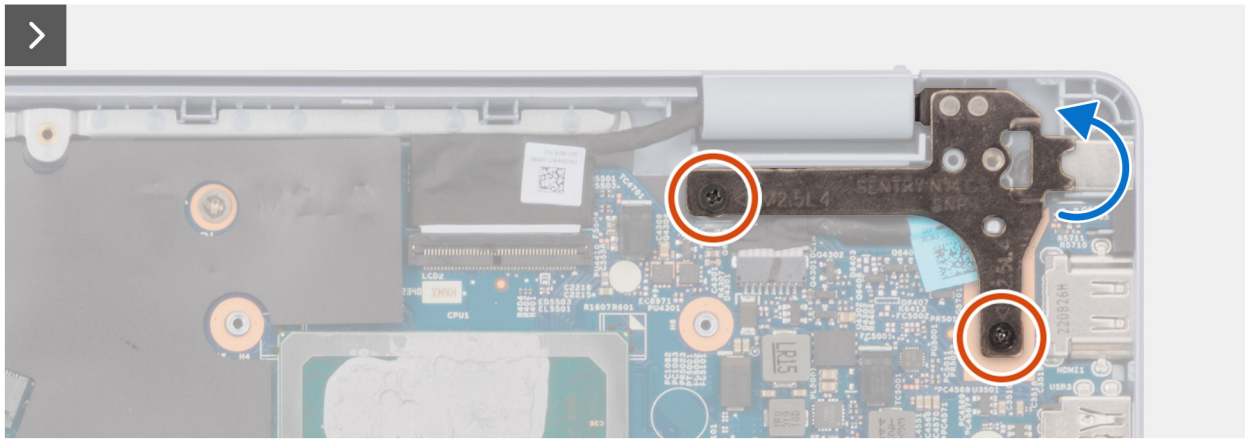
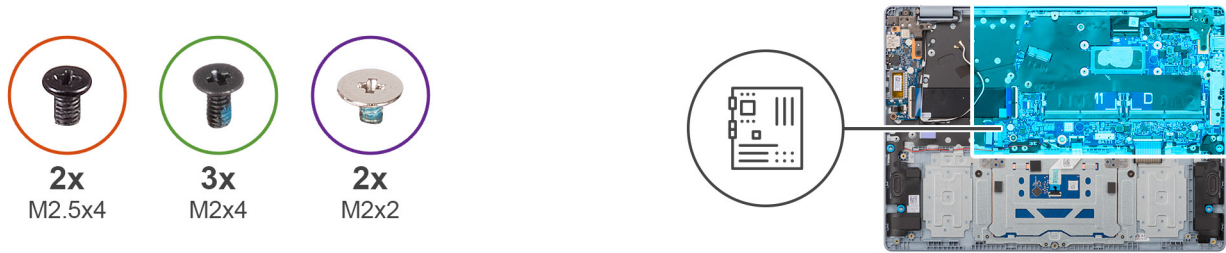

Figure 92. Removing the screws

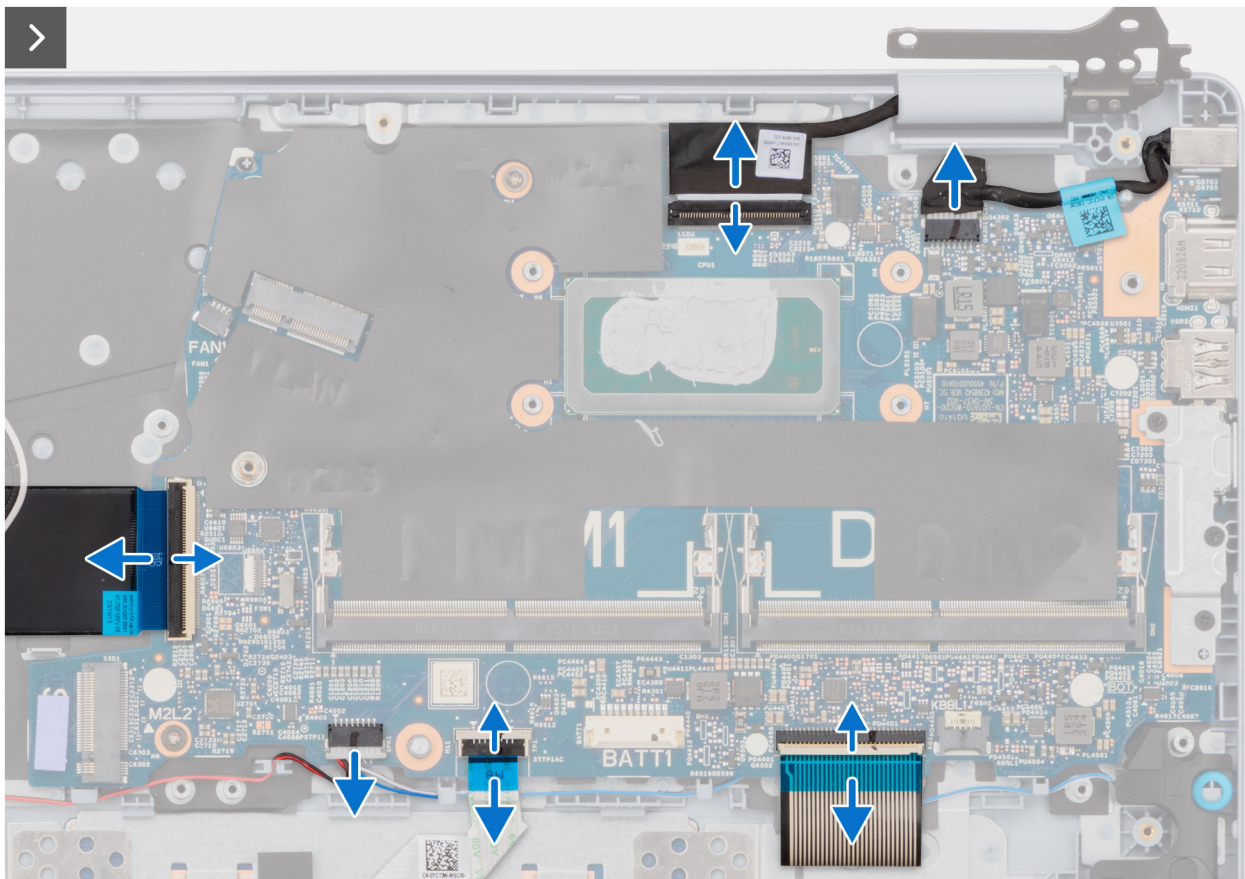
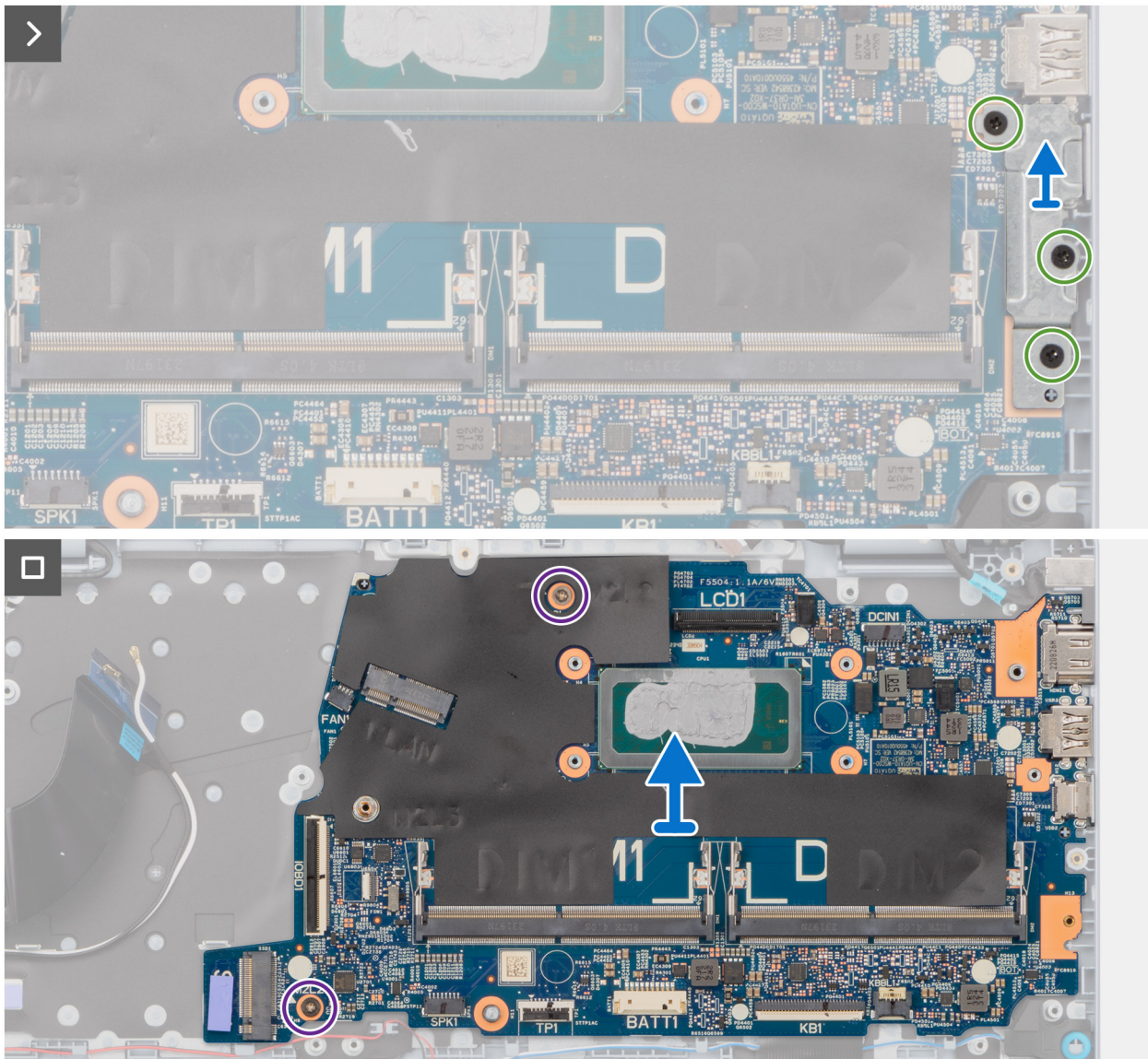

Figure 93. Removing the cable connectors



**Figure 94. Removing the system board**

**Steps**

1. Remove the two screws (M2.5x4) that secure the right hinge to the system board.
2. Rotate and open the right hinge.
3. Peel the tape that secures the I/O-board connector (IOBD1) latch to the system board.
4. Open the latch and disconnect the I/O-board cable from the connector (IOBD1) on the system board.
5. Disconnect the speaker cable from the connector (SPK1) on the system board.
6. Open the latch and disconnect the touchpad cable from the connector (TP1) on the system board.
7. Open the latch and disconnect the keyboard cable from the connector (KB1) on the system board.
8. Open the latch and disconnect the keyboard-backlight cable from the connector (KBBL1) on the system board.
9. Remove the three screws (M2x4) that secure the USB Type-C bracket to the system board.
10. Lift the USB Type-C bracket off the system board.
11. Remove the two screws (M2x2) that secure the system board to the palm-rest and keyboard assembly.
12. Lift the system board off the palm-rest and keyboard assembly.



# Installing the system board for computers shipped with a plastic chassis

**CAUTION:** The information in this section is intended for authorized service technicians only.

## Prerequisites

If you are replacing a component, remove the existing component before performing the installation process.

## About this task

The following image indicates the connectors on your system board.

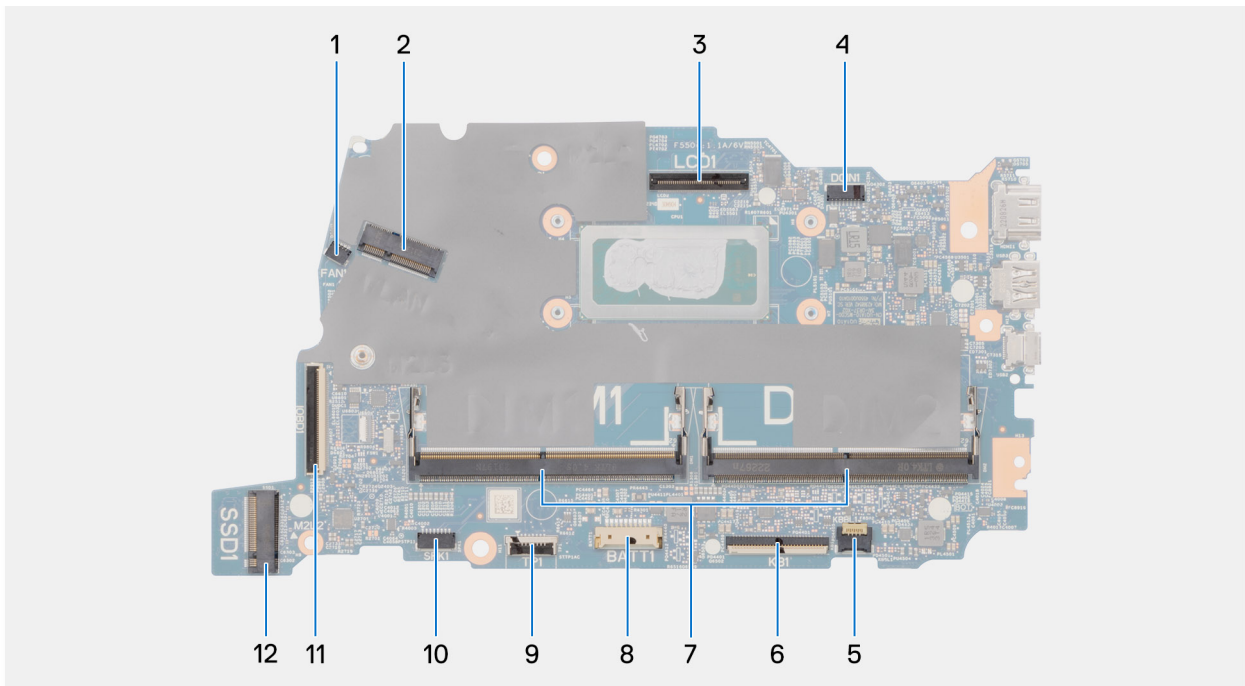

**Figure 95. Connectors on the system board**

1. Fan-cable connector (FN1)
2. M.2 wireless-card connector
3. Display-cable connector (LCD)
4. Power port connector (DC IN1)
5. Memory module connector
6. Keyboard-backlight cable connector (KBBL1)
7. Keyboard-cable connector (KB1)
8. Battery-cable connector (BATT1)
9. Touchpad-cable connector (TP1)
10. Speaker-cable connector (SPK1)
11. I/O-board cable connector (IOBD1)
12. M.2 solid-state drive connector (SSD1)

The following images indicate the location of the system board and provide a visual representation of the installation procedure.

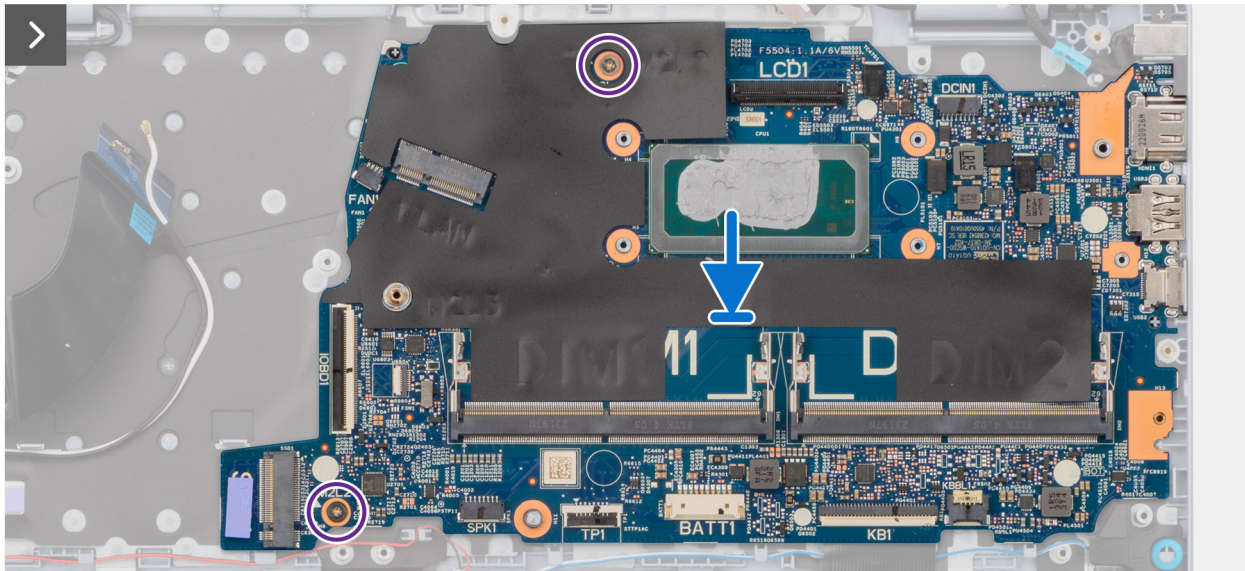
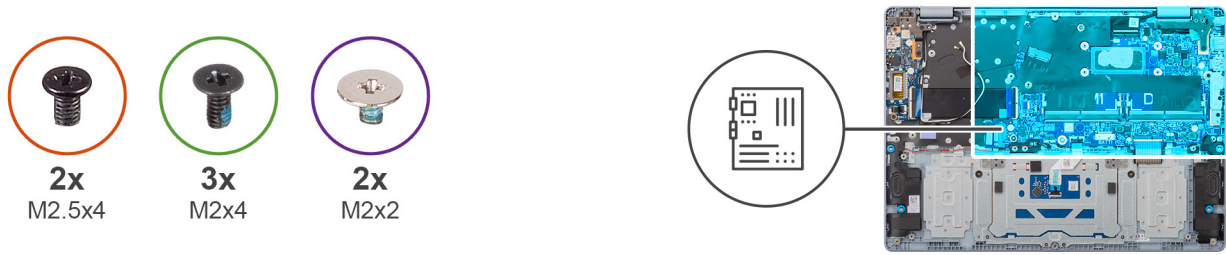

Figure 96. Installing the system board

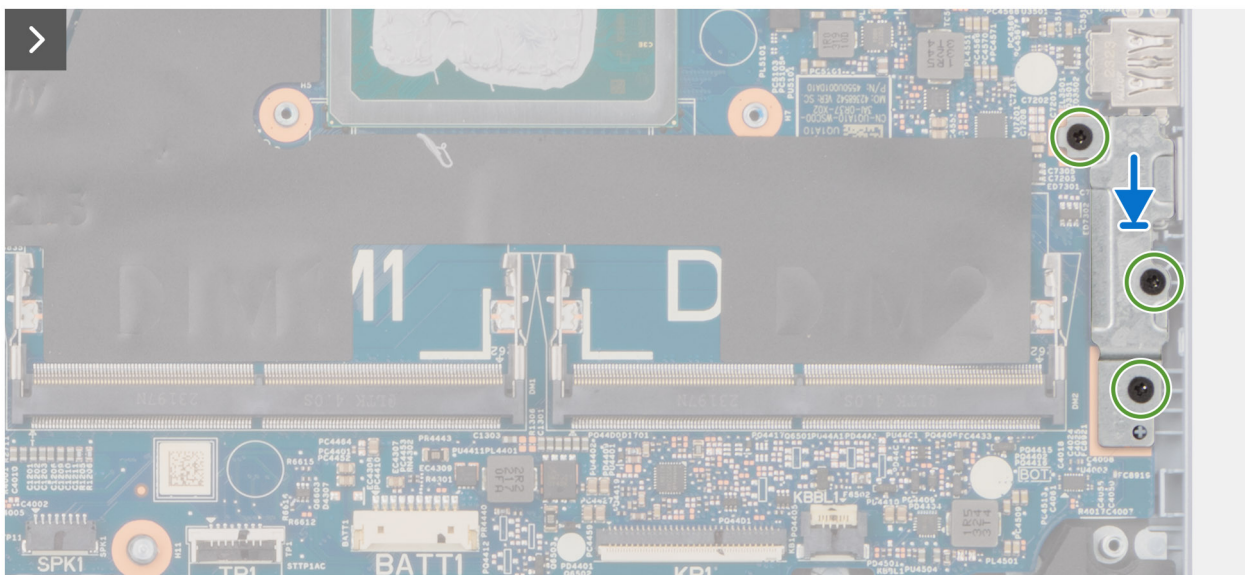
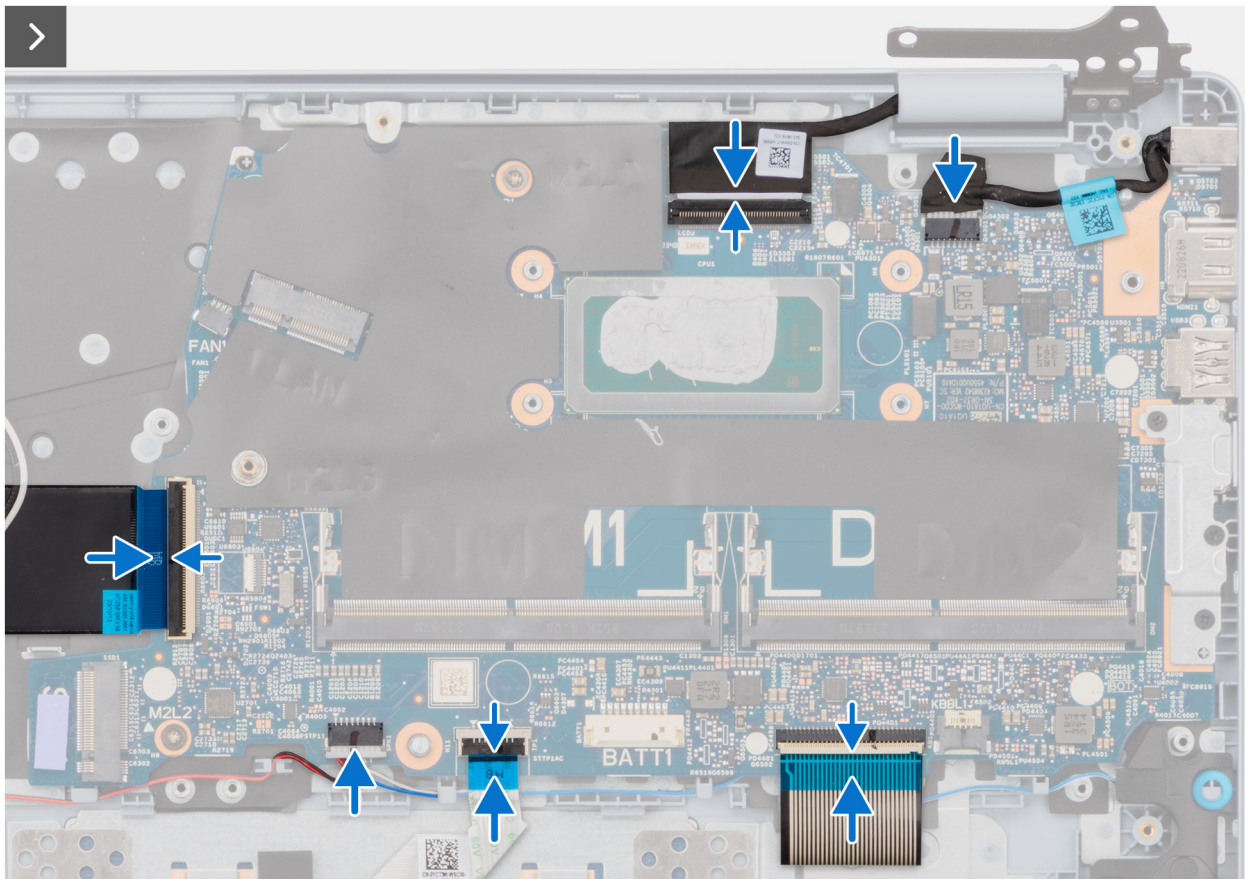
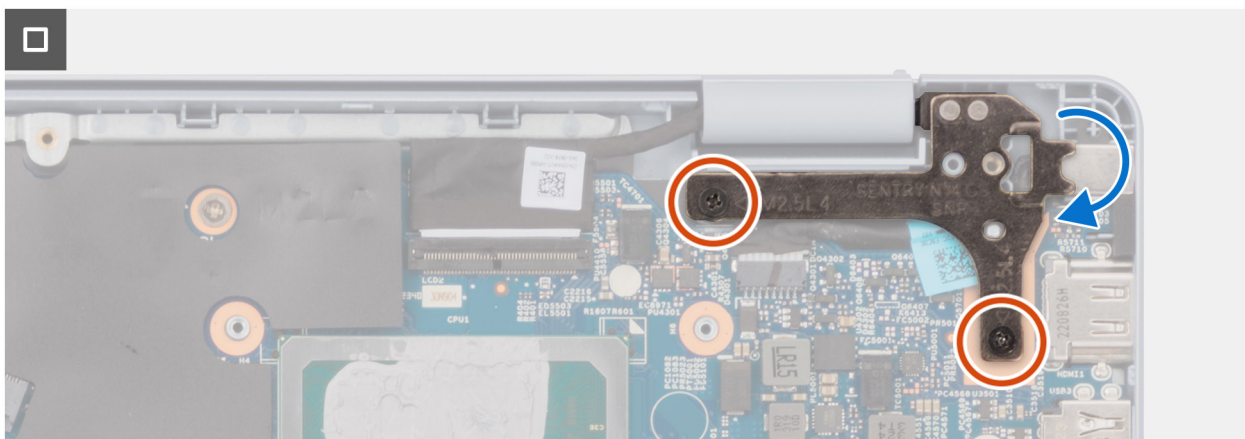

Figure 97. Replacing the USB Type-C bracket



**Figure 98. Replacing the cable connectors**



**Figure 99. Replacing the hinge screws**

**Steps**

1. Align the screw holes on the system board with the screw holes on the palm-rest and keyboard assembly.
2. Replace the two screws (M2x2) that secure the system board to the palm-rest and keyboard assembly.
3. Align the screw holes on the USB Type-C bracket to the screw holes on the system board.
4. Replace the three screws (M2x4) that secure the USB Type-C bracket to the system board.
5. Connect the I/O board cable to the connector (IOBD1) on the system board.
6. Connect the speaker cable to the connector (SPK1) on the speaker board.
7. Connect the touchpad cable to the connector (TP1) system board and close the latch.
8. Connect the keyboard cable to the connector (KB1) system board and close the latch.

9. Connect the keyboard-backlight cable to the connector (KBBL1) system board and close the latch.
10. Rotate to close the right hinge.
11. Replace the two screws (M2.5x4) to secure the right hinge to the system board.

### Next steps

1. Install the [display assembly for computers shipped with a plastic chassis](#).
2. Install the [heatsink](#) .

**i** **NOTE:** The system board can be removed and installed along with the heat sink, when you replace the palm-rest and keyboard assembly. This simplifies the removal and installation procedure and prevents damage to the thermal bond between the system board and heat sink.

3. Install the [fan for computers shipped with a plastic chassis](#).
4. Install the [M.2 2230 solid-state drive for computers shipped with a plastic chassis](#).
5. Install the [wireless card for computers shipped with a plastic chassis](#).
6. Install the [battery for computers shipped with a plastic chassis](#).
7. Install the [base cover for computers shipped with a plastic chassis](#).
8. Follow the procedure in [After working inside your computer](#).

## Removing the system board for computers shipped with an aluminum chassis

**⚠** **CAUTION:** The information in this section is intended for authorized service technicians only.

### Prerequisites

1. Follow the procedure in [Before working inside your computer](#).

**i** **NOTE:** Ensure that your computer is in Service Mode. For more information see, [Before working inside your computer](#).

2. Remove the [base cover for computers shipped with an aluminum chassis](#).
3. Remove the [54 W battery for computers shipped with an aluminum chassis](#).
4. Remove the [wireless card for computers shipped with an aluminum chassis](#).
5. Remove the [M.2 2230 solid-state drive for computers shipped with an aluminum chassis](#).
6. Remove the [fan for computers shipped with an aluminum chassis](#).
7. Remove the [heatsink](#).

**i** **NOTE:** The system board can be removed and installed along with the heat sink, when you replace the palm-rest and keyboard assembly. This simplifies the removal and installation procedure and prevents damage to the thermal bond between the system board and heat sink.

8. Remove the [display assembly for computers shipped with an aluminum chassis](#).

### About this task

The following image indicates the connectors on your system board.

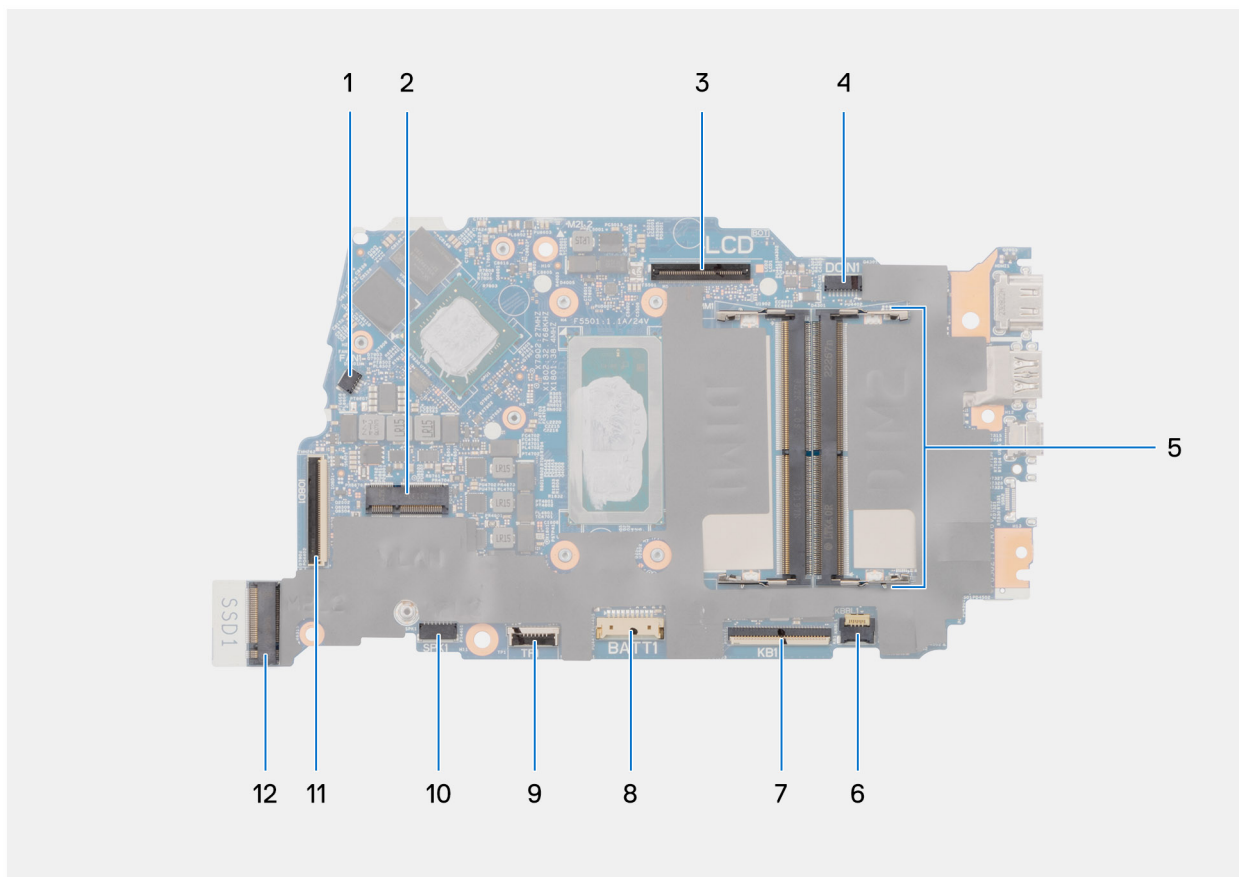

**Figure 100. Connectors on the system board**

1. Fan-cable connector (FN1)
2. M.2 wireless-card connector
3. Display-cable connector (LCD)
4. Power port connector (DC IN1)
5. Memory module connector
6. Keyboard-backlight cable connector (KBBL1)
7. Keyboard-cable connector (KB1)
8. Battery-cable connector (BATT1)
9. Touchpad-cable connector (TP1)
10. Speaker-cable connector (SPK1)
11. I/O-board cable connector (IOBD1)
12. M.2 solid-state drive connector (SSD1)

The following images indicate the location of the system board and provide a visual representation of the removal procedure.

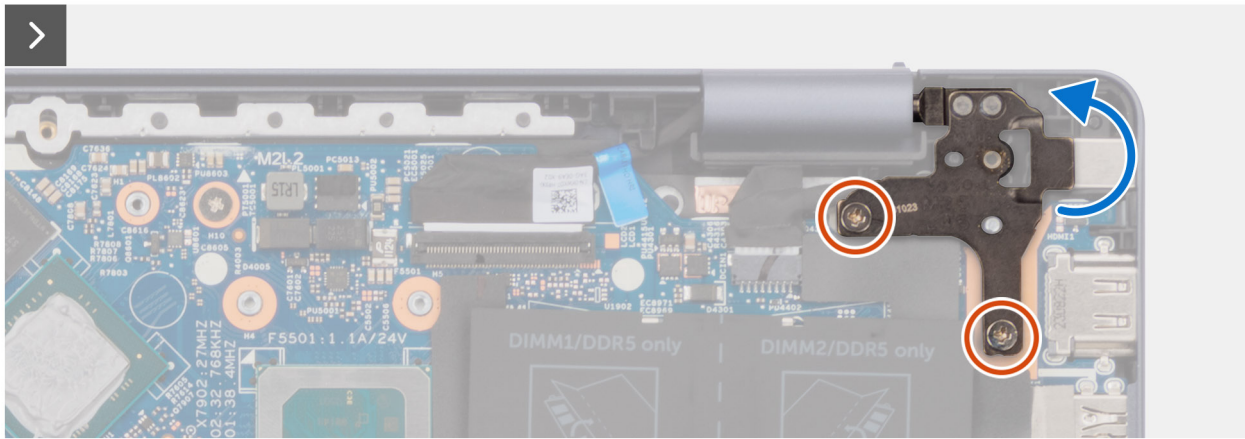
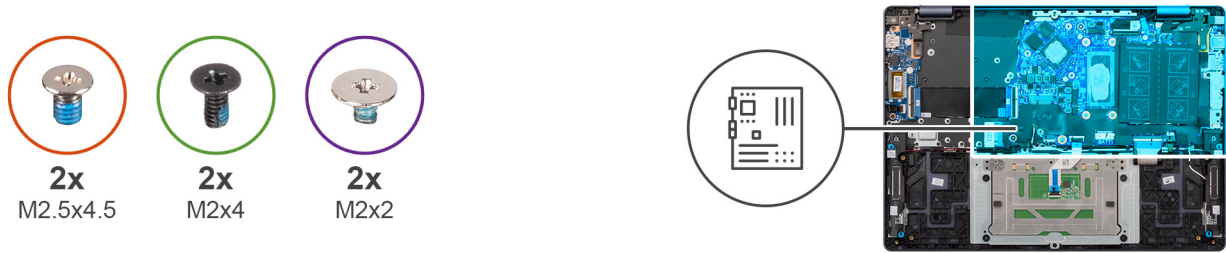

Figure 101. Removing the hinge screws

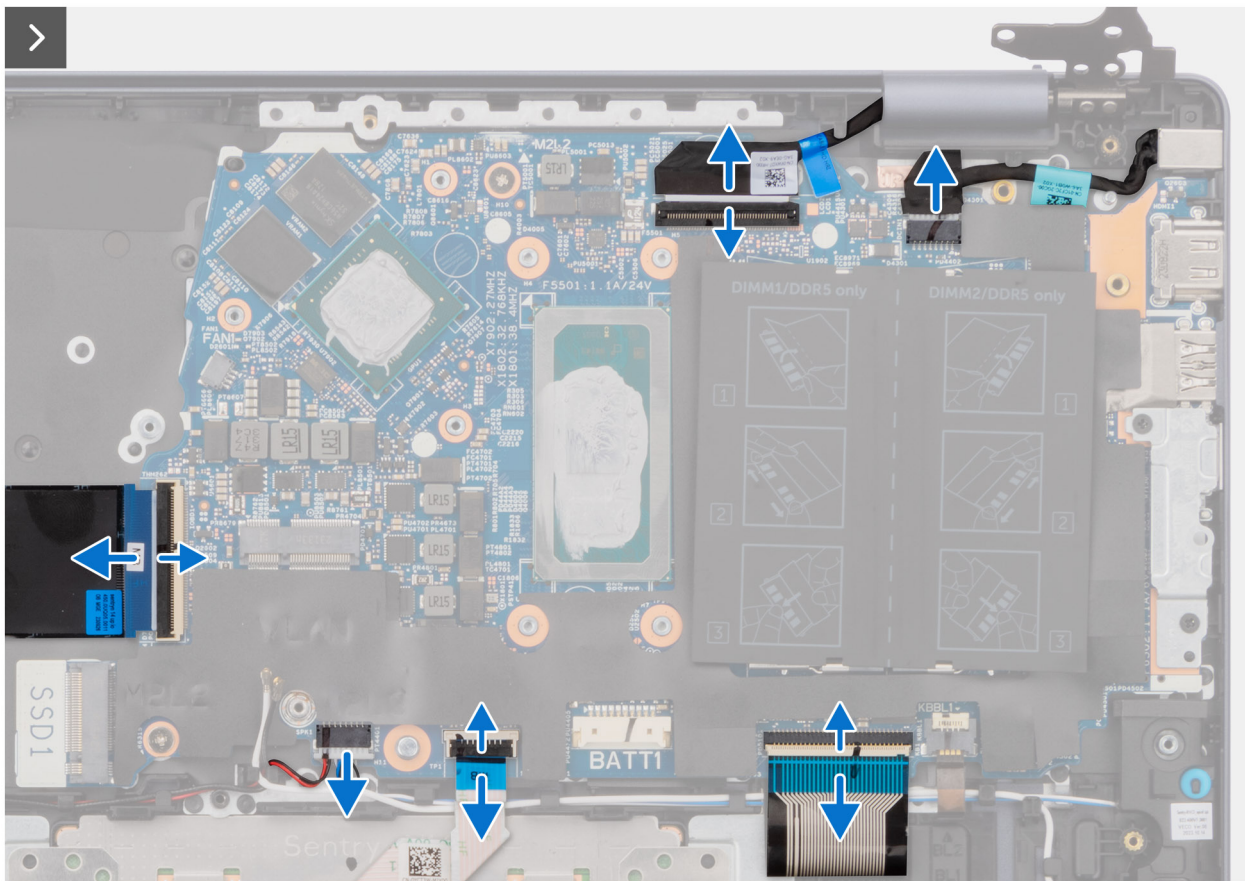
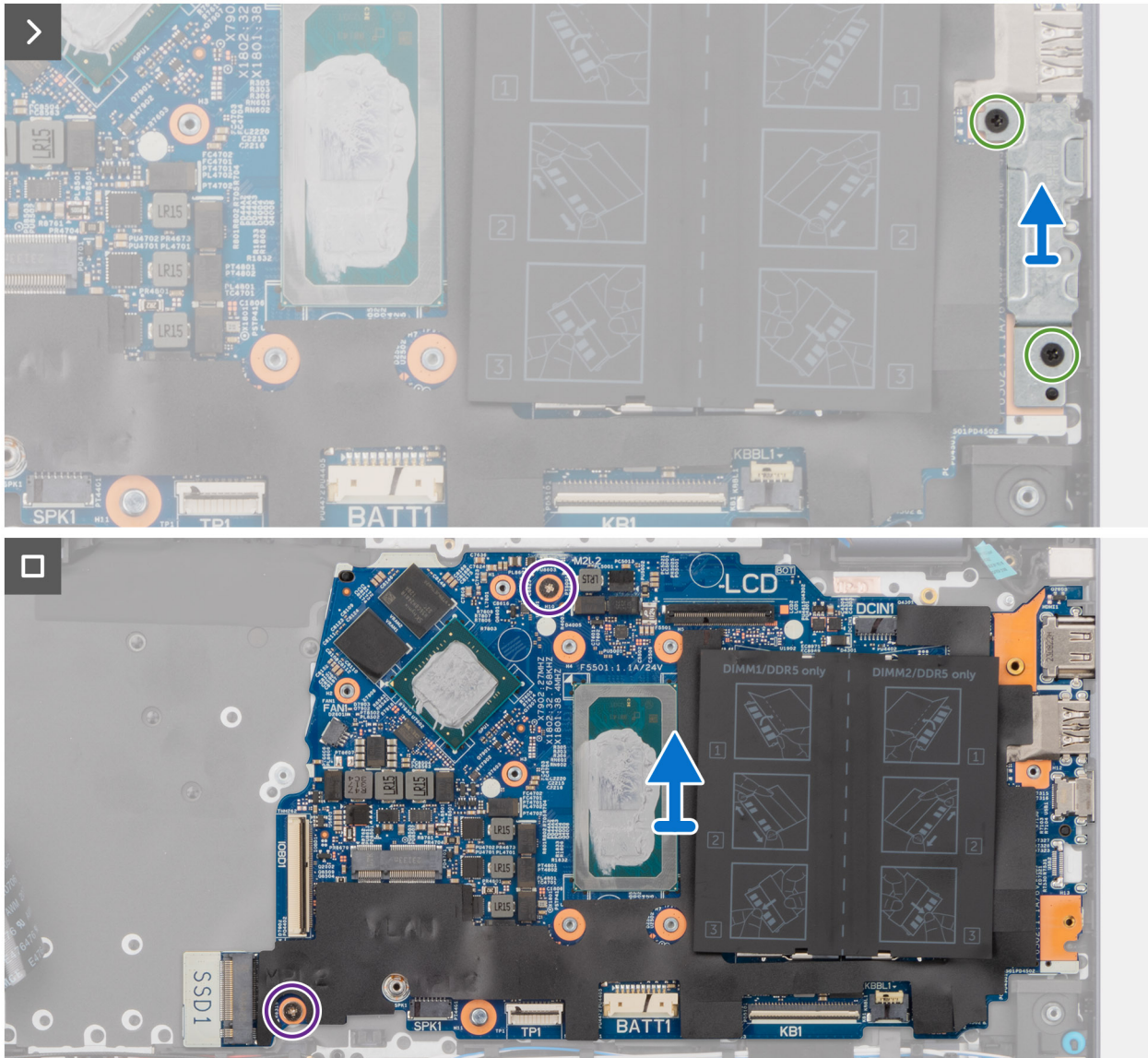

Figure 102. Removing the cable connectors



**Figure 103. Removing the system board**

**Steps**

1. Remove the two screws (M2.5x4.5) that secure the right hinge to the system board.
2. Rotate and open the right hinge.
3. Peel the tape that secures the I/O-board connector (IOBD1) latch to the system board.
4. Lift the latch and disconnect the I/O-board cable from the connector (IOBD1) on the system board.
5. Disconnect the speaker cable from the connector (SPK1) on the system board.
6. Lift the latch and disconnect the touchpad cable from the connector (TP1) on the system board.
7. Lift the latch and disconnect the keyboard cable from the connector (KB1) on the system board.
8. Lift the latch and disconnect the keyboard-backlight cable from the connector (KBBL1) on the system board.
9. Remove the two screws (M2x4) that secure the USB Type-C bracket to the system board.
10. Lift the USB Type-C bracket off the system board.
11. Remove the two screws (M2x2) that secure the system board to the palm-rest and keyboard assembly.
12. Lift the system board off the palm-rest and keyboard assembly.

# Installing the system board for computers shipped with an aluminum chassis

**CAUTION:** The information in this section is intended for authorized service technicians only.

## Prerequisites

If you are replacing a component, remove the existing component before performing the installation process.

## About this task

The following image indicates the connectors on your system board.

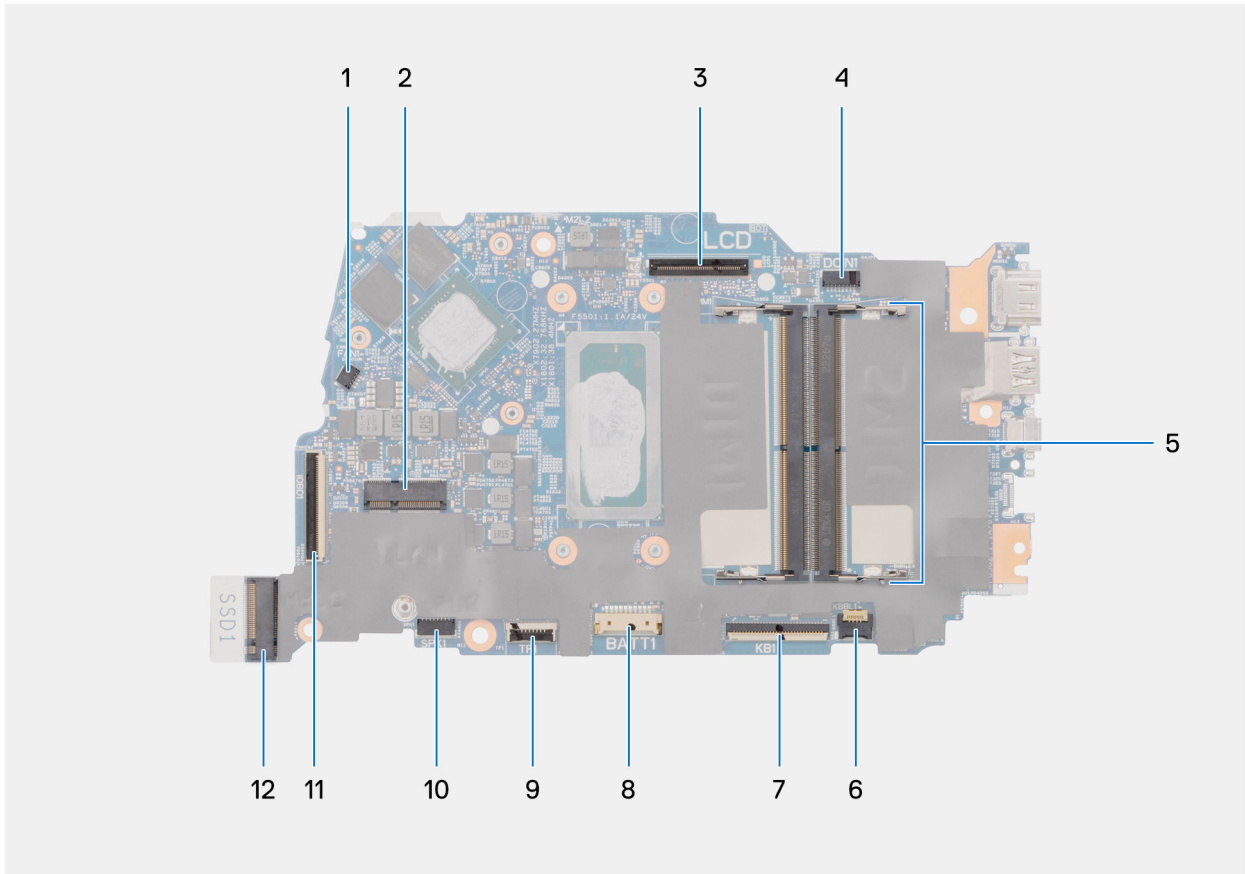

**Figure 104. Connectors on the system board**

1. Fan-cable connector (FN1)
2. M.2 wireless-card connector
3. Display-cable connector (LCD)
4. Power port connector (DC IN1)
5. Memory module connector
6. Keyboard-backlight cable connector (KBBL1)
7. Keyboard-cable connector (KB1)
8. Battery-cable connector (BATT1)
9. Touchpad-cable connector (TP1)
10. Speaker-cable connector (SPK1)
11. I/O-board cable connector (IOBD1)
12. M.2 solid-state drive connector (SSD1)

The following images indicate the location of the system board and provide a visual representation of the installation procedure.



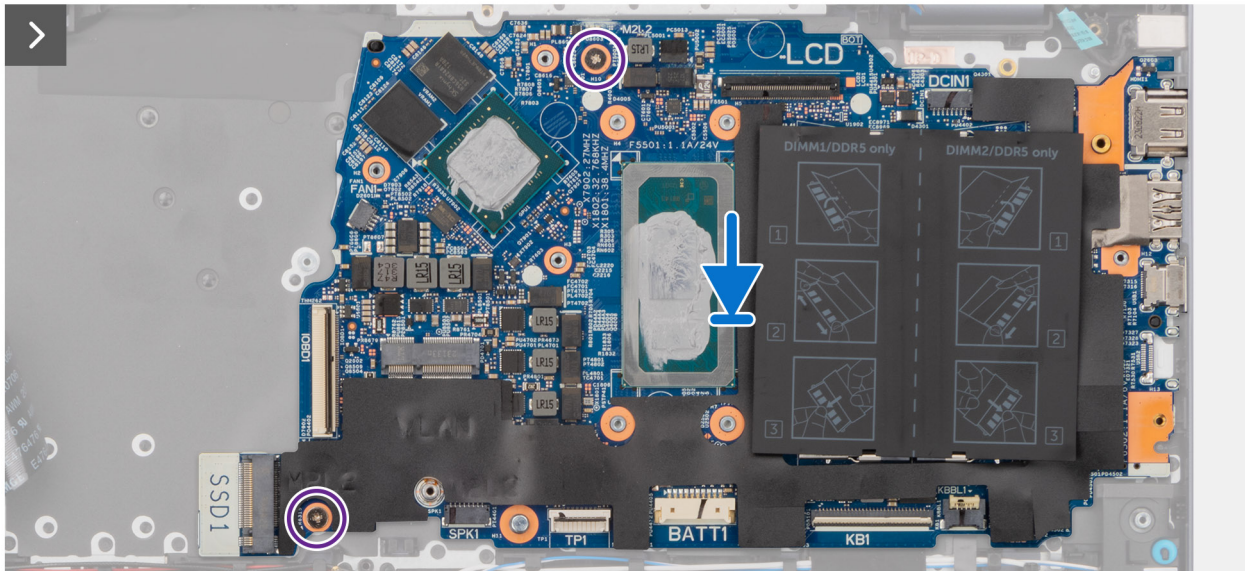
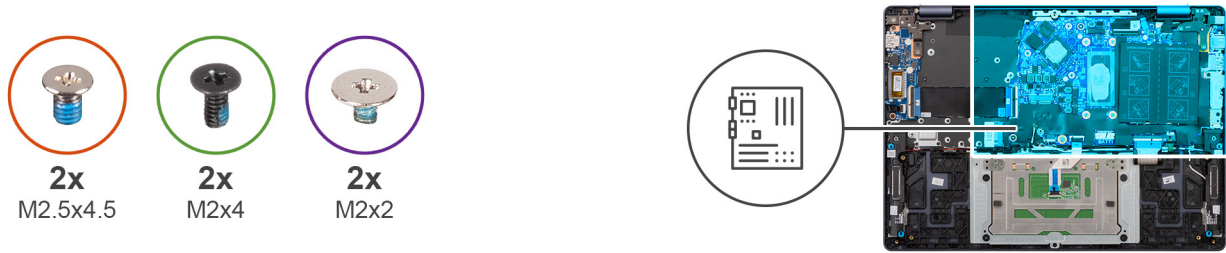

Figure 105. Installing the system board

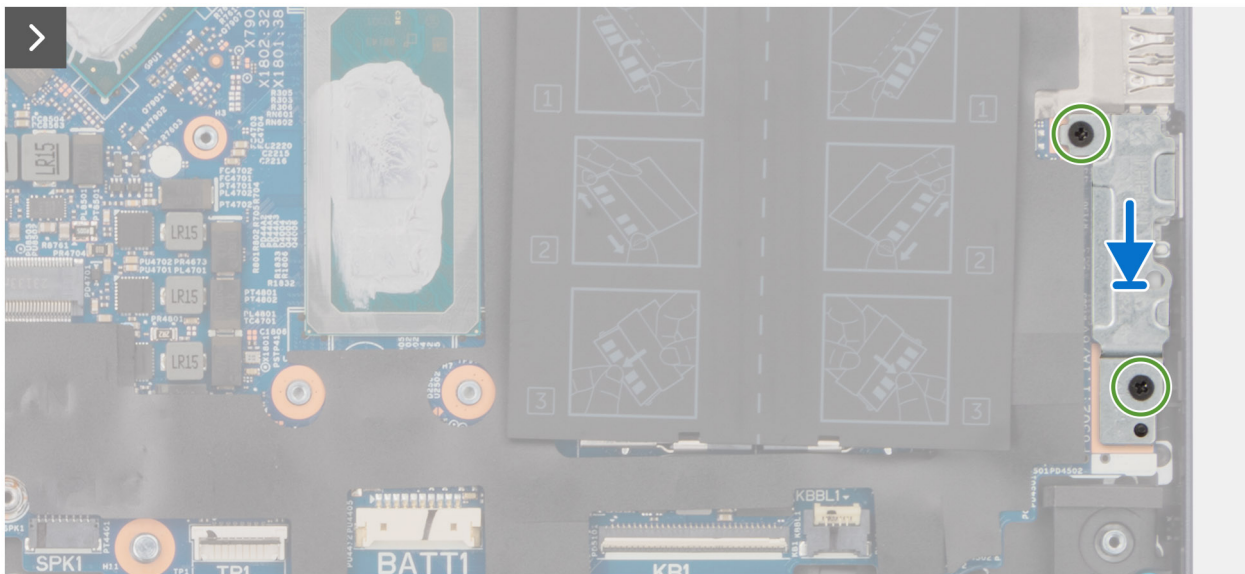

Figure 106. Replacing the USB Type-C bracket

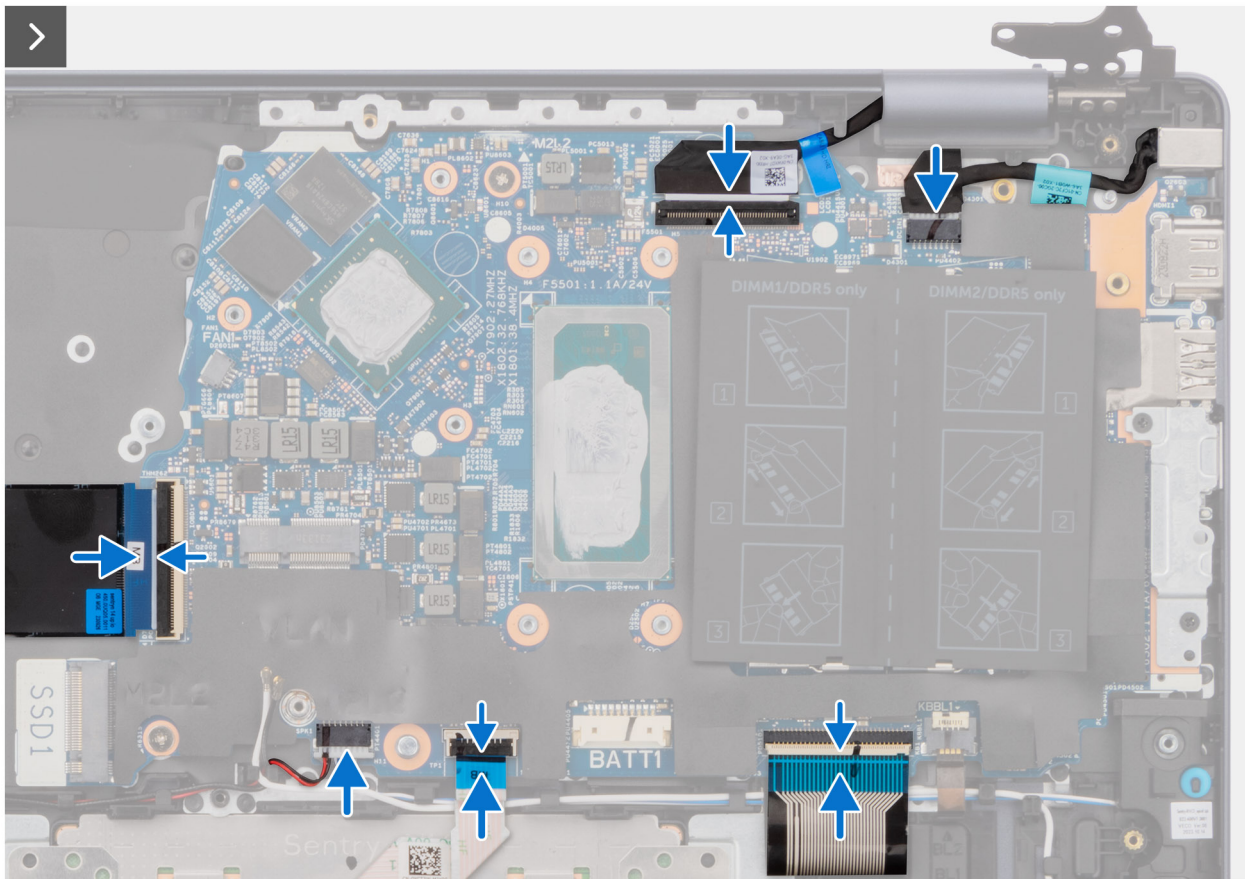

Figure 107. Replacing the cable connectors

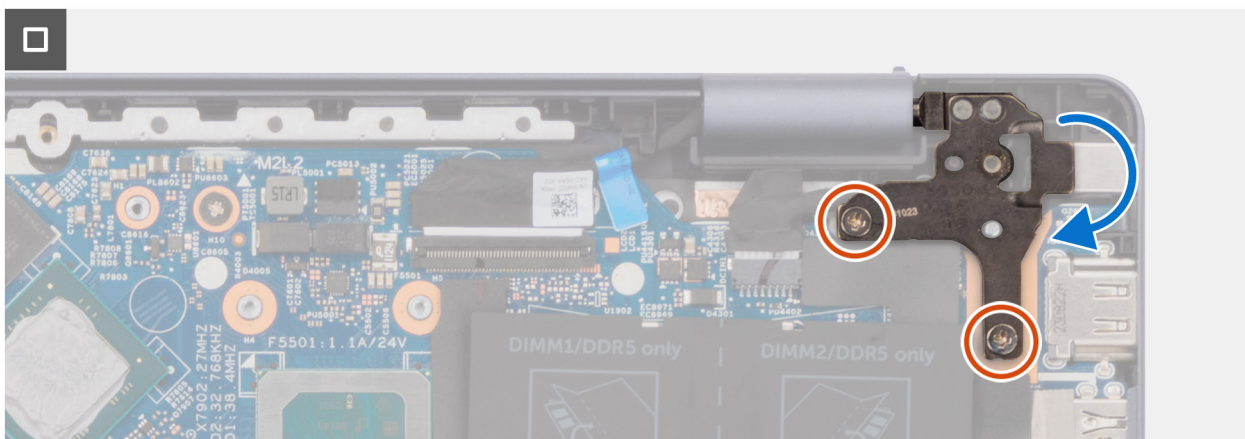

Figure 108. Replacing the hinge screws

### Steps

1. Align the screw holes on the system board with the screw holes on the palm-rest and keyboard assembly.
2. Replace the two screws (M2x2) that secure the system board to the palm-rest and keyboard assembly.
3. Align the screw holes on the USB Type-C bracket to the screw holes on the system board.
4. Replace the two screws (M2x4) that secure the USB Type-C bracket to the system board.
5. Connect the I/O board cable to the connector (IOBD1) on the system board.
6. Connect the speaker cable to the connector (SPK1) on the speaker board.
7. Connect the touchpad cable to the connector (TP1) system board and close the latch.
8. Connect the keyboard cable to the connector (KB1) system board and close the latch.

9. Connect the keyboard-backlight cable to the connector (KBBL1) system board and close the latch.
10. Rotate to close the right hinge.
11. Replace the two screws (M2.5x4.5) to secure the right hinge to the system board.

### Next steps

1. Install the [display assembly for computers shipped with an aluminum chassis](#).
2. Install the [heatsink](#).

**NOTE:** The system board can be removed and installed along with the heat sink, when you replace the palm-rest and keyboard assembly. This simplifies the removal and installation procedure and prevents damage to the thermal bond between the system board and heat sink.

3. Install the [fan for computers shipped with an aluminum chassis](#).
4. Install the [M.2 2230 solid-state drive for computers shipped with an aluminum chassis](#).
5. Install the [wireless card for computers shipped with an aluminum chassis](#).
6. Install the [54 W battery for computers shipped with an aluminum chassis](#).
7. Install the [base cover for computer shipped with an aluminum chassis](#).
8. Follow the procedure in [After working inside your computer](#).

## Palm-rest and keyboard assembly

### Removing the palm-rest and keyboard assembly for computers shipped with a plastic chassis

**CAUTION:** The information in this section is intended for authorized service technicians only.

#### Prerequisites

1. Follow the procedure in [Before working inside your computer](#).

**NOTE:** Ensure that your computer is in Service Mode. For more information see, [Before working inside your computer](#).

2. Remove the [base cover for computers shipped with a plastic chassis](#).
3. Remove the [battery for computers shipped with a plastic chassis](#).
4. Remove the [wireless card for computers shipped with a plastic chassis](#).
5. Remove the [M.2 2230 solid-state drive for computers shipped with a plastic chassis](#).
6. Remove the [I/O board for computers shipped with a plastic chassis](#).
7. Remove the [speakers for computers shipped with a plastic chassis](#).
8. Remove the [fan for computers shipped with a plastic chassis](#).
9. Remove the [heatsink](#).

**NOTE:** The system board can be removed and installed along with the heat sink, when you replace the palm-rest and keyboard assembly. This simplifies the removal and installation procedure and prevents damage to the thermal bond between the system board and heat sink.

10. Remove the [power button for computers shipped with a plastic chassis](#).
11. Remove the [touchpad for computers shipped with a plastic chassis](#).
12. Remove the [display assembly for computers shipped with a plastic chassis](#).
13. Remove the [system board for computers shipped with a plastic chassis](#).

#### About this task

The following image indicates the location of the palm-rest and keyboard assembly and provides a visual representation of the removal procedure.

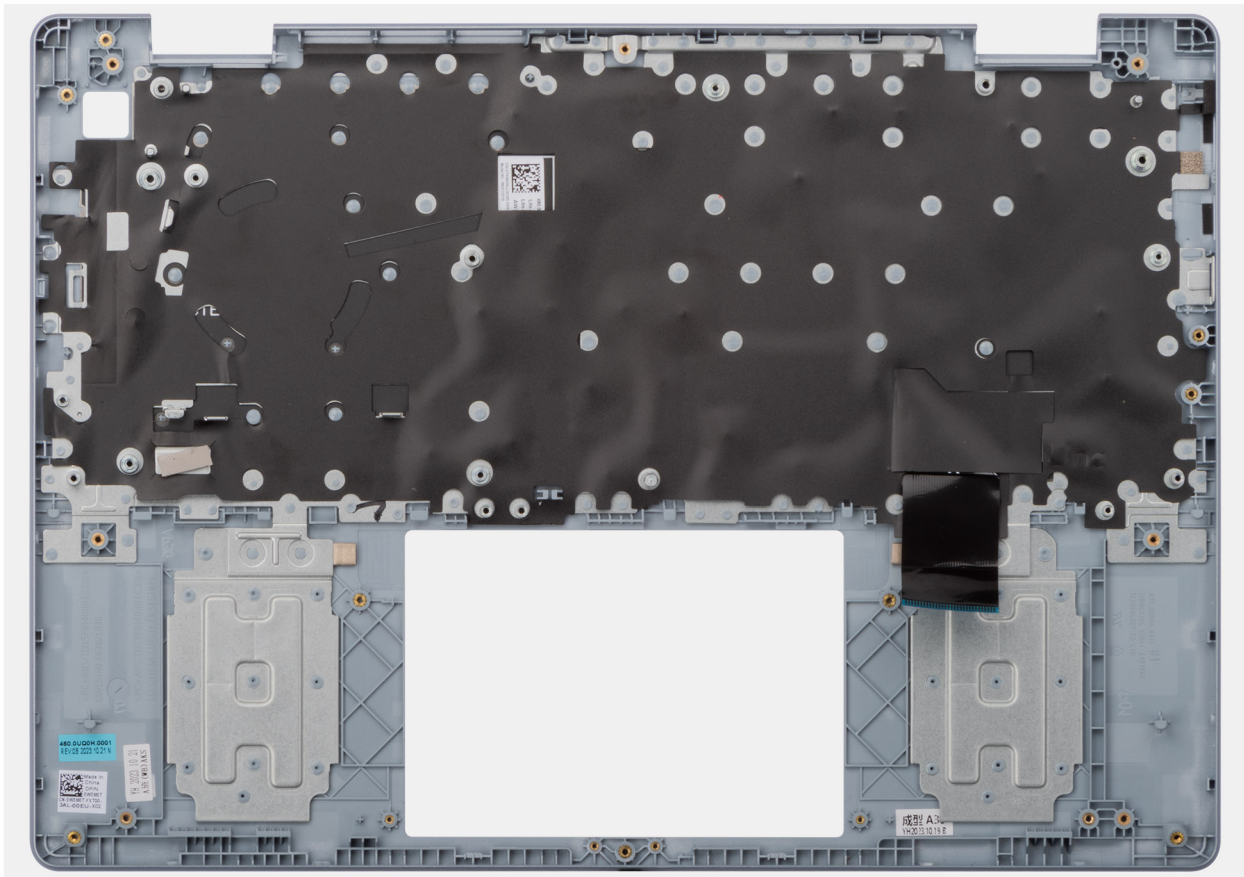

**Figure 109. Removing the palm-rest and keyboard assembly**

### Steps

After performing the steps in the pre-requisites, you are left with the palm-rest and keyboard assembly.

## Installing the palm-rest and keyboard assembly for computers shipped with a plastic chassis

**CAUTION:** The information in this section is intended for authorized service technicians only.

### Prerequisites

If you are replacing a component, remove the existing component before performing the installation procedure.

### About this task

The following image indicates the location of the palm-rest and keyboard assembly and provides a visual representation of the installation procedure.

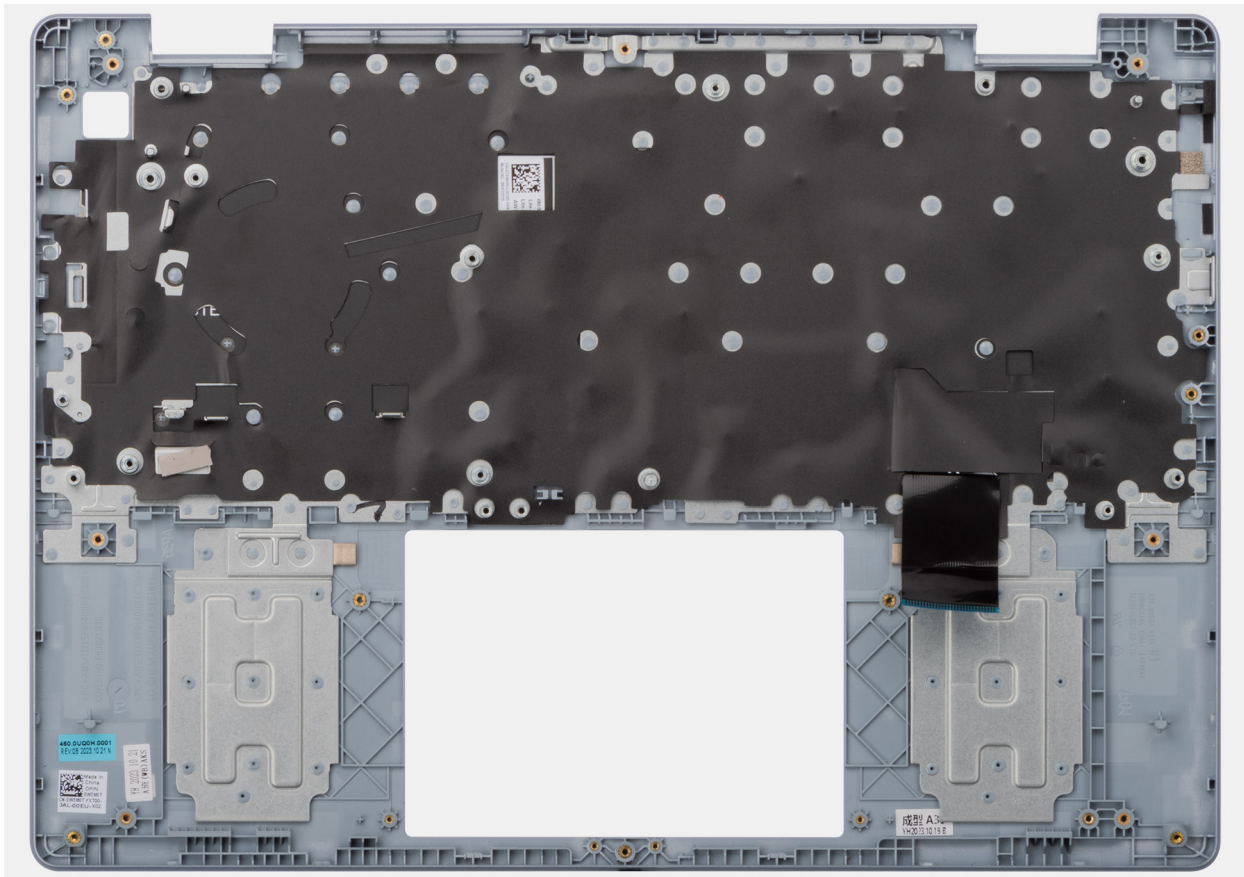

**Figure 110. Installing the palm-rest and keyboard assembly**

### Steps

Place the palm-rest and keyboard assembly on a clean and flat surface.

### Next steps

1. Install the [system board](#) for computers shipped with a plastic chassis.
2. Install the [display assembly](#) for computers shipped with a plastic chassis.
3. Install the [touchpad](#) for computers shipped with a plastic chassis.
4. Install the [power button](#) for computers shipped with a plastic chassis.
5. Install the [heatsink](#).
6. Install the [fan](#) for computers shipped with a plastic chassis.
7. Install the [speakers](#) for computers shipped with a plastic chassis.
8. Install the [I/O board](#) for computers shipped with a plastic chassis.
9. Install the [M.2 2230 solid-state drive](#) for computers shipped with a plastic chassis.
10. Install the [wireless card](#) for computers shipped with a plastic chassis.
11. Install the [battery](#) for computers shipped with a plastic chassis.
12. Install the [base cover](#) for computers shipped with a plastic chassis.
13. Follow the procedure in [After working inside your computer](#).

## Removing the palm-rest and keyboard assembly for computers shipped with an aluminum chassis

**CAUTION:** The information in this section is intended for authorized service technicians only.

## Prerequisites

1. Follow the procedure in [Before working inside your computer](#).

**NOTE:** Ensure that your computer is in Service Mode. For more information see, [Before working inside your computer](#).

2. Remove the [base cover for computers shipped with an aluminum chassis](#).
3. Remove the [54 W battery for computers shipped with an aluminum chassis](#).
4. Remove the [wireless card for computers shipped with an aluminum chassis](#).
5. Remove the [M.2 2230 solid-state drive for computers shipped with an aluminum chassis](#).
6. Remove the [I/O board for computers shipped with an aluminum chassis](#).
7. Remove the [speakers for computers shipped with an aluminum chassis](#).
8. Remove the [fan for computers shipped with an aluminum chassis](#).
9. Remove the [heatsink](#).

**NOTE:** The system board can be removed and installed along with the heat sink, when you replace the palm-rest and keyboard assembly. This simplifies the removal and installation procedure and prevents damage to the thermal bond between the system board and heat sink.

10. Remove the [power button with fingerprint reader for computers shipped with an aluminum chassis](#).
11. Remove the [touchpad for computers shipped with an aluminum chassis](#).
12. Remove the [display assembly for computers shipped with an aluminum chassis](#).
13. Remove the [system board for computers shipped with an aluminum chassis](#).

## About this task

The following image indicates the location of the palm-rest and keyboard assembly and provides a visual representation of the removal procedure.

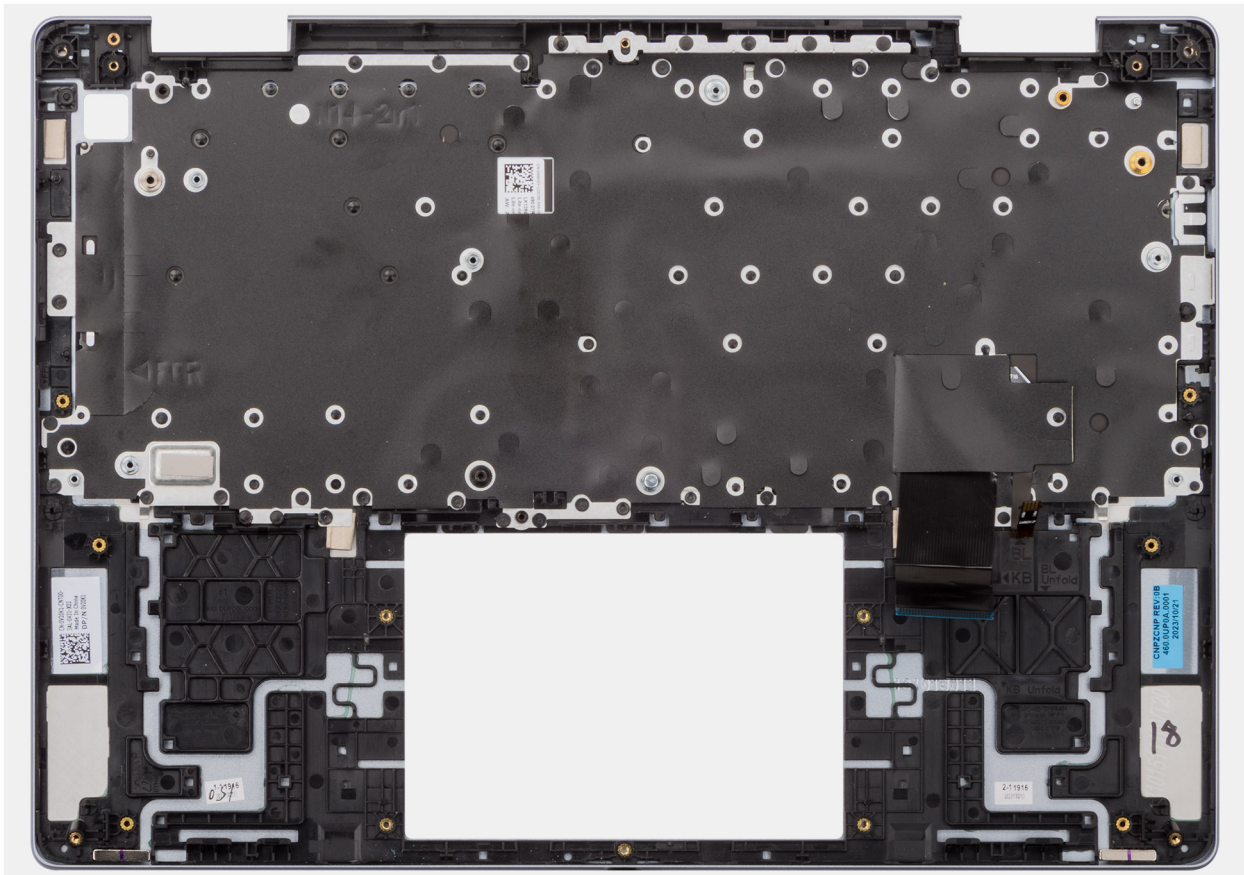

Figure 111. Removing the palm-rest and keyboard assembly

## Steps

After performing the steps in the pre-requisites, you are left with the palm-rest and keyboard assembly.

# Installing the palm-rest and keyboard assembly for computers shipped with an aluminum chassis

**CAUTION:** The information in this section is intended for authorized service technicians only.

## Prerequisites

If you are replacing a component, remove the existing component before performing the installation procedure.

## About this task

The following image indicates the location of the palm-rest and keyboard assembly and provides a visual representation of the installation procedure.

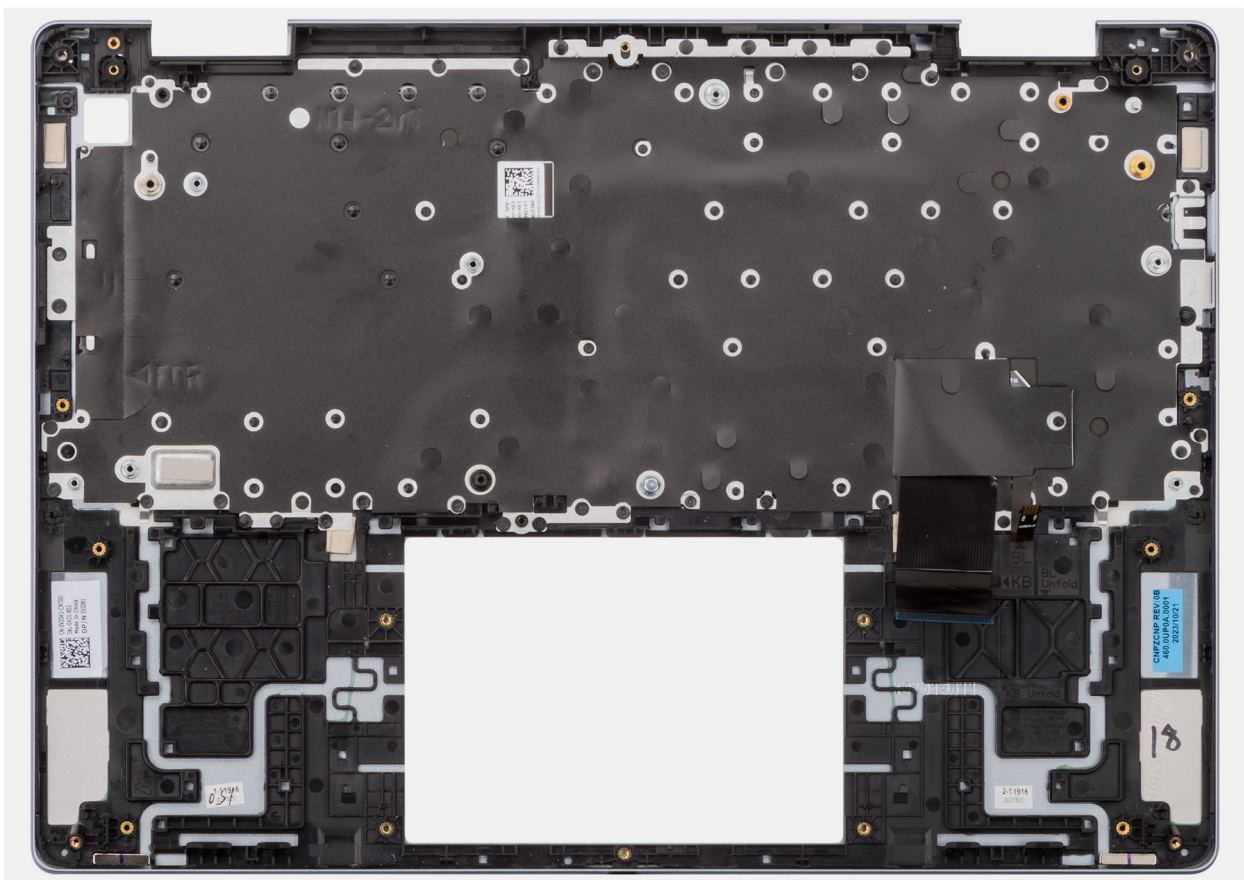

**Figure 112. Installing the palm-rest and keyboard assembly**

## Steps

Place the palm-rest and keyboard assembly on a clean and flat surface.

## Next steps

1. Install the [system board for computers shipped with an aluminum chassis](#).
2. Install the [display assembly for computers shipped with an aluminum chassis](#).
3. Install the [touchpad for computers shipped with an aluminum chassis](#).
4. Install the [power button with fingerprint reader for computers shipped with an aluminum chassis](#).
5. Install the [heatsink](#) .

**i** **NOTE:** The system board can be removed and installed along with the heat sink, when you replace the palm-rest and keyboard assembly. This simplifies the removal and installation procedure and prevents damage to the thermal bond between the system board and heat sink.

6. Install the [fan](#) for computers shipped with an aluminum chassis.
7. Install the [speakers](#) for computers shipped with an aluminum chassis.
8. Install the [I/O board](#) for computers shipped with an aluminum chassis.
9. Install the [M.2 2230 solid-state drive](#) for computers shipped with an aluminum chassis.
10. Install the [wireless card](#) for computers shipped with an aluminum chassis.
11. Install the [54 W battery](#) for computers shipped with an aluminum chassis.
12. Install the [base cover](#) for computer shipped with an aluminum chassis.
13. Follow the procedure in [After working inside your computer](#).



# Software

This chapter details the supported operating systems along with instructions on how to install the drivers.

## Operating system

Your Dell Pro 14 Essential PV14250 supports the following operating systems:

- Windows 11 Home
- Windows 11 Pro
- Windows 11 Pro National Academic
- Ubuntu Linux 22.04 LTS, 64-bit

## Drivers and downloads

When troubleshooting, downloading, or installing drivers, it is recommended that you read the [Dell Knowledge Base article Drivers and Downloads FAQs](#).

# BIOS Setup

**CAUTION:** Certain changes can make your computer work incorrectly. Before you change the settings in BIOS Setup, it is recommended that you note down the original settings for future reference.

**NOTE:** Depending on the computer and the installed devices, the options that are listed in this section may differ.

Use BIOS Setup for the following purposes:

- Get information about the hardware installed in your computer, such as the amount of RAM and the capacity of the storage device.
- Change the system configuration information.
- Set or change user-selectable options such as the user password, enabling or disabling base devices, and configuring hard drive settings.

## Entering BIOS Setup program

Turn on or restart your computer and press F2 immediately.

## Navigation keys

**NOTE:** For most of the BIOS Setup options, changes that you make are recorded but do not take effect until you restart the computer.

**Table 32. Navigation keys**

| Keys       | Navigation   |
|------------|--|
| Up arrow   | Moves to the previous field.   |
| Down arrow | Moves to the next field.   |
| Enter      | Selects a value in the selected field (if applicable) or follows the link in the field.  |
| Spacebar   | Expands or collapses a drop-down list, if applicable.  |
| Tab        | Moves to the next focus area.  |
| Esc        | Moves to the previous page until you view the main screen. Pressing Esc in the main screen displays a message that prompts you to save any unsaved changes and restart the computer. |

## F12 One Time Boot menu

To enter the One Time Boot menu, turn on or restart your computer, and then press F12 immediately.

**NOTE:** If you are unable to enter the One Time Boot menu, repeat the above action.

The One Time Boot menu displays the devices that you can boot from and also display the options to start diagnostics. The boot menu options are:

- Removable Drive (if available)
- STXXXX Drive (if available)

 **NOTE:** XXX denotes the SATA drive number.

- Optical Drive (if available)
- SATA Hard Drive (if available)
- Diagnostics

The One Time Boot menu screen also displays the option to access BIOS Setup.

## System setup options

 **NOTE:** Depending on your computer and its installed devices, the items that are listed in this section may or may not be displayed.

**Table 33. System setup options—Overview menu**

| <b>Overview</b>               |  |
|-------------------------------|--|
| Dell Pro 14 Essential PV14250 |  |
| BIOS Version                  | Displays the BIOS version number.  |
| Service Tag                   | Displays the Service Tag of the computer.  |
| Asset Tag                     | Displays the Asset Tag of the computer.  |
| Manufacture Date              | Displays the manufacture date of the computer.   |
| Ownership Date                | Displays the ownership date of the computer.   |
| Express Service Code          | Displays the Express Service Code of the computer.   |
| Ownership Tag                 | Displays the Ownership Tag of the computer.  |
| Signed Firmware Update        | Displays whether the Signed Firmware Update is enabled on your computer.<br>By default, the <b>Signed Firmware Update</b> option is enabled. |
| <b>Battery</b>                |  |
| Primary                       | Displays the primary battery of the computer.  |
| Battery Level                 | Displays the battery level of the computer.  |
| Battery State                 | Displays the battery state of the computer.  |
| Health                        | Displays the battery health of the computer.   |
| AC Adapter                    | Displays whether an AC adapter is connected. If connected, displays the type of AC adapter that is connected.                                |
| <b>Processor</b>              |  |
| Processor Type                | Displays the processor type.   |
| Maximum Clock Speed           | Displays the maximum processor clock speed.  |
| Minimum Clock Speed           | Displays the minimum processor clock speed.  |
| Current Clock Speed           | Displays the current processor clock speed.  |
| Core Count                    | Displays the number of cores on the processor.   |
| Processor ID                  | Displays the processor identification code.  |
| Processor L2 Cache            | Displays the processor L2 Cache size.  |
| Processor L3 Cache            | Displays the processor L3 Cache size.  |
| Microcode Version             | Displays the microcode version.  |
| Intel Hyper-Threading Capable | Displays whether the processor is Hyper-Threading (HT) capable.  |



**Table 33. System setup options—Overview menu (continued)**

| <b>Overview</b>     |  |
|---------------------|--|
| 64-Bit Technology   | Displays whether 64-bit technology is used.                  |
| <b>Memory</b>       |  |
| Memory Installed    | Displays the total computer memory installed.                |
| Memory Available    | Displays the total computer memory available.                |
| Memory Speed        | Displays the memory speed.                                   |
| Memory Channel Mode | Displays single or dual channel mode.                        |
| Memory Technology   | Displays the technology that is used for the memory.         |
| DIMM_SLOT1          | Displays the memory installed and memory type in DIMM SLOT1. |
| DIMM_SLOT2          | Displays the memory installed and memory type in DIMM SLOT2. |
| <b>Devices</b>      |  |
| Panel Type          | Displays the Panel Type of the computer.                     |
| Video Controller    | Displays the video controller type of the computer.          |
| Video Memory        | Displays the video memory information of the computer.       |
| Wi-Fi Device        | Displays the wireless device information of the computer.    |
| Native Resolution   | Displays the native resolution of the computer.              |
| Video BIOS Version  | Displays the video BIOS version of the computer.             |
| Audio Controller    | Displays the audio controller information of the computer.   |
| Bluetooth Device    | Displays the Bluetooth device information of the computer.   |
| LOM MAC Address     | Displays the MAC address of the computer.                    |

**Table 34. System setup options—Boot Configuration menu**

| <b>Boot Configuration</b>     |   |
|-------------------------------|---|
| <b>Boot Sequence</b>          |   |
| Boot Mode: UEFI only          | Displays the boot mode of the computer.   |
| Boot Sequence                 | Displays the boot sequence.   |
| Enable PXE Boot Priority      | Enables adding new PXE boot options to the top of the Boot Sequence.<br>By default, the <b>Enable PXE Boot Priority</b> option is disabled.   |
| Secure Digital (SD) Card Boot | Enables or disables read-only boot from Secure Digital (SD) card.<br>By default, the <b>Secure Digital (SD) Card Boot</b> option is disabled.   |
| <b>Secure Boot</b>            |   |
|                               | Secure Boot is a method of guaranteeing the integrity of the boot path by performing additional validation of the operating system and PCI add-in cards. The computer stops booting to the operating system when a component is not authenticated during the boot process. Secure Boot can be enabled in BIOS setup or using management interfaces like Dell Command Configure, but can only be disabled from BIOS setup. |
| Enable Secure Boot            | Enables the computer to boot using only validated boot software.<br>By default, the <b>Enable Secure Boot</b> option is enabled.<br><br>For additional security, Dell Technologies recommends keeping the <b>Secure Boot</b> option enabled to ensure that the UEFI firmware validates the operating system during the boot process.  |

**Table 34. System setup options—Boot Configuration menu (continued)**

| <b>Boot Configuration</b>    |  |
|------------------------------|--|
|                              | <p> <b>NOTE:</b> For Secure Boot to be enabled, the computer is required to be in UEFI boot mode and the Enable Legacy Option ROMs option is required to be turned off.</p>   |
| Enable Microsoft UEFI CA     | <p>When disabled, the UEFI CA is removed from the BIOS UEFI Secure Boot database ('db' variable).</p> <p> <b>CAUTION:</b> If you disable Microsoft UEFI CA, the computer may not boot, computer graphics may not function, some devices may not function properly, and the computer could become unrecoverable.</p> <p>Microsoft HLK requirements for DeviceGuard require the UEFI 3<sup>rd</sup> Party CA removal from the UEFI SecureBoot database (db).</p> <p>Setting this option to Allow Pre-Boot Modules Only, will allow the UEFI 3<sup>rd</sup> party CA to be used to validate pre-boot option ROMs, but will not allow a bootloder signed with the UEFI 3<sup>rd</sup> party CA to be loaded.</p> <p>For additional security, Dell Technologies recommends setting the Microsoft UEFI CA option to <b>Enabled</b> to ensure the broadest compatibility with devices and operating systems.</p> |
| Secure Boot Mode             | <p>Enables or disables the Secure Boot operation mode.</p> <p>By default, the <b>Deployed Mode</b> is selected.</p> <p> <b>NOTE:</b> <b>Deployed Mode</b> should be selected for normal operation of Secure Boot.</p>   |
| <b>Expert Key Management</b> |  |
| Enable Custom Mode           | <p>Enables or disables the keys in the PK, KEK, db, and dbx security key databases to be modified.</p> <p>By default, the <b>Enable Custom Mode</b> option is disabled.</p>  |
| Custom Mode Key Management   | <p>Selects the custom values for expert key management.</p> <p>By default, the <b>PK</b> option is selected.</p>   |

**Table 35. System setup options—Integrated Devices menu**

| <b>Integrated Devices</b> |   |
|---------------------------|---|
| <b>Date/Time</b>          |   |
| Date                      | Sets the computer date in MM/DD/YYYY format. Changes to the date format take effect immediately.  |
| Time                      | Sets the computer time in HH/MM/SS 24-hour format. You can switch between a 12-hour and 24-hour clock. Changes to the time format take effect immediately.  |
| <b>Camera</b>             |   |
| Enable Camera             | <p>Enables the camera.</p> <p>By default, the <b>Enable Camera</b> option is enabled.</p> <p> <b>NOTE:</b> Depending on the configuration ordered, the camera setup option may not be available.</p> |
| <b>Audio</b>              |   |
| Enable Audio              | <p>Enables all integrated audio controller.</p> <p>By default, all the options are enabled.</p>   |
| Enable Microphone         | Enables the microphone.   |

**Table 35. System setup options—Integrated Devices menu (continued)**

| <b>Integrated Devices</b>        |   |
|----------------------------------|---|
|                                  | By default, the <b>Enable Microphone</b> option is enabled.<br> <b>NOTE:</b> Depending on the configuration ordered, the microphone setup option may not be available. |
| Enable Internal Speaker          | Enables the internal speaker.<br>By default, the <b>Enable Internal Speaker</b> option is enabled.  |
| <b>USB Configuration</b>         |   |
| Enable External USB Ports        | Enables the external USB ports.<br>By default, the <b>Enable External USB Ports</b> option is enabled.  |
| Enable USB Boot Support          | Enables booting from USB mass storage devices that are connected to external USB ports.<br>By default, the <b>Enable USB Boot Support</b> option is enabled.  |
| <b>Miscellaneous Devices</b>     |   |
| Enable Fingerprint Reader Device | Enables the Fingerprint Reader Device option.<br>By default, the <b>Enable Fingerprint Reader Device</b> option is enabled.   |

**Table 36. System setup options—Storage menu**

| <b>Storage</b>                              |  |
|---|--|
| <b>SATA/NVMe Operation</b>                  |  |
| SATA/NVMe Operation                         | Sets the operating mode of the integrated SATA hard drive controller.<br>By default, the <b>RAID On</b> option is selected. The storage device is configured to support RAID functions with VMD controller.  |
| <b>Storage Interface</b>                    |  |
| Port Enablement                             | Displays the information of various onboard drives.<br>Enables or disables the M.2 PCIe SSD option.<br>By default, the <b>M.2 PCIe SSD</b> option is enabled.  |
| <b>SMART Reporting</b>                      |  |
| Enable SMART Reporting                      | Enables SMART (Self-Monitoring, Analysis, and Reporting Technology) Reporting.<br>When enabled, the BIOS can receive analytical information from integrated drives and send notifications during startup about possible future failure of the hard drive.<br>By default, the <b>Enable SMART Reporting</b> option is disabled. |
| <b>Drive Information</b>                    |  |
| Displays the information of onboard drives. |  |
| <b>Enable MediaCard</b>                     |  |
| Secure Digital (SD) Card                    | Enables or disables the SD card.<br>By default, the <b>Secure Digital (SD) Card</b> option is enabled.   |

**Table 37. System setup options—Display menu**

| <b>Display</b>              |   |
|-----------------------------|---|
| <b>Display Brightness</b>   |   |
| Brightness on battery power | Enables to set the screen brightness when the computer is running on battery power. |

**Table 37. System setup options—Display menu (continued)**

| <b>Display</b>          |   |
|-------------------------|---|
|                         | By default, the screen brightness is set to 50 when the computer is running on battery power.   |
| Brightness on AC power  | Enables to set the screen brightness when the computer is running on AC power.<br>By default, the screen brightness is set to 100 when the computer is running on AC power. |
| <b>Full Screen Logo</b> | Enables or disables the computer to display a full-screen logo, if the image matches screen resolution.<br><br>By default, the <b>Full Screen Logo</b> option is disabled.  |

**Table 38. System setup options—Connection menu**

| <b>Connection</b>                       |   |
|---|---|
| <b>Network Controller Configuration</b> |   |
| Integrated NIC                          | Enables or disables the on-board LAN Controller.<br>By default, the <b>Enabled with PXE</b> option is selected.   |
| <b>Wireless Device Enable</b>           |   |
| WLAN                                    | Enables or disables the internal WLAN device.<br>By default, the <b>WLAN</b> option is enabled.   |
| Bluetooth                               | Enables or disables the internal Bluetooth device.<br>By default, the <b>Bluetooth</b> option is enabled.   |
| <b>Enable UEFI Network Stack</b>        | Enables or disables the UEFI Network Stack and controls the onboard LAN Controller.<br>By default, the <b>Auto Enabled</b> option is selected.  |
| <b>HTTP(s) Boot Feature</b>             |   |
| HTTP(s) Boot                            | Displays if the computer has HTTP(s) Boot capabilities or not.<br>By default, the <b>HTTP(s) Boot</b> option is enabled.  |
| HTTP(s) Boot Modes                      | Allows you to set the HTTP(s) Boot Mode for the computer.<br>By default, the <b>Auto Mode</b> option is selected. HTTP(s) Boot automatically extracts Boot URL from Dynamic Host Configuration Protocol (DHCP). |

**Table 39. System setup options—Power menu**

| <b>Power</b>                                 |   |
|--|---|
| <b>Battery Configuration</b>                 | Enables or disables the computer to run on battery during peak power usage hours. Use the table <b>Custom Charge Start</b> and <b>Custom Charge Stop</b> , to prevent AC power usage between certain times of each day.<br><br>By default, the <b>Adaptive</b> option is selected. Battery settings are adaptively optimized based on your typical battery usage pattern. |
| <b>Advanced Configuration</b>                |   |
| Enable Advanced Battery Charge Configuration | Enables Advanced Battery Charge Configuration from the beginning of the day to a specified work period. When enabled, Advanced Battery Charged maximizes battery health while still supporting heavy use during the work day.<br><br>By default, the <b>Enable Advanced Battery Charge Configuration</b> option is disabled.  |

**Table 39. System setup options—Power menu (continued)**



| Power                               |  |
|-------------------------------------|--|
| <b>Thermal Management</b>           | <p>Enables or disables cooling of fan and manages processor heat to adjust the computer performance, noise, and temperature.</p> <p>By default, the <b>Optimized</b> option is selected. Standard setting for balanced performance, noise, and temperature.</p>  |
| <b>USB Wake Support</b>             |  |
| Wake on Dell USB-C Dock             | <p>When enabled, connecting a Dell USB-C Dock wakes the computer from Standby, Hibernate, and Power Off.</p> <p>By default, the <b>Wake on Dell USB-C Dock</b> option is enabled.</p>  |
| <b>Block Sleep</b>                  | <p>Enables or disables the computer from entering Sleep (S3) mode in the operating system.</p> <p>By default, the <b>Block Sleep</b> option is disabled.</p> <p><b>i</b> <b>NOTE:</b> When enabled, the computer does not go to Sleep, Intel Rapid Start is disabled automatically, and the operating system power option is blank if it was set to Sleep.</p> |
| <b>Intel Speed Shift Technology</b> | <p>Enables or disables the Intel Speed Shift Technology support. When enabled, the operating system selects the appropriate processor performance automatically.</p> <p>By default, the <b>Intel Speed Shift Technology</b> option is enabled.</p>   |

**Table 40. System setup options—Security menu**

| Security  |   |
|---|---|
| <b>Trusted Platform Module (TPM) 2.0 Security</b> | <p>The Trusted Platform Module (TPM) provides various cryptographic services which serve as the cornerstone for many platform security technologies. Trusted Platform Module (TPM) is a security device that stores computer-generated keys for encryption and features such as BitLocker, Virtual Secure Mode, remote Attestation.</p> <p>By default, the <b>Trusted Platform Module (TPM)</b> option is enabled.</p> <p>For additional security, Dell Technologies recommends keeping <b>Trusted Platform Module (TPM)</b> enabled to allow these security technologies to fully function.</p> <p><b>i</b> <b>NOTE:</b> The options that are listed apply to computers with a discrete <b>Trusted Platform Module (TPM)</b> chip.</p> |
| TPM 2.0 Security On                               | <p>Allows you to select whether or not the TPM is visible to the operating system.</p> <p>By default, the <b>TPM 2.0 Security On</b> option is enabled.</p> <p>For additional security, Dell Technologies recommends keeping <b>TPM 2.0 Security On</b> enabled to allow these security technologies to fully function.</p>   |
| Attestation Enable                                | <p>The <b>Attestation Enable</b> option controls the endorsement hierarchy of TPM. Disabling the <b>Attestation Enable</b> option prevents TPM from being used to digitally sign certificates.</p> <p>By default, the <b>Attestation Enable</b> option is enabled.</p> <p>For additional security, Dell Technologies recommends keeping the <b>Attestation Enable</b> option enabled.</p> <p><b>i</b> <b>NOTE:</b> When disabled, this feature may cause compatibility issues or loss of functionality in some operating systems.</p>   |
| Key Storage Enable                                | <p>The <b>Key Storage Enable</b> option controls the storage hierarchy of TPM, which is used to store digital keys. Disabling the <b>Key Storage Enable</b> option restricts the ability of TPM to store owner's data.</p>  |



**Table 40. System setup options—Security menu (continued)**

| <b>Security</b>   |   |
|---|---|
|   | <p>By default, the <b>Key Storage Enable</b> option is enabled.</p> <p>For additional security, Dell Technologies recommends keeping the <b>Key Storage Enable</b> option enabled.</p> <p> <b>NOTE:</b> When disabled, this feature may cause compatibility issues or loss of functionality in some operating systems.</p>   |
| SHA-256   | <p>Allows you to control the hashing algorithm that is used by the TPM. When enabled, the TPM uses the SHA-256 hashing algorithm. When disabled, the TPM uses the SHA-1 hash algorithm.</p> <p>By default, the <b>SHA-256</b> option is enabled.</p> <p>For additional security, Dell Technologies recommends keeping the <b>SHA-256</b> option enabled.</p>  |
| Clear   | <p>When enabled, the <b>Clear</b> option clears information that is stored in the TPM after exiting the computer's BIOS. This option returns to the disabled state when the computer restarts.</p> <p>By default, the <b>Clear</b> option is disabled.</p> <p>Dell Technologies recommends enabling the <b>Clear</b> option only when TPM data is required to be cleared.</p>   |
| Physical Presence Interface (PPI) Bypass for Clear Commands | <p>By default, the <b>PPI Bypass for Clear Commands</b> option is disabled.</p> <p>For additional security, Dell Technologies recommends keeping the <b>PPI Bypass for Clear Commands</b> option disabled.</p>  |
| <b>SMM Security Mitigation</b>                              | <p>Enables or disables additional UEFI SMM Security Mitigation protections. This option uses the Windows SMM Security Mitigations Table (WSMT) to confirm to the operating system that security best practices have been implemented by the UEFI firmware.</p> <p>By default, the <b>SMM Security Mitigation</b> option is enabled.</p> <p>For additional security, Dell Technologies recommends keeping the <b>SMM Security Mitigation</b> option enabled unless you have a specific application which is not compatible.</p> <p> <b>NOTE:</b> This feature may cause compatibility issues or loss of functionality with some legacy tools and applications.</p>  |
| <b>Data Wipe on Next Boot</b>                               |   |
| Start Data Wipe   | <p>Data Wipe is a secure wipe operation that deletes information from a storage device.</p> <p> <b>CAUTION: The secure Data Wipe operation deletes information in a way that it cannot be reconstructed.</b></p> <p>Commands such as delete and format in the operating system may remove files from showing up in the file system. However, they can be reconstructed through forensic means as they are still represented on the physical media. Data Wipe prevents this reconstruction and is not recoverable.</p> <p>When enabled, the data wipe option will prompt to wipe any storage devices that are connected to the computer on the next boot.</p> <p>By default, the <b>Start Data Wipe</b> option is disabled.</p> |
| Absolute  | <p>Absolute Software provides various cyber security solutions, some requiring software preloaded on Dell computers and integrated into the BIOS. To use these features, you must enable the Absolute BIOS setting and contact Absolute for configuration and activation.</p> <p>By default, the <b>Enable Absolute</b> option is selected.</p>   |

**Table 40. System setup options—Security menu (continued)**

| Security                |   |
|-------------------------|---|
|                         | <p>For additional security, Dell Technologies recommends selecting the <b>Enable Absolute</b> option.</p> <p> <b>NOTE:</b> When the Absolute features are activated, the Absolute integration cannot be disabled from the BIOS setup screen.</p> |
| UEFI Boot Path Security | <p>Enables or disables the computer to prompt the user to enter the Administrator password (if set) when booting to a UEFI boot path device from the F12 boot menu.</p> <p>By default, the <b>Always Except Internal HDD</b> option is enabled.</p>   |

**Table 41. System setup options—Passwords menu**

| Passwords              |   |
|------------------------|---|
| <b>Admin Password</b>  | <p>The Admin Password prevents unauthorized access to the BIOS Setup options. Once the administrator password is set, the BIOS setup options can only be modified after providing the correct password.</p> <p>The following rules and dependencies apply to the Admin Password -</p> <ul style="list-style-type: none"> <li>• The admin password cannot be set if computer and/or internal hard drive passwords are previously set.</li> <li>• The admin password can be used in place of the computer and/or internal hard drive passwords.</li> <li>• When set, the admin password must be provided during a firmware update.</li> <li>• Clearing the admin password also clears the computer password (if set).</li> </ul> <p>Dell Technologies recommends using an administrator password to prevent unauthorized changes to BIOS setup options.</p>   |
| <b>System Password</b> | <p>The System Password prevents the computer from booting to an operating system without entering the correct password.</p> <p>The following rules and dependencies apply when the System Password is used -</p> <ul style="list-style-type: none"> <li>• The computer shuts down when idle for approximately 10 minutes at the computer password prompt.</li> <li>• The computer shuts down after three incorrect attempts to enter the computer password.</li> <li>• The computer shuts down when the <b>Esc</b> key is pressed at the System Password prompt.</li> <li>• The computer password is not prompted when the computer resumes from standby mode.</li> </ul> <p>Dell Technologies recommends using the computer password in situations where it is likely that a computer may be lost or stolen.</p>   |
| <b>M.2 PCIe SSD-0</b>  | <p>The M.2 PCIe SSD-0 Password can be set to prevent unauthorized access of the data stored on the solid-state drive. The computer prompts for the solid-state drive password during boot in order to unlock the drive. A password-secured solid-state drive stays locked even when removed from the computer or placed into another computer. It prevents an attacker from accessing data on the drive without authorization.</p> <p>The following rules and dependencies apply when the M.2 PCIe SSD-0 Password is used -</p> <ul style="list-style-type: none"> <li>• The solid-state drive password option cannot be accessed when a hard drive is disabled in the BIOS setup.</li> <li>• The computer shuts down when idle for approximately 10 minutes at the solid-state drive password prompt.</li> <li>• The computer shuts down after three incorrect attempts to enter the solid-state drive password and treats the hard drive as not available.</li> </ul> |

**Table 41. System setup options—Passwords menu (continued)**

|                               |   |
|-------------------------------|---|
| <b>Passwords</b>              |   |
|                               | <ul style="list-style-type: none"> <li>• The solid-state drive does not accept password unlock attempts after five incorrect attempts to enter the solid-state drive password from the BIOS Setup. The solid-state drive password must be reset for the new password unlock attempts.</li> <li>• The computer treats the solid-state drive as not available when the <b>Esc</b> key is pressed at the solid-state drive password prompt.</li> <li>• The solid-state drive password is not prompted when the computer resumes from standby mode. When the solid-state drive is unlocked by the user before the computer goes into standby mode, it remains unlocked after the computer resumes from standby mode.</li> <li>• If the computer and solid-state drive passwords are set to the same value, the solid-state drive unlocks after the correct computer password is entered.</li> </ul> <p>Dell Technologies recommends using a solid-state drive password to protect unauthorized data access.</p> |
| <b>Password Configuration</b> | <p>The Password configuration page includes several options for changing the requirements of BIOS passwords. You can modify the minimum and maximum length of the passwords and require passwords to contain certain character classes (upper case, lower case, digit, special character).</p> <p>Dell Technologies recommends setting the minimum password length to at least eight characters.</p>  |
| Upper Case Letter             | <p>The Upper Case Letter field enforces stricter rules for administrator and system passwords.</p> <p>When enabled, the password is required to include at least one upper case letter.</p> <p>By default, the <b>Upper Case Letter</b> option is disabled.</p>   |
| Lower Case Letter             | <p>The Lower Case Letter field enforces stricter rules for administrator and system passwords.</p> <p>When enabled, the password is required to include at least one lower case letter.</p> <p>By default, the <b>Lower Case Letter</b> option is disabled.</p>   |
| Digit                         | <p>The Digit field enforces stricter rules for administrator and system passwords.</p> <p>When enabled, the password is required to include at least one digit number.</p> <p>By default, the <b>Digit</b> option is disabled.</p>  |
| Special Character             | <p>The Special Character field enforces stricter rules for administrator and system passwords.</p> <p>When enabled, the password is required to include at least one special character.</p> <p>By default, the <b>Special Character</b> option is disabled.</p>   |
| Minimum Characters            | <p>The Minimum Characters field enforces stricter rules for administrator and system passwords.</p> <p>It allows you to set the minimum number of characters allowed for password.</p> <p>By default, the <b>Minimum Characters</b> option is set to 04.</p>  |
| <b>Password Bypass</b>        | <p>The <b>Password Bypass</b> option allows the computer to reboot from the operating system without entering the computer or hard drive password. If the computer has already booted to the operating system, it is presumed that the user has already entered the correct computer or hard drive password.</p> <p> <b>NOTE:</b> This option does not remove the requirement to enter the password after shutting down.</p> <p>By default, the <b>Password Bypass</b> option is disabled.</p>   |

**Table 41. System setup options—Passwords menu (continued)**

| <b>Passwords</b>                   |   |
|------------------------------------|---|
|                                    | For additional security, Dell Technologies recommends keeping the <b>Password Bypass</b> option disabled.   |
| <b>Password Changes</b>            |   |
| Allow Non-Admin Password Changes   | <p>The <b>Allow Non-Admin Password Changes</b> option in BIOS setup allows an end user to set or change the computer or hard drive passwords without entering the administrator password. This gives an administrator control over the BIOS settings but enables an end user to provide their own password.</p> <p>By default, the <b>Allow Non-Admin Password Changes</b> option is enabled.</p> <p>For additional security, Dell Technologies recommends keeping the <b>Allow Non-Admin Password Changes</b> option enabled.</p>  |
| <b>Admin Setup Lockout</b>         |   |
|                                    | <p>The <b>Admin Setup Lockout</b> option prevents an end user from even viewing the BIOS setup configuration without first entering the administrator password (if set).</p> <p>By default, the <b>Admin Setup Lockout</b> option is disabled.</p> <p>For additional security, Dell Technologies recommends keeping the <b>Admin Setup Lockout</b> option disabled.</p>   |
| <b>Master Password Lockout</b>     |   |
| Enable Master Password Lockout     | <p>The Master Password Lockout setting allows you to disable the Recovery Password feature. If the computer, administrator, or hard drive password is forgotten, the computer becomes unusable.</p> <p><b>NOTE:</b> When an internal solid-state drive password is set, it must first be cleared before Master Password Lockout can be changed.</p> <p>By default, the <b>Enable Master Password Lockout</b> option is disabled.</p> <p>Dell Technologies does not recommend enabling the <b>Master Password Lockout</b> unless you have implemented your own password recovery computer.</p> |
| <b>Allow Non-Admin PSID Revert</b> |   |
| Enable Allow Non-Admin PSID Revert | <p>Allows you to control access to the Physical Security ID (PSID) revert of NVMe hard-drives from the Dell Security Manager prompt.</p> <p>When enabled, PSID revert is allowed to proceed without providing the BIOS Admin password.</p> <p>By default, the <b>Enable Allow Non-Admin PSID Revert</b> option is disabled.</p>   |

**Table 42. System setup options—Update, Recovery menu**

| <b>Update, Recovery</b>              |   |
|--------------------------------------|---|
| <b>UEFI Capsule Firmware Updates</b> |   |
| Enable UEFI Capsule Firmware Updates | <p>Enables or disables BIOS updates through UEFI capsule update packages.</p> <p><b>NOTE:</b> Disabling this option blocks the BIOS updates from services such as Microsoft Windows Update and Linux Vendor Firmware Service (LVFS).</p> <p>By default, the <b>Enable UEFI Capsule Firmware Updates</b> option is enabled.</p>  |
| <b>BIOS Recovery from Hard Drive</b> |   |
|                                      | <p>Enables or disables the user to recover from certain corrupted BIOS conditions from a recovery file on the user primary hard drive or an external USB key.</p> <p>By default, the <b>BIOS Recovery from Hard Drive</b> option is enabled.</p> <p><b>NOTE:</b> BIOS Recovery from Hard Drive is not available for self-encrypting drives (SED).</p> <p><b>NOTE:</b> BIOS recovery is designed to fix the main BIOS block and cannot work if the Boot Block is damaged. In addition, this feature cannot work in the</p> |

**Table 42. System setup options—Update, Recovery menu (continued)**

| Update, Recovery                |   |
|---------------------------------|---|
|                                 | event of EC corruption, ME corruption, or a hardware issue. The recovery image must exist on an unencrypted partition on the drive.   |
| BIOS Downgrade                  |   |
| Allow BIOS Downgrade            | Controls flashing of the computer firmware to previous revisions.<br>By default, the <b>Allow BIOS Downgrade</b> option is enabled.   |
| SupportAssist OS Recovery       |   |
|                                 | Enables or disables the boot flow for SupportAssist OS Recovery tool in the event of certain computer errors.<br>By default, the <b>SupportAssist OS Recovery</b> option is enabled.  |
| BIOSConnect                     |   |
|                                 | Enables or disables cloud Service operating system recovery if the main operating system fails to boot with the number of failures equal to or greater than the value specified by the Auto operating system Recovery Threshold setup option and local Service operating system does not boot or is not installed.<br>By default, the <b>BIOSConnect</b> option is enabled. |
| Dell Auto OS Recovery Threshold |   |
|                                 | Allows you to control the automatic boot flow for SupportAssist System Resolution Console and for Dell operating system Recovery Tool.<br>By default, the <b>Dell Auto OS Recovery Threshold</b> value is set to 2.   |

**Table 43. System setup options—System Management menu**

| System Management                     |   |
|---------------------------------------|---|
| Service Tag                           |   |
|                                       | Displays the Service Tag of the computer.   |
| Asset Tag                             |   |
|                                       | Creates a computer Asset Tag that can be used by an IT administrator to uniquely identify a particular computer.<br> <b>NOTE:</b> Once set in BIOS, the Asset Tag cannot be changed. |
| AC Behavior                           |   |
| Wake on AC                            | Enables or disables the computer to turn on and go to boot when AC power is supplied to the computer.<br>By default, the <b>Wake on AC</b> option is disabled.  |
| Auto On Time                          |   |
|                                       | Enable to set the computer to turn on automatically every day or on a preselected date and time. This option can be configured only if the Auto On Time is set to Everyday, Weekdays, or Selected Days.<br>By default, the <b>Auto On Time</b> option is disabled.      |
| Diagnostics                           |   |
| OS Agent Requests                     | Enables or disables the computer to turn on by a special LAN signal.<br>By default, the <b>OS Agent Requests</b> option is enabled.   |
| Power-on-Self-Test Automatic Recovery |   |
|                                       | Enables or disables the computer to turn on by a special LAN signal.<br>By default, the <b>Power-on-Self-Test Automatic Recovery</b> option is enabled.   |

**Table 44. System setup options—Keyboard menu**

| Keyboard        |  |
|-----------------|--|
| Fn Lock Options |  |
|                 | Enables or disables the Fn Lock option.<br>By default, the <b>Fn Lock</b> option is enabled. |

**Table 44. System setup options—Keyboard menu (continued)**

| Keyboard                                     |  |
|--|--|
| <b>Lock Mode</b>                             | By default, the <b>Lock Mode Secondary</b> option is enabled. With this option, the F1-F12 keys scan the code for their secondary functions.   |
| <b>Keyboard Illumination</b>                 | Configures the operating mode of the keyboard illumination feature.<br>By default, the <b>Bright</b> option is selected. Enables the keyboard illumination feature at 100% brightness level.   |
| <b>Keyboard Backlight Timeout on AC</b>      | Sets the timeout value for the keyboard backlight when an AC adapter is connected to the computer.<br>By default, the <b>1 minute</b> option is selected.  |
| <b>Keyboard Backlight Timeout on Battery</b> | Sets the timeout value for the keyboard backlight when the computer is running only on the battery power. The keyboard backlight timeout value is only effective when the backlight is enabled.<br>By default, the <b>1 minute</b> option is selected. |

**Table 45. System setup options—Pre-boot Behavior menu**

| Preboot Behavior             |   |
|------------------------------|---|
| <b>Adapter Warnings</b>      |   |
| Enable Adapter Warnings      | Enables the warning messages during boot when the adapters with less power capacity are detected.<br>By default, the <b>Enable Adapter Warnings</b> option is enabled.  |
| <b>Warnings and Errors</b>   | Enables or disables the action to be taken when a warning or error is encountered.<br>By default, the <b>Prompt on Warnings and Errors</b> option is selected. Stop, prompt, and wait for user input when warnings or errors are detected.<br><b>NOTE:</b> Errors deemed critical to the operation of the computer hardware stop the functioning of the computer. |
| <b>USB-C Warnings</b>        |   |
| Enable Dock Warning Messages | Enables the warning messages during boot when the USB-C adapters with less power capacity are detected.<br>By default, the <b>Enable Dock Warning Messages</b> option is enabled.   |
| <b>Extend BIOS POST Time</b> | Sets the BIOS POST (Power-On Self-Test) load time.<br>By default, the <b>0 seconds</b> option is selected.  |
| <b>Sign of Life</b>          |   |
| Early Keyboard Backlight     | Keyboard Backlight Sign of Life.<br>By default, the <b>Early Keyboard Backlight</b> option is enabled.  |

**Table 46. System setup options—Virtualization menu**

| Virtualization Support                      |  |
|---|--|
| <b>Intel Virtualization Technology</b>      |  |
| Enable Intel Virtualization Technology (VT) | When enabled, the computer can run a Virtual Machine Monitor (VMM).<br>By default, the <b>Enable Intel Virtualization Technology (VT)</b> option is enabled. |
| <b>VT for Direct I/O</b>                    |  |

**Table 46. System setup options—Virtualization menu (continued)**

| <b>Virtualization Support</b>        |  |
|--------------------------------------|--|
| Enable Intel VT for Direct I/O       | <p>When enabled, the computer can perform Virtualization Technology for Direct I/O (VT-d). VT-d is an Intel method that provides virtualization for memory map I/O.</p> <p>By default, the <b>Enable Intel VT for Direct I/O</b> option is enabled.</p>  |
| <b>DMA Protection</b>                |  |
| Enable Pre-Boot DMA Support          | <p>Allows you to control the Pre-Boot DMA protection for both internal and external ports. This option does not directly enable DMA protection in the operating system.</p> <p><b>NOTE:</b> This option is not available when the virtualization setting for IOMMU is disabled (VT-d/AMD Vi).</p> <p>By default, the <b>Enable Pre-Boot DMA Support</b> option is enabled.</p> <p>For additional security, Dell Technologies recommends keeping the <b>Enable Pre-Boot DMA Support</b> option enabled.</p> <p><b>NOTE:</b> This option is provided only for compatibility purposes, since some older hardware is not DMA capable.</p>  |
| Enable OS Kernel DMA Support         | <p>Allows you to control the Kernel DMA protection for both internal and external ports. This option does not directly enable DMA protection in the operating system. For operating systems that support DMA protection, this setting indicates to the operating system that the BIOS supports the feature.</p> <p><b>NOTE:</b> This option is not available when the virtualization setting for IOMMU is disabled (VT-d/AMD Vi).</p> <p>By default, the <b>Enable OS Kernel DMA Support</b> option is enabled.</p> <p><b>NOTE:</b> This option is provided only for compatibility purposes, since some older hardware is not DMA capable.</p>   |
| Internal Port DMA Compatibility Mode | <p>Allows you to control the boot compatibility for integrated PCIe peripherals by disabling PCIe DMA protection on internal PCIe ports.</p> <p>When enabled, BIOS will notify the operating system that the internal ports are not DMA capable. This option is to help with devices that have operating system DMA compatibility issues. This option does not directly enable DMA protection in the operating system.</p> <p><b>NOTE:</b> This option is not available when the virtualization setting for IOMMU is disabled (VT-d/AMD Vi).</p> <p>By default, the <b>Internal Port DMA Compatibility Mode</b> option is disabled.</p> <p><b>NOTE:</b> This option is provided only for compatibility purposes, as certain older hardware may not be DMA compliant.</p> |

**Table 47. System setup options—Performance menu**

| <b>Performance</b>                |  |
|-----------------------------------|--|
| <b>Multi-Core Support</b>         |  |
| Multiple Atom Cores               | <p>Enables to change the number of Atom cores available to the operating system. The default value is set to the maximum number of cores.</p> <p>By default, the <b>All Cores</b> option is selected.</p>                            |
| <b>Intel SpeedStep</b>            |  |
| Enable Intel SpeedStep Technology | <p>Enables the computer to dynamically adjust processor voltage and core frequency, decreasing average power consumption and heat production.</p> <p>By default, the <b>Enable Intel SpeedStep Technology</b> option is enabled.</p> |

**Table 47. System setup options—Performance menu (continued)**

| <b>Performance</b>                             |   |
|--|---|
| <b>C-State Control</b>                         |   |
| Enable C-State Control                         | <p>Enables or disables the ability of the CPU to enter and exit low-power state. When disabled, it disables all C-states. When enabled, it enables all C-states that the chipset or platform allows.</p> <p>By default, the <b>Enable C-State Control</b> option is enabled.</p>  |
| Enable adaptive C-States for Discrete Graphics | <p>Enables or disables the system to dynamically detect and allow high usage of a discrete graphics and adjust system parameters for higher performance during that time period. This feature requires AC adapter due to higher energy consumption and will no dynamically activate higher performance without an appropriate AC adapter powering the system. Other settings made to conserve power may block this feature from activating.</p> <p>By default, the <b>Enable adaptive C-States for Discrete Graphics</b> option is enabled.</p> |
| <b>Intel Turbo Boost Technology</b>            |   |
| Enable Intel Turbo Boost Technology            | <p>Enables the Intel TurboBoost mode of the processor. When enabled, the Intel TurboBoost driver increases the performance of the CPU or graphics processor.</p> <p>By default, the <b>Enable Intel Turbo Boost Technology</b> option is enabled.</p>   |
| <b>Intel Hyper-Threading Technology</b>        |   |
| Enable Intel Hyper-Threading Technology        | <p>Enables the Intel Hyper-Threading mode of the processor. When enabled, the Intel Hyper-Threading increases the efficiency of the processor resources when multiple threads run on each core.</p> <p>By default, the <b>Intel Hyper-Threading Technology</b> option is enabled.</p>   |

**Table 48. System setup options—System Logs menu**

| <b>System Logs</b>       |   |
|--------------------------|---|
| <b>BIOS Event Log</b>    |   |
| Clear BIOS Event Log     | <p>Allows you to select option to keep or clear BIOS events logs.</p> <p>By default, the <b>Keep Log</b> option is selected.</p>    |
| <b>Thermal Event Log</b> |   |
| Clear Thermal Event Log  | <p>Allows you to select option to keep or clear Thermal events logs.</p> <p>By default, the <b>Keep Log</b> option is selected.</p> |
| <b>Power Event Log</b>   |   |
| Clear Power Event Log    | <p>Allows you to select option to keep or clear Power events logs.</p> <p>By default, the <b>Keep Log</b> option is selected.</p>   |

## Updating the BIOS

### Updating the BIOS in Windows

#### About this task

 **CAUTION:** If BitLocker is not suspended before updating the BIOS, the BitLocker key is not recognized the next time you reboot the computer. You will then be prompted to enter the recovery key to proceed, and the



computer displays a prompt for the recovery key on each reboot. Failure to provide the recovery key can result in data loss or an operating system reinstall. For more information, see the Knowledge Base Resource [Updating the BIOS on Dell systems with BitLocker enabled](#).

**CAUTION:** Do not turn off the computer during the BIOS flash update process. The computer may not boot if you turn off your computer.

### Steps

1. Go to [Dell Support Site](#).
2. Go to **Identify your product or ask support**. In the box, enter the product identifier, model, service request or describe what you are looking for, and then click **Search**.  
**NOTE:** If you do not have the Service Tag, click **Detect This PC**. The site automatically detects your device, and you can then click **Explore Product Support** to go to the support page for your device. You can also use the product ID or manually browse for your computer model.
3. Click **Drivers & Downloads**.
4. Select the operating system installed on your computer.
5. In the **Category** drop-down list, select **BIOS**.
6. Select the latest version of BIOS, and click **Download** to download the BIOS file for your computer.
7. After the download is complete, navigate to the folder where the BIOS update file has been saved.
8. Double-click the BIOS update file and follow the on-screen instructions.  
For more information, search in the Knowledge Base Resource at [Dell Support Site](#).

## Updating the BIOS using the USB drive in Windows

### About this task

**CAUTION:** If BitLocker is not suspended before updating the BIOS, the BitLocker key is not recognized the next time you reboot the computer. You will then be prompted to enter the recovery key to proceed, and the computer displays a prompt for the recovery key on each reboot. Failure to provide the recovery key can result in data loss or an operating system reinstall. For more information, see the Knowledge Base Resource [Updating the BIOS on Dell systems with BitLocker enabled](#).

**CAUTION:** Do not turn off the computer during the BIOS flash update process. The computer may not boot if you turn off your computer.

### Steps

1. Go to [Dell Support Site](#).
2. Go to **Identify your product or ask support**. In the box, enter the product identifier, model, service request or describe what you are looking for, and then click **Search**.  
**NOTE:** If you do not have the Service Tag, click **Detect This PC**. The site automatically detects your device, and you can then click **Explore Product Support** to go to the support page for your device. You can also use the product ID or manually browse for your computer model.
3. Click **Drivers & Downloads**.
4. Select the operating system installed on your computer.
5. In the **Category** drop-down list, select **BIOS**.
6. Select the latest version of BIOS, and click **Download** to download the BIOS file for your computer.
7. Create a bootable USB drive. For more information, search the Knowledge Base Resource at [Dell Support Site](#).
8. Copy the BIOS Setup program file to the bootable USB drive.
9. Connect the bootable USB drive to the computer that needs the BIOS update.
10. Restart the computer and press **F12**.
11. Select the USB drive from the **One Time Boot Menu**.
12. Type the BIOS Setup program filename and press **Enter**.

The **BIOS Update Utility** appears.

13. Follow the on-screen instructions to complete the BIOS update.

## Updating the BIOS in Linux and Ubuntu

To update the system BIOS on a computer that is installed with Linux or Ubuntu, see [How to Update the Dell BIOS in the Ubuntu or Linux Environment](#) at [Dell Support Site](#).

## Updating the BIOS from the One-Time boot menu

To update the BIOS from the One-Time boot menu, see Knowledge base article [000128928](#) at [Dell Support Site](#).

## System and setup password

 **CAUTION:** The password features provide a basic level of security for the data on your computer.

 **CAUTION:** Ensure that your computer is locked when it is not in use. Anyone can access the data that is stored on your computer, when left unattended.

**Table 49. System and setup password**

| Password type   | Description   |
|-----------------|---|
| System password | Password that you must enter to boot to your operating system.                        |
| Setup password  | Password that you must enter to access and change the BIOS settings of your computer. |

You can create a system password and a setup password to secure your computer.

 **NOTE:** The System and setup password feature is disabled by default.

## Assigning a System Setup password

### Prerequisites

You can assign a new System or Admin Password only when the status is set to **Not Set**. To enter BIOS System Setup, press F2 immediately after a power-on or reboot.

### Steps

1. To enter the **System Setup**, press **F2** immediately after a power-on or reboot.
2. In the **System BIOS** or **System Setup** screen, select **Security** and press Enter.  
The **Security** screen is displayed.
3. Select **System/Admin Password** and create a password in the **Enter the new password** field.  
Use the following guidelines to create the system password:
  - Password can be up to 32 characters.
  - Password must contain at least one special character: "( ! " # \$ % & ' \* + , - . / : ; < = > ? @ [ \ ] ^ \_ ` { | } )"
  - The password can contain numbers from 0 to 9.
  - The password can contain alphabets A to Z and a to z.
4. Type the system password that you entered earlier in the **Confirm new password** field and click **OK**.
5. Press Y to save the changes.  
The computer restarts.

# Deleting or changing an existing system password or setup password

## Prerequisites

Ensure that the **Password Status** is Unlocked in the System Setup before attempting to delete or change the existing system password and/or setup password. You cannot delete or change an existing system password or setup password if the **Password Status** is Locked. To enter the System Setup, press F2 immediately after a power-on or reboot.

## Steps

1. To enter the **System Setup**, press **F2** immediately after a power-on or reboot.
2. In the **System BIOS** or **System Setup** screen, select **System Security** and press Enter. The **System Security** screen is displayed.
3. In the **System Security** screen, verify that the **Password Status** is Unlocked.
4. Select **System Password**. Update or delete the existing system password, and press Enter or Tab.
5. Select **Setup Password**. Update or delete the existing setup password, and press Enter or Tab.  
 **NOTE:** If you change the system password and/or setup password, reenter the new password when prompted. If you delete the system password and/or setup password, confirm the deletion when prompted.
6. Press Esc. A message prompts you to save the changes.
7. Press Y to save the changes and exit from **System Setup**. The computer restarts.

# Clearing system and setup passwords

## About this task

To clear the system or setup passwords, contact Dell technical support as described at [Contact Support](#).

-  **NOTE:** For information about how to reset Windows or application passwords, see the documentation accompanying Windows or your application.

# Troubleshooting

## Handling swollen rechargeable Li-ion batteries

Like most laptops, Dell laptops use Lithium-ion batteries. One type of Lithium-ion battery is the rechargeable Li-ion battery. Rechargeable Li-ion batteries have increased in popularity in recent years and have become a standard in the electronics industry due to customer preferences for a slim form factor (especially with newer ultra-thin laptops) and long battery life. Inherent to rechargeable Li-ion battery technology is the potential for swelling of the battery cells.

A swollen battery may impact the performance of the laptop. To prevent possible further damage to the device enclosure or internal components leading to malfunction, discontinue the use of the laptop and discharge it by disconnecting the AC adapter and letting the battery drain.

Swollen batteries should not be used and must be replaced and disposed of properly. We recommend contacting Dell Support for options to replace a swollen battery under the terms of the applicable warranty or service contract, including options for replacement by a Dell authorized service technician.

The guidelines for handling and replacing rechargeable Li-ion batteries are as follows:

- Exercise caution when handling rechargeable Li-ion batteries.
- Discharge the battery before removing it from the laptop. To discharge the battery, unplug the AC adapter from the computer and operate the computer only on battery power. The battery is fully discharged when the computer no longer turns on when the power button is pressed.
- Do not crush, drop, mutilate, or penetrate the battery with foreign objects.
- Do not expose the battery to high temperatures, or disassemble battery packs and cells.
- Do not apply pressure to the surface of the battery.
- Do not bend the battery.
- Do not use tools of any type to pry on or against the battery.
- If a battery gets stuck in a device as a result of swelling, do not try to free it as puncturing, bending, or crushing a battery can be dangerous.
- Do not attempt to reassemble a damaged or swollen battery into a laptop.
- Swollen batteries that are covered under warranty should be returned to Dell in an approved shipping container (provided by Dell)—this is to comply with transportation regulations. Swollen batteries that are not covered under warranty should be disposed of at an approved recycling center. Contact Dell Support at [Dell Support Site](#) for assistance and further instructions.
- Using a non-Dell or incompatible battery may increase the risk of fire or explosion. Replace the battery only with a compatible battery purchased from Dell that is designed to work with your Dell computer. Do not use a battery from other computers with your computer. Always purchase genuine batteries from [Dell Site](#) or otherwise directly from Dell.

Rechargeable Li-ion batteries can swell for various reasons such as age, number of charge cycles, or exposure to high heat. For more information about how to improve the performance and lifespan of the laptop battery and to minimize the possibility of occurrence of the issue, search Dell laptop battery at [Dell Support Site](#).

## Dell SupportAssist Pre-boot System Performance Check diagnostics

### About this task

SupportAssist diagnostics (also known as system diagnostics) performs a complete check of your hardware. The Dell SupportAssist Pre-boot System Performance Check diagnostics is embedded within the BIOS and launched by the BIOS internally. The embedded system diagnostics provides options for particular devices or device groups allowing you to:

- Run tests automatically or in an interactive mode.
- Repeat the tests.
- Display or save test results.
- Run thorough tests to add more options and obtain details about any failed devices.

- View status messages that inform you when the tests are completed successfully.
- View error messages that inform you of problems encountered during testing.

**NOTE:** Some tests for specific devices require user interaction. Always ensure that you are present at the computer when the diagnostic tests are performed.

For more information, see [How to Run Dell Preboot Diagnostics and Hardware Tests on Your Dell Computer](#).

## Running the SupportAssist Pre-Boot System Performance Check

### Steps

1. Turn on your computer.
2. As the computer boots, press the F12 key.
3. On the boot menu screen, select **Diagnostics**.  
The diagnostic quick test begins.  
**NOTE:** For more information about running the SupportAssist Pre-Boot System Performance Check on a specific device, see [Dell Support Site](#).
4. If there are any issues, error codes are displayed.  
Note the error code and validation number and contact Dell.

## Built-in self-test (BIST)

### Motherboard Built-In Self-Test (M-BIST)

M-BIST is the system board onboard self-test diagnostics tool that improves the diagnostics accuracy of system board Embedded Controller (EC) failures.

**NOTE:** M-BIST can be manually initiated before Power On Self-Test (POST).

### How to run M-BIST

**NOTE:** Before initiating M-BIST, ensure that the computer is in a power-off state.

1. Press and hold both the **M** key and the power button to initiate M-BIST.
2. The battery-status light may exhibit two states:
  - Off: No fault was detected.
  - Amber and White: Indicates a problem with the system board.
3. If there is a failure with the system board, the battery-status light flashes one of the following error codes for 30 seconds:

**Table 50. LED error codes**

| Blinking Pattern |       | Possible Problem       |
|------------------|-------|------------------------|
| Amber            | White |                        |
| 2                | 1     | CPU Failure            |
| 2                | 8     | LCD Power Rail Failure |
| 1                | 1     | TPM Detection Failure  |
| 2                | 4     | Memory/RAM failure     |

4. If there is no failure with the system board, the LCD cycles through the solid color screens (that are described in the LCD-BIST) for 30 seconds and then turn off.

## Logic Built-in Self-test (L-BIST)

L-BIST is an enhancement to the single LED error code diagnostics and is automatically initiated during POST. L-BIST will check the LCD power rail. If there is no power being supplied to the LCD (that is if the L-BIST circuit fails), the battery status LED flashes either an error code [2,8] or an error code [2,7].

**NOTE:** If L-BIST fails, LCD-BIST cannot function as no power will be supplied to the LCD.

### How to invoke the L-BIST

1. Turn on your computer.
2. If the computer does not start up normally, look at the battery status LED:
  - If the battery status LED flashes an error code [2,7], the display cable may not be connected properly.
  - If the battery status LED flashes an error code [2,8], there is a failure on the LCD power rail of the system board, hence there is no power that is supplied to the LCD.
3. For cases, when a [2,7] error code is shown, check to see if the display cable is properly connected.
4. For cases when a [2,8] error code is shown, replace the system board.

## LCD Built-in Self-Test (LCD-BIST)

Dell laptops have a built-in diagnostic tool that helps you determine if the screen abnormality you are experiencing is an inherent problem with the LCD (screen) of the Dell laptop or with the video card (GPU) and computer settings.

When you notice screen abnormalities like flickering, distortion, clarity issues, fuzzy or blurry image, horizontal or vertical lines, color fade, it is always a good practice to isolate the LCD (screen) by running the LCD-BIST.

### How to invoke the LCD-BIST

1. Turn off your computer.
2. Disconnect any peripherals that are connected to the computer. Connect only the AC adapter (charger) to the computer.
3. Ensure that the LCD (screen) is clean (no dust particles on the surface of the screen).
4. Press and hold the **D** key and press the power button to enter LCD-BIST mode. Continue to hold the **D** key until the computer boots up.
5. The screen displays solid colors and changes colors on the entire screen to white, black, red, green, and blue twice.
6. Then it displays the colors white, black, and red.
7. Carefully inspect the screen for abnormalities (any lines, fuzzy color, or distortion on the screen).
8. At the end of the last solid color (red), the computer shuts down.

**NOTE:** Dell SupportAssist Preboot diagnostics upon launch initiates an LCD-BIST first, expecting a user intervention to confirm functionality of the LCD.

## System-diagnostic lights

This section lists the system-diagnostic lights of your Dell Pro 14 Essential PV14250.

**Table 51. System-diagnostic lights**

| Blinking pattern |       | Problem description                                  |
|------------------|-------|--|
| Amber            | White |  |
| 1                | 1     | TPM detection failure                                |
| 1                | 2     | Unrecoverable SPI Flash Failure                      |
| 1                | 5     | EC unable to program i-Fuse                          |
| 1                | 6     | Generic catch-all for ungraceful EC code flow errors |

**Table 51. System-diagnostic lights (continued)**

| Blinking pattern |       | Problem description  |
|------------------|-------|--|
| Amber            | White |  |
| 2                | 1     | CPU failure  |
| 2                | 2     | System board failure (included BIOS corruption or ROM error) |
| 2                | 3     | No memory or RAM detected                                    |
| 2                | 4     | Memory or RAM failure  |
| 2                | 5     | Invalid memory installed                                     |
| 2                | 6     | System board or Chipset Error                                |
| 2                | 7     | LCD failure (SBIOS message)                                  |
| 2                | 8     | LCD failure (EC detection of power rail failure)             |
| 3                | 1     | CMOS battery failure   |
| 3                | 2     | PCI or Video card or chip failure                            |
| 3                | 3     | BIOS Recovery image not found                                |
| 3                | 4     | BIOS Recovery image found but invalid                        |
| 3                | 5     | Power rail failure   |
| 3                | 6     | Flash corruption is detected by SBIOS.                       |
| 3                | 7     | Timeout waiting on ME to reply to HECI message.              |

**i** **NOTE:** Blinking 3-3-3 LEDs on Lock LED (Caps-Lock or Num-Lock), Power button LED (without Fingerprint reader), and Diagnostic LED indicates failure to provide input during LCD panel test on Dell SupportAssist Pre-boot System Performance Check diagnostics.

## Recovering the operating system

When your computer is unable to boot to the operating system even after repeated attempts, it automatically starts Dell SupportAssist OS Recovery.

Dell SupportAssist OS Recovery is a stand-alone tool that is preinstalled on Dell computers running the Windows operating system. It consists of tools to diagnose and troubleshoot issues that may occur before your computer boots to the operating system. It enables you to diagnose hardware issues, repair your computer, back up your files, and restore your computer to its factory state.

You can also download it from the Dell Support website to troubleshoot and fix your computer when it fails to boot into the primary operating system due to software or hardware failures.

For more information about the Dell SupportAssist OS Recovery, see *Dell SupportAssist OS Recovery User's Guide at Serviceability Tools at the Dell Support Site*. Click **SupportAssist** and then click **SupportAssist OS Recovery**.

**i** **NOTE:** Windows 11 IoT Enterprise LTSC 2024 and Dell ThinOS 10 do not support Dell SupportAssist. For more information about recovering ThinOS 10, see [Recovery mode using R-Key](#).

## Real-Time Clock (RTC Reset)

The Real-Time Clock (RTC) reset function enables you or the service technician to recover Dell computers from No POST/No Power/No Boot situations.

Start the RTC reset with the computer powered off and connected to AC power. Press and hold the power button for twenty-five seconds. The computer RTC Reset occurs after you release the power button.

## Backup media and recovery options

It is recommended to create a recovery drive to troubleshoot and fix problems that may occur with Windows. Dell provides multiple options for recovering the Windows operating system on your Dell computer. For more information, see [Dell Windows Backup Media and Recovery Options](#).

## Network power cycle

### About this task

If your computer is unable to access the Internet due to network connectivity issues, reset your network devices by performing the following steps:

### Steps

1. Turn off the computer.
2. Turn off the modem.  
 **NOTE:** Some Internet service providers (ISPs) provide a modem and router combo device.
3. Turn off the wireless router.
4. Wait for 30 seconds.
5. Turn on the wireless router.
6. Turn on the modem.
7. Turn on the computer.

## Drain flea power (perform hard reset)

### About this task

Flea power is the residual static electricity that remains in the computer even after it has been powered off and the battery is removed.

For your safety, and to protect the sensitive electronic components in your computer, you must drain residual flea power before removing or replacing any components in your computer.

Draining flea power, also known as a performing a "hard reset," is also a common troubleshooting step if your computer does not turn on or boot into the operating system.

Perform the following steps to drain the flea power:

### Steps

1. Turn off the computer.
2. Disconnect the power adapter from the computer.
3. Remove the base cover.
4. Remove the battery.  
 **CAUTION: The battery is a Field Replaceable Unit (FRU) and the removal and installation procedures are intended for authorized service technicians only.**
5. Press and hold the power button for 20 seconds to drain the flea power.
6. Install the battery.
7. Install the base cover.
8. Connect the power adapter to the computer.
9. Turn on the computer.



 **NOTE:** For more information about performing a hard reset, go to [Dell Support Site](#). On the menu bar at the top of the Support page, select Support > Support Library. In the Search field on the Support Library page, type the keyword, topic, or model number, and then click or tap the search icon to view the related articles.

# Getting help and contacting Dell

## Self-help resources

You can get information and help on Dell products and services using these self-help resources:

**Table 52. Self-help resources**

| Self-help resources  | Resource location   |
|--|---|
| Information about Dell products and services   | <a href="#">Dell Site</a>   |
| Contact Support  | In Windows search, type <code>Contact Support</code> , and press Enter.   |
| Online help for operating system   | <a href="#">Windows Support Site</a><br><a href="#">Linux Support Site</a>  |
| Access top solutions, diagnostics, drivers and downloads, and learn more about your computer through videos, manuals, and documents. | Your Dell computer is uniquely identified using a Service Tag or Express Service Code. To view relevant support resources for your Dell computer, enter the Service Tag or Express Service Code at <a href="#">Dell Support Site</a> .<br><br>For more information about how to find the Service Tag for your computer, see <a href="#">Locate the Service Tag on your computer</a> . |
| Dell knowledge base articles   | <ol style="list-style-type: none"> <li>1. Go to <a href="#">Dell Support Site</a>.</li> <li>2. On the menu bar at the top of the Support page, select <b>Support &gt; Support Library</b>.</li> <li>3. In the Search field on the Support Library page, type the keyword, topic, or model number, and then click or tap the search icon to view the related articles.</li> </ol>      |

## Contacting Dell

To contact Dell for sales, technical support, or customer service issues, see [Dell Support Site](#).

 **NOTE:** Availability of the services may vary depending on the country or region, and product.

 **NOTE:** If you do not have an active Internet connection, you can find contact information in your purchase invoice, packing slip, bill, or Dell product catalog.

## Revision history

Tracks all updates that are made to the document. It typically includes the date of change, version number, and a brief description of the modification. This log helps maintain transparency, accountability, and a clear timeline of progress.

**Table 53. Revision history**

| <b>Revision</b> | <b>Date</b> | <b>Description</b>               |
|-----------------|-------------|----------------------------------|
| A00             | 08-29-2025  | Original publish date.           |
| A01             | 11-21-2025  | Battery moved to CRU components. |